

- ACCESSORI PER SMONTAGOMME ALTO DI GAMMA • ACCESSORIES FOR TOP LINE TYRE CHANGERS
- ZUBEHÖR FÜR TOP-REIFENMONTIERMASCHINEN • ACCESSORIES POUR DÉMONTÉ-PNEUS HAUT DE GAMME
- ACCESORIOS PARA DESMONTADORAS TOP DE GAMA

TOP LINE TYRE CHANGER accessories



Montaggio in fabbrica
Factory assembled
Werkseitig montiert
Montage en usine
Montaje en fábrica

Fare riferimento al listino prezzi per i codici degli smontagomme dove utilizzare ogni accessorio.
See pricelist for tyre changer reference applicability for each accessory.
Siehe Preisliste für den genauen Zubehöreinsatz auf Montiermaschinentyp.
Voir le tarif pour les références des démonte-pneus ou utiliser chaque accessoire.
Ver la lista de precios para las referencias de las desmuntadoras donde utilizar cada accesorio.



G1000A142
Utensile di montaggio superiore.
Upper tool.
Obere Montagekopf.
Outil supérieur.
Util superior.



G1000A117
Utensile di montaggio superiore.
Upper tool.
Obere Montagekopf.
Outil supérieur.
Util superior.



G1000A71K (5 x kit)
G1000A134K (5 x kit)
Kit tastatori.
Rim feeler kit.
Satz Taster.
Jeu de palpeurs.
Juego palpadores.



G1000A65 (1 x kit)
G1000A65K (5 x kit)
Protezione supporto utensile superiore.
Protection for upper tool support.
Satz oberer Montagevorrichtung-Schutz.
Protection support outil supérieur.
Protección para util superior.



G1000A66K (5 x kit)
Protezione cono di bloccaggio.
Set of protections of locking cone.
Satz Spannkone Schutz.
Kit protections cône dispositif de blocage.
Juego protecciones cono dispositivo de bloqueo.

G1000A68
Utensile di montaggio inferiore.
Lower tool.
Untere Montagekopf.
Outil inférieur.
Util inferior.



G1000A116
Utensile superiore predisposto per protezione G1000A90K (protezione non inclusa).
Upper tool for protection G1000A90K (protection not included).
Obere Montagekopf einsetzbar mit Kunststoffschutz G1000A90K (Montagekopfkunststoffschutz nicht im Lieferumfang).
Outil supérieur predisposé pour protection G1000A90K (protection pas incluse).
Util superior predisposto para protección G1000A90K (la protección no está incluida).

G1000A90K (50 X kit)
Protezione per G1000A116.
Rim protection for tool G1000A116.
Montagekopfkunststoffschutz für G1000A116.
Protection pour G1000A116.
Juego protecciones p/uña G1000A116.

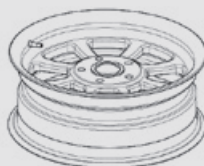

Standard rim

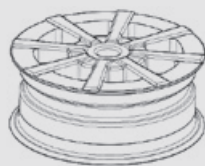

Spoke rim

G1000A142 (1 x kit)
G1000A142K (6 x kit)
Utensile superiore per cerchi con razze sporgenti
Tool head for rims with protruding spokes
Obere Montagenase für gewölbte Felgen
Outil supérieur pour les jantes avec rayons en saillie
Util superior para llantas con radios hacia fuera

G1000A113 (Old)

G1000A142 (New)

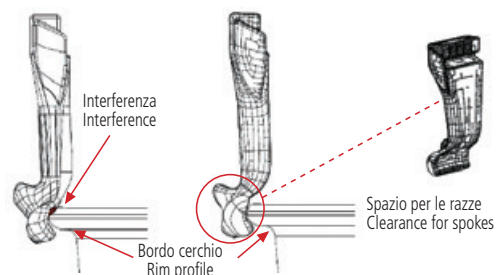

Helper

Dispositivo premitallone rotante pneumatico.
 Rotating arm with pneumatic bead pushing device.
 Drehender pneumatischer Wulstniederhaltearm.
 Bras pousse-talon rotatif pneumatique.
 Brazo prensa talón rotatorio neumático.



PLUS91 AKC
 PLUS91 AKL



PLUS 94

G1000A7
 Rullino premitallone.
 Bead pushing roller.
 Wulstniederhalte Rolle.
 Rouleau pousse-talon.
 Rodillo prensa talón.



PLUS93 - PLUS96

G1000A53
 Leva alzatallone inferiore.
 Lower lever.
 Unteres Montiereisen.
 Levier inférieure.
 Palanca inferior.

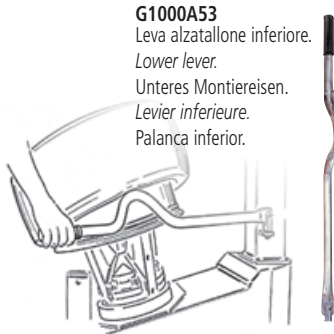

PLUS80 CL
PLUS80 CL/M
 Dispositivo premi-alza tallone pneumatico.
 Air-driven device for bead pushing-raising.
 Pneumatischer Hilfsmontagearm.
 Dispositif pousse-lève talon pneumatique.
 Dispositivo prensa-levanta talón neumático.



STANDARD



WDK



G1000A111
 (→ PLUS 93, PLUS 96, PLUS 91 AKC, PLUS 91 AKL)
G1000A119
 (→ PLUS 94)
 Pressore sagomato WDK.
 WDK bead pressure device.
 WDK-Adapter.
 Outil de pression WDK.
 Prensa talón WDK.



G800A58
 (→ PLUS91AKC + G1000A111)
 (→ PLUS91AKL + G1000A111)
 Trazione per premitallone rotante.
 Traction for rotating bead pushing device.
 Zugvorrichtung für den Hilfsmontagearm.
 Traction pour pousse-talon rotatif.
 Tracción para prensa talón rotatorio.

Puller



G1000A140
 Spingitallone con trascinatore
 Beadpusher with pulling system
 Wulstboy mit Zugvorrichtung
 Tige-pousseur avec cale d'épaisseur
 Empujador de talones con tracción

Puller + Magic Cord

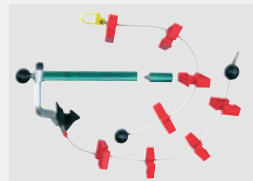

G1000A67 - 28"
 G1000A124 - 28"

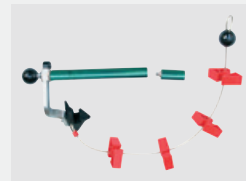

G1000A56 - 22"

Magic Cord

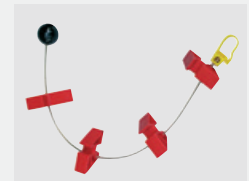

G1000A36

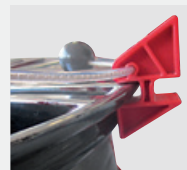

Premitallone con trazione.
 Bead pushing device with pulling system.
 Wulstboy mit Zugvorrichtung.
 Pousse-talon avec traction.
 Prensa talón con tracción.

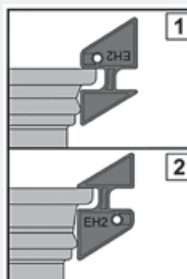

Lato 1 per cerchi normali con balconata corta.
 Side 1 for standard rims with short balcony.
 Site 1 für Standardfelgen mit Kurzem Humb
 Côté 1 pour jantes standard avec rebord court
 Lado 1 para llantas normales con espesor reducido

Lato 2 per cerchi EH2 / EH2+ con balconata lunga.
 Side 2 for EH2 / EH2+ rims with long balcony.
 Seite 2 für EH2 / EH2+ Felgen mit Langem Humb
 Côté 2 pour jantes EH2 / EH2+ avec rebord long
 Lado 2 para llantas EH2/EH2+ con espesor largo

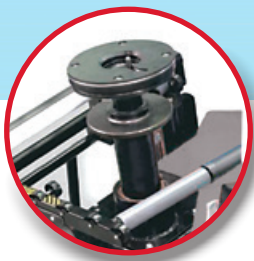

Center locking adapters / Adattatori bloccaggio centrale



G1000A87 (5 x h=70 mm)
Flangia universale per ruote rovesce.
Universal flange for reverse rims.
Universalfansch für Felgen mit versetztem Tiefbett.
Bride universelle pour roues à gorge renversée.
Garra universal para ruedas invertidas.



G1000A72
G1000A137 (5 x h=70 mm)

Flangia universale per ruote senza foro centrale e adatta anche a ruote rovesce.
Universal flange for closed centre, adapted also for reverse rims.
Universalfansch für Räder ohne Mittelloch, geeignet auch für Felgen mit versetztem Tiefbett.
Bride universelle pour roues sans trou central, indiquée aussi pour roues à gorge renversée.
Brida universal para ruedas sin agujero central (lantas ciegas) y indicada para ruedas invertidas.



G1000A72
Foratura singola
Single drilling



G1000A137
(da Dicembre 2016)
(from December 2016)
(ab Dezember 2016)
(de December 2016)
(desde Diciembre 2016)

Foratura doppia
Double drilling



G1000A102 (5 x h=110 mm)
(→ G1000A72, G1000A87, G1000A137)
5 colonnette da 110 mm per ruote rovesce.
5 stud kit 110 mm long for reverse rims.
Satz Bolzen 110 mm für Felgen mit versetztem Tiefbett.
5 doigts de 110 mm pour jantes renversée.
5 espárragos largo 110 mm para ruedas invertidas.

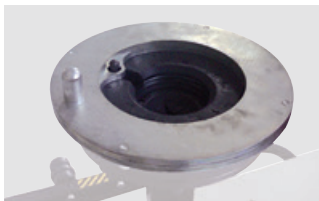

G1000A101
Flangia per autocarri leggeri.
Flange for light trucks.
LLKW-Flansch.
Flasque pour utilitaires.
Garra para camiones ligeros/furgonetas.



G1000A123
Flangia universale per bloccaggio ruote attraverso i fori di fissaggio.
Universal flange for clamping wheels through locking holes.

Universaltypenflansch mit Bolzenfixierung.
Flasque universelle pour blocage de roue par les trous de fixation.
Garra universal para bloqueo de rueda a través de los agujeros de fijación.



G1000A92 - Ø 50 mm - G1000A126 - Ø 69 mm
(→ G1000A80, G1000A138)

Cono per albero D.40 con distanziale.
Cône for D.40 shaft with spacer.
Konus für 40-er Welle mit Distanzring.
Cône avec cale pour arbre diam.40.
Cono para eje D.40 con espesor.

Tulip clamping accessories / Accessori bloccaggio a tulipano



G1000A19
Set coperture in ferro per tamponi.
Steel rim adapter.
Stahlfelgenadapter.
Adaptateurs pour jantes en tôle.
Adaptadores para llantas de hierro.



G1000A20
Kit griffe EVO 17,5" (per trasporto leggero).
External jaws for 17.5" light truck.
17,5" LLKW-Spannbacken.
Adaptateurs pour jantes VUL 17,5" en tôle.
Adaptadores llantas hierro 17,5" .



G1000A18
Kit moto.
Motorcycle Kit.



G1000A21
Appoggio ruote registrabile.
Adjustable wheel support with threaded connection.
Einstellbarer Radhalter mit Gewinde.
Appui roue réglable attache à vis.
Soporte rueda regulable con enganche-tornillo.



G1000A42
Dispositivo di sicurezza con supporto.
Safety kit with support.
Satz Sicherheitsvorrichtung mit Halterung.
Kit dispositif de sécurité avec support.
Juego dispositivo de seguridad con soporte.

Inflation booster Gonfiaggio rapido



VAR G60PSI
(Leverless tyre changers → included standard)
Valvola di gonfiaggio rapido.
Quick inflation valve.
Schnellaufpumpventil.
Soupape de gonflage rapide.
Válvula de inflado rápido.

Tyre inflation devices Dispositivi di gonfiaggio



G1000A46
Gonfiatore elettronico digitale con vaschetta porta-oggetti integrata.
Montaggio in fabbrica.
Automatic digital inflator with tool box. Factory installed.
Digitaler automatischer Reifenfüller. Werksseitig montiert.
Dispositif de gonflage digital automatique avec casier. Monté en usine.
Inflador digital automático con caja incluida. Montado en fabrica.



**G1000A51
G800A120**
Variante gonfiaggio con comando a pedale, manometro e valvola bilanciatrice.
Assemblaggio in fabbrica.
Pedal activated inflator, gauge and balancing valve. Factory installed.
Pedalgesteuerter Reifenfüller mit Manometer und Druckregler. Werksseitig montiert.
Variante gonflage commande à pédale, manomètre et valve de dosage. Monté en usine.
Suplemento para inflado con mando a pedal, manómetro y válvula repartidora. Montado en fabrica.

Various / Vari

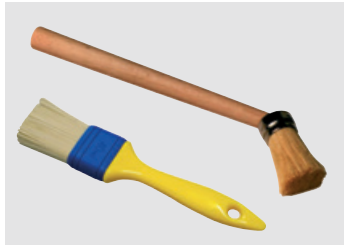

G800A38
Pennello.
Brush.
Schmierpinsel.
Pinceau.
Brocha.

G108A16
Pennello angolare in legno.
Angular wooden brush.
Holz-Schmierpinsel.
Pinceau angulaire en bois.
Brocha profesional de madera.



G800A37 (3,5 kg / 8lbs)
Pasta di montaggio.
Mounting grease.
Montagepaste.
Pâte de montage.
Jabón profesional.

NOTE:
8 x carton
160 x pallet

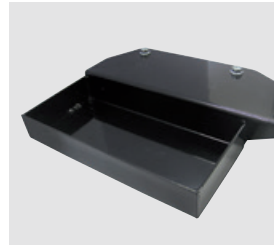

G1000A96
Vaschetta portaoggetti.
Storage tray.
Werkzeugablage.
Bac porte-outils.
Contenedor para herramientas.

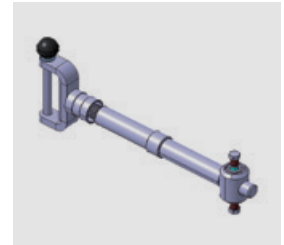

G1000A115
Limitatore corsa stallonatore.
Bead-breaker stroke limiter.
Abdrückschaufelbegrenzer.
Limiteur de course détalonneur.
Limitador de carrera destalonador.



G1000A121
Per ampliare il campo di lavoro fino a 28".
To expand the working range up to 28".
Um den Arbeitsbereich bis 28" zu erweitern.
Pour étendre le champ de travail jusqu'à 28".
Para ampliar el campo de trabajo hasta 28".



G1000A118
Rullo Matching
Matching Roller



G1000A86
Specchio
Mirror
Spiegel
Mirroir
Espejo

Quick locking

 <p>Bloccaggio rapido. Quick locking. Schnellspannung. Blocage rapide. Bloqueo rapido.</p> <p>Old</p> <p>G1000A80 G1000A80/S</p>	 <p>G1000A80</p> <p>Foratura singola Single drilling</p>	 <p>New Easy Lock</p> <p>G1000A138 G1000A138/S</p>	 <p>G1000A138</p> <p>Foratura doppia Double drilling</p>	<p>(da Dicembre 2016) (from December 2016) (ab Dezember 2016) (de Decembre 2016) (desde Diciembre 2016)</p>
-----------------------------------------------------------------------------------------------------------------------------------------------------------------------------------------------------------------------------------------------------	------------------------------------------------------------------------------------------------------------------------------------------------------	---------------------------------------------------------------------------------------------------------------------------------------------------------------	-------------------------------------------------------------------------------------------------------------------------------------------------------	-----------------------------------------------------------------------------------------------------------------------------



G1000A84K (5 x kit)
(→ G1000A80)
(→ G1000A138)

Protezione cono di bloccaggio.
Set of protections of locking cone.
Satz Spannkone Schutz.
Kit protections cône de blocage.

Juego protecciones cono.



G1000A70K (5 x kit)

Protezione trascinato.
Set of protections for lug nut pin.
Satz Schutz Zugvorrichtung.
Kit protections dé d'entraînement.

Juego protecciones arrastrador.



G1000A81K (10 x kit)

Protezione ruote rovesce in gomma.
Set of rubber protections for support plate.
Satz Scheiben-Schutz (Gummi).
Kit protections plateau en caoutchouc.

Juego protecciones platillo de goma.

Wheel lift

Sollevatore pneumatico ruote.
Pneumatic wheel lift.
Pneumatischer Radheber.
Élévateur pneumatique de roue.
Elevador neumático ruedas.

G1000A136

G1000A136/S 



**G1000A99NP
G1000A129NP
G800A121NP**

G1000A112
(→ PLUS96)
G1000A127
(→ PLUS93)



Belt / Cinghia



G1000A40

Kit cinghia inserisci tallone.
Belt kit for bead insertion.
Montage Gurt.
Kit sangle pousse-talon.
Juego cinturón para fácil puesta del talón.



Quando la ruota gira, la cinghia tira il tallone nel canale per facilitare il montaggio.

When rotating the wheel, the belt pulls the bead into the drop center to allow easy mounting.

Beim Radumdrehen zieht der Gurt die Wulst ins Felgenbett und erleichtert die Montage.

Avec la rotation de la roue, la sangle tire le talon dans le creux de jante et facilite le montage.

Quando la ruota da voltas, el cinturón empuja el talón en la garganta y facilita el montaje.

Tools / Utensili



G1000A14

Utensile in plastica auto.
Car plastic tool.
PKW-Kunststoffmontagekof.
Tête en matériel synthétique VL.
Útil en plástico turismos.



G1000A15

Utensile in plastica moto.
Motorbike plastic tool.
Motorrad-Kunststoffmontagekof.
Tête en matériel synthétique moto.
Útil en plástico motos.



G1000A23
G1000A132

Moltiplicatore di forza.
Force multiplier.
Montagekopf-Kraftverstärker.
Multiplicateur de force.
Multiplicador de fuerza.



G1000A128

Dispositivo registrazione altezza utensile.
Device for adjusting tool height.
Höheneinstellvorrichtung des
Montagewerkzeugs.
Dispositif pour l'enregistrement de l'hauteur
de l'outil.
Dispositivo de regulación de altura del útil.



G1000A29

Braccio con attacco rapido.
Quick change shaft and tool.
Schnellsteckvorrichtung.
Kit de remplacement rapide
de la tête.
Conexión rápida para útil.

Bead Levers / Leva Alzatalloni



G1000A11

Leva alzatalone arcuata.
Half moon bead lever.
Halbmondmontiereisen.
Levier demi-lune.
Palanca levanta-talón en forma de "plátano".



G1000A52

Leva alza tallone standard.
Standard bead lever.
Standardmontiereisen.
Levier standard.
Palanca levanta talón estándar.



G1000A54

Porta leva extra.
Bead lever support kit.
Montiereisenhalter.
Kit porte-levier.
Juego porta palanca.

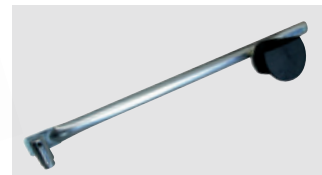

G1000A24

Leva matching.
Matching rod.
Satz Matching.
Kit matching.
Juego para matching.

Protections / Protezioni



G1000A12K (50 x kit)
(→ G1000A14)

Protezione cerchi per utensile di montaggio.
Rim protection for mounting head.
Montagekopfschutz.
Protection de roues pour tête de montage.
Protección llantas para útil de desmontaje.

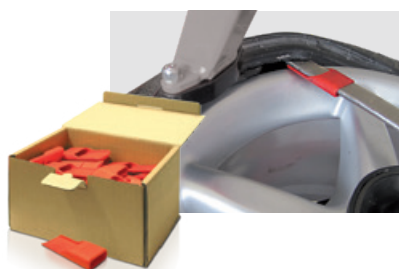

G1000A13K (50 x kit) (→ G1000A11 - G1000A52)

Confezione protezioni leva alzataloni.
Bead lever protection package.
Satz Montagehebel-Alufelgenschutz.
Boîte de protections levier.
Confección protecciones palanca.



G1000A100K (50 x kit)

Confezione di protezioni tallone RFT (direttiva WDK).
Bead protections for RFT (WDK standard).
WDK-Kit.
Boîte de protections talon RFT (norme WDK).
Juego de protecciones talón ruedas RFT (norma WDK).



G800A32

Protezione tallone per pneumatici "Run Flat".
Run Flat bead protection.
Felgenhornwulstschutz für "Run Flat-Reifen".
Protection talon pour pneus "Run Flat".
Protección talón para neumáticos "Run Flat".



G800A11

Protezione paletta stallonatore.
Bead breaker blade protection.
Abdrückschafelschutz.
Protection détalonneur.
Protección paleta destalonadora.
G800A11K - Kit 5 x G800A11

