

HELLA BLACK MAGIC

LED CURVED LIGHT BAR

MONTAGEANLEITUNG

INSTALLATION INSTRUCTION

INSTRUCTIONS DE MONTAGE

MONTERINGSANVISNING

MONTAGEHANDLEIDING

INSTRUCCIONES DE MONTAJE

ISTRUZIONI DI MONTAGGIO

ASENNUSOHJE

INSTRUÇÕES DE INSTALAÇÃO

INSTRUKCJA MONTAŻU

KURULUM TALIMATLARI

تعليمات التركيب

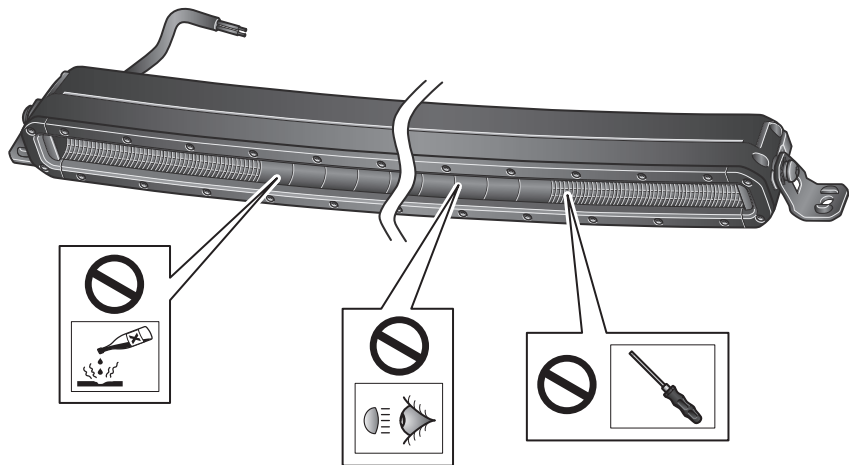

DE PRODUKTHAFTUNG

- Es sind die nationalen Anbau-, Einbau- und Betriebsvorschriften zu beachten und einzuhalten.
- Lesen Sie bitte vor Gebrauch des Gerätes alle beigelegten Anleitungen und Sicherheits-hinweise.
- Im Zuge von Produktverbesserung behalten wir uns technische und optische Änderungen vor.
- Verwenden Sie nur die Originalersatzteile bzw. nur Ersatzteile die von HELLA freigegeben sind.
- Bei Fragen oder Einbauproblemen, wenden Sie sich bitte an den HELLA Kundendienst, den Großhändler oder an Ihre Werkstatt.
- Weitere Informationen finden Sie auch auf unserer Internetseite (www.hella.com/techworld)

EN PRODUCT LIABILITY

- National mounting, fitting and operating regulations must be heeded and kept.
- Please read all the instructions and safety notes included before using the device.
- We reserve the right to make technical and optical modifications within the course of product improvement.
- Only use original spare parts or spare parts approved by HELLA.
- If you have any questions or problems with the installation, please contact HELLA Customer Services, a wholesaler or your garage.
- Further information is available on our website (www.hella.com/techworld)

FR RESPONSABILITÉ PRODUIT

- Les prescriptions nationales en matière de montage et de service doivent être observées et respectées.
- Avant d'utiliser l'appareil lire toutes les instructions de montage et de service fournies ainsi que les conseils de sécurité.
- Dans le cadre de l'amélioration continue de nos produits, nous nous réservons le droit de réaliser des modifications sur les plans technique et optique.
- Utilisez uniquement des pièces d'origine ou des pièces de rechange validées par HELLA.
- Pour toute question ou en cas de problèmes de montage, veuillez contacter le S.A.V. ou le distributeur HELLA ou bien vous adresser à votre garagiste.
- Vous trouverez également des informations complémentaires sur notre site Internet (www.hella.com/techworld)

SV PRODUKTANSVAR

- De nationella monterings-, installations- och driftföreskrifterna ska beaktas och följas.
- Läs alla medföljande instruktioner och säkerhetsanvisningar innan du använder apparaten.
- Vi förbehåller oss rätten till tekniska och optiska ändringar som förbättrar produkten.
- Använd endast original reservdelar resp. endast reservdelar som har godkänts av HELLA.
- Vid frågor eller monteringsproblem, kontakta HELLA kundtjänst, grossisten eller din verkstad.
- Mer information finns också på vår webbplats (www.hella.com/techworld)

NL PRODUCTAANSPRAKELIJKHEID

- Men dient de nationale aanbouw-, inbouw- en bedrijfsvoorschriften in acht te nemen en na te leven.
- Lees a.u.b. alvorens het apparaat te gebruiken alle bijgevoegde gebruiksaanwijzingen en veiligheidsinstructies door.
- In het kader van de productver-betering behouden wij ons technische en optische veranderingen voor.
- Gebruik uitsluitend de originele reserveonderdelen, die door Hella vrijgegeven zijn.
- Neem bij vragen of inbouwproblemen contact op met de HELLA klantenservice, de groothandel of het garagebedrijf.
- Meer informatie is ook te vinden op onze website (www.hella.com/techworld)

ES RESPONSABILIDAD CIVIL POR PRODUCTOS DEFECTUOSOS

- Tienen que observarse y cumplirse con las prescripciones nacionales sobre construcciones anexas, de montaje y de funcionamiento.
- Rogamos que antes de usar el aparato lean todas las instrucciones y advertencias sobre la seguridad adjuntas.
- En aras de la mejora de los productos, nos reservamos el derecho de hacer modificaciones técnicas y ópticas.
- Use sólo recambios originales o bien sólo recambios autorizados por HELLA.
- En caso de dudas o preguntas a la hora del montaje, llame al servicio de atención al cliente de HELLA o diríjase a su Distribuidor o Taller.
- Encontrará más información en nuestra página web (www.hella.com/techworld)

IT RESPONSABILITÀ PER IL PRODOTTO

- Si devono rispettare tutte le normative nazionali di attacco, montaggio e funzionamento.
- Prima di usare l'apparecchio, legga per favore tutte le istruzioni e le avvertenze di sicurezza allegate.
- Nell'ambito del perfezionamento del prodotto, ci riserviamo modifiche tecniche ed estetiche.
- Utilizzare solo pezzi di ricambio originali risp. pezzi autorizzati dalla HELLA.
- Per eventuali domande o problemi di installazione contattare l'Assistenza Clienti HELLA, il grossista o rivolgersi alla propria officina.
- Ulteriori informazioni sono disponibili anche sul nostro sito web (www.hella.com/techworld)

FI TUOTEVASTUU

- Kansalliset asennus- ja käyttöohjeet on huomioitava ja niitä on noudatettava.
- Lue ennen laitteen käyttöä kaikki oheistetut käyttö- sekä turvaohjeet.
- Jatkuvasta tuotekehittelystä johtuen pidätämme oikeuden teknisiin ja optisiin muutoksiin.
- Käytä vain alkuperäisiä tai HELLA hyväksymiä varaosia.
- Jos sinulla on kysyttävää tai asennusongelmia, käänny HELLA-asiakaspalvelun, tukkuliikkeen tai korjaamon puoleen.
- Lisätietoja löytyy verkkosivustoltamme (www.hella.com/techworld).

PT RESPONSABILIDADE DO PRODUTO

- Devem ser cumpridas as prescrições nacionais que visam a montagem e a operação.
- Antes de utilizar o aparelho deve-se ler todas as instruções e avisos de segurança fornecidos.
- Reservamo-nos o direito de alterações técnicas e óticas no âmbito dos processos de melhoramento e de aperfeiçoamento dos produtos.
- Utilizar exclusivamente peças sobressalentes originais ou peças sobressalentes que tenham sido autorizadas e validadas pela HELLA.
- Contacte o serviço de assistência da HELLA, o revendedor grossista ou a oficina do seu concessionário, no caso de dúvidas ou problemas durante a montagem.
- Mais informações estão disponíveis em nosso site (www.hella.com/techworld)

PL ODPOWIEDZIALNOŚĆ ZA PRODUKT

- Przestrzegać krajowych przepisów dotyczących montażu i użytkowania.
- Przed użyciem urządzenia przeczytać wszystkie dołączone instrukcje i zasady bezpieczeństwa.
- Zastrzegamy sobie prawo do wprowadzania zmian technicznych i wizualnych w ramach ulepszania produktu.
- Stosować wyłącznie oryginalne części zamienne lub części zamienne dopuszczone przez firmę HELLA.
- W razie pytań lub problemów z zamontowaniem należy skontaktować się z działem obsługi klienta firmy HELLA, ze sprzedawcą lub autoryzowanym warsztatem.
- Więcej informacji można również znaleźć na naszej stronie internetowej (www.hella.com/techworld)

TR ÜRÜN SORUMLULUĞU

- Dışa montaj, içe montaj ve işleme ilişkin ulusal yönetmelikler dikkate alınmalı ve bunlara uyulmalıdır.
- Cihazı kullanmaya başlamadan önce, birlikte verilen tüm kılavuzları ve güvenlik uyarılarını lütfen okuyun.
- Ürün geliştirme çalışmaları kapsamında, teknik ve görsel değişiklikler yapma hakkımız saklıdır.
- Yalnız orijinal yedek parçalar veya HELLA tarafından onaylanmış olan yedek parçalar kullanın.
- Sorularınız olması durumunda veya montaj problemlerinde, toptancılara için HELLA müşteri hizmetlerini telefonla arayın veya yetkili servise başvurun.
- Daha fazla bilgi web sitemizde mevcuttur (www.hella.com/techworld)

AR

المسؤولية عن المنتج

- يجب الالتزام بالوائح المحلية السارية فيما يتعلق بالتركيب في الخارج أو في الداخل وبلوائح التشغيل.
- قبل استعمال الجهاز احرص على قراءة جميع الكتيبات المرفقة وإرشادات السلامة.
- لتطویر المنتجات فإننا نحتفظ بحق إدخال تغييرات تقنية وشكلية.
- يجب ألا تستخدم سوى قطع الغيار الأصلية أو قطع الغيار التي صرحت HELLA باستخدامها.
- إذا كان لديك أسئلة، أو إذا واجهت مشكلة أثناء التركيب، تفضل بالاتصال بمركز خدمة HELLA، أو بتاجر الجملة أو توجه إلى الورشة الفنية التي تتعامل معها.
- يتوفر مزيد من المعلومات على موقعنا (www.hella.com/techworld)

Zeichenerklärung
Explanation symbols
Explication des symboles
Symbolförklaring

Legenda
Aclaración de símbolos
Legenda
Piirroksen selitys

Símbolos de explicação
Objasnienie symboli
Simgelerin açıklamaları
شرح الرموز



(DE) Richtig

(DE) Falsch

(DE) Positionspfeil

(DE) Bewegungspfeil

(EN) Correct

(EN) Incorrect

(EN) Location/Position Arrow

(EN) Movement Arrow

(FR) Correct

(FR) Incorrect

(FR) Flèche de Position

(FR) Flèche indiquant
sens du mouvement

(SV) Rätt

(SV) Fel

(SV) Positionpil

(SV) Rörelsepil

(NL) Goed

(NL) Fout

(NL) Lokatie/Positie pijl

(NL) Richtingspijl

(ES) Correcto

(ES) Erróneo

(ES) Flecha de posición

(ES) Flecha de movimiento

(IT) Giusto

(IT) Sbagliato

(IT) Freccia di posizione

(IT) Freccia di movimento

(FI) Oikein

(FI) Väärin

(FI) Paikannusnuoli

(FI) Liikesuuntanuoli

(PT) Correcto

(PT) Incorreto

(PT) Seta de localização/posição

(PT) Seta de movimento

(PL) Prawidłowo

(PL) Nieprawidłowo

(PL) Strzałka lokalizacji/położenia

(PL) Strzałka ruchu

(TR) Doğru

(TR) Yanlış

(TR) Yer/Konum Oku

(TR) Hareket Oku

صحيح **(AR)**

خطأ **(AR)**

سهم الموضع/المكان **(AR)**

سهم اتجاه الحركة **(AR)**

Zeichenerklärung
Explanation symbols
Explication des symboles
Symbolförklaring

Legenda
Aclaración de símbolos
Legenda
Piirroksen selitys

Símbolos de explicação
Objasnienie symboli
Simgelerin açıklamaları
شرح الرموز



(DE) Achtung
(EN) Warning
(FR) Attention
(SV) Varning
(NL) Let op
(ES) Atención
(IT) Attenzione
(FI) Huomio
(PT) Aviso
(PL) Ostrzeżenie
(TR) Uyarı
تحذير **(AR)**

(DE) Abklemmen
(EN) Disconnect
(FR) Déconnecter
(SV) Koppla los
(NL) Demonteren
(ES) Desconectar
(IT) Staccare
(FI) Irrota
(PT) Desligar
(PL) Rozłącz
(TR) Bağlantıyı Kes
افصل **(AR)**

(DE) Verbinden
(EN) Connect
(FR) Connecter
(SV) Ansult
(NL) In elkaar
(ES) Conectar
(IT) Collegare
(FI) Yhdistä
(PT) Ligar
(PL) Połącz
(TR) Bağlan
وصل **(AR)**

(DE) Siehe
(EN) Look/See
(FR) Voir
(SV) Se
(NL) Kijkjen naar
(ES) Ver
(IT) Vedere
(FI) Katso
(PT) Ver
(PL) Zobacz/patrz
(TR) Bak/Gör
انظر **(AR)**

Zeichenerklärung
Explanation symbols
Explication des symboles
Symbolförklaring

Legenda
Aclaración de símbolos
Legenda
Piirroksen selitys

Símbolos de explicação
Objasnienie symboli
Simgelerin açıklamaları
شرح الرموز



- (DE)** Nur Fachpersonal
(EN) Only qualified personnel
(FR) Personnel qualifié uniquement
(SV) Endast fackpersonal
(NL) Alleen gekwalificeerd personeel
(ES) Solo personal cualificado
(IT) Solo personale specializzato
(FI) Vain ammattilaiset
(PT) Apenas pessoal qualificado
(PL) Tylko wykwalifikowany personel
(TR) Sadece kalifiye personel
(AR) الموظفين المؤهلين فقط



- (DE)** Fernlicht
(EN) High beam
(FR) Feu de route
(SV) Fjärrljus
(NL) Groot licht
(ES) Luz de carretera
(IT) Luce abbagliante
(FI) Kaukovalo
(PT) Feixe alto
(PL) Światło drogowe
(TR) Uzun far
(AR) شعاع عالي

Lieferumfang
Scope of delivery
Fourniture
Leveransomfattning

Leveringsomvang
Alcance de suministro
Contenuto della confezione
Toimituksen sisältö

Volume de fornecimento
Elementy zestawu
Teslimat kapsamı

الأجزاء المُوردة

ECE

1FJ 358 196-501

1FJ 358 196-511

1FJ 358 196-521

Non ECE

1GJ 358 197-501

1GJ 358 197-511

1GJ 358 197-521

1GJ 358 197-531

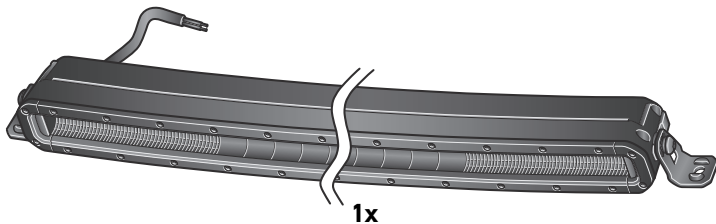

2x



2x



2x



2x



2x

Zubehör
Accessories
Accessories
Tillbehör

Toebehoren
Accessorios
Accessori
Lisätarvikkeet

Acessórios
Aksesoria
Aksesuarlar

الملحقات التكميلية



8KW 732 580-003



8KW 732 567-003



1A 8JS 711 683 - 831
2A 8JS 711 683 - 841
3A 8JS 711 683 - 821

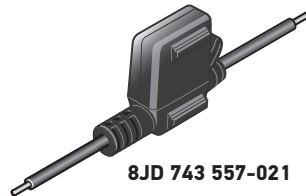

8JD 743 557-021

8HG 358 176-371

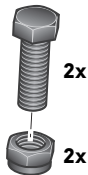

2x

2x



2x

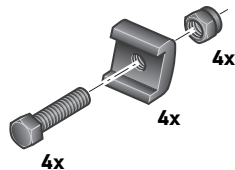

4x

4x

4x

Benötigte Montagewerkzeuge
Installation tools required
Outillage de montage requis
Nödvändiga monteringsverktyg

Benodigde montagewerktuigen
Herramientas de montaje necesarias
Attrezzi necessari per il montaggio
Tarvittavat asennustyökalut

Ferramentas de instalação necessárias
Wymagane narzędzia montażowe
Kurulum aletleri gereklidir
أدوات التركيب المطلوبة



4



13



Ø8,5 mm

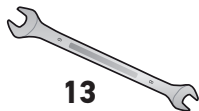

13

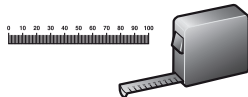
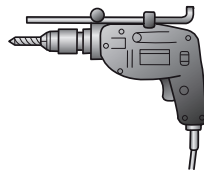
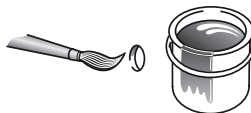

0 10 20 30 40 50 60 70 80 90 100

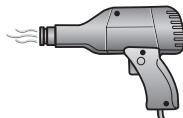

Montage
Mounting
Montage Général
Montering

Montage
Montaje
Montaggio
Asennus

Montagem
Mocowanie
Montaj

التركيب

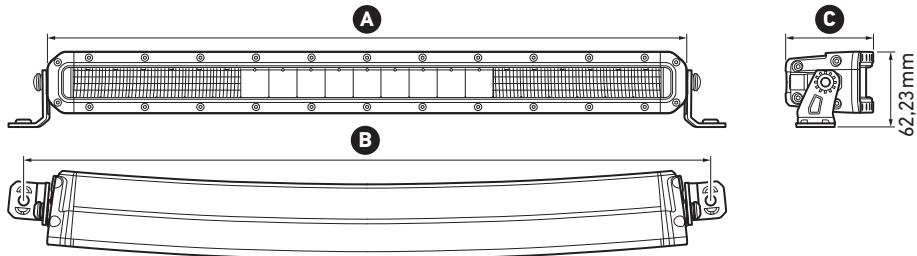

	A	B	C
1FJ 358 196-501	529 mm	568 mm	73 mm
1FJ 358 196-511	806 mm	842 mm	88 mm
1FJ 358 196-521	1013 mm	1046 mm	104 mm
1GJ 358 197-501	529 mm	568 mm	73 mm
1GJ 358 197-511	806 mm	842 mm	88 mm
1GJ 358 197-521	1013 mm	1046 mm	104 mm
1GJ 358 197-531	1286 mm	1316 mm	131 mm

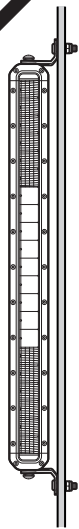
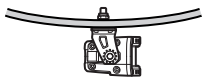
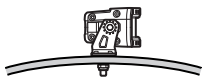
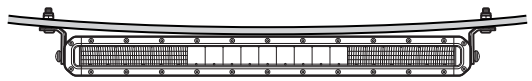
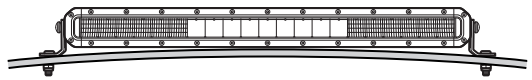
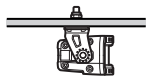
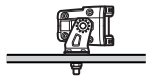
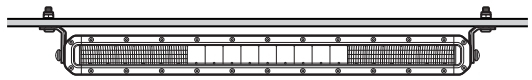
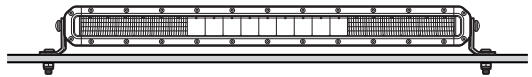

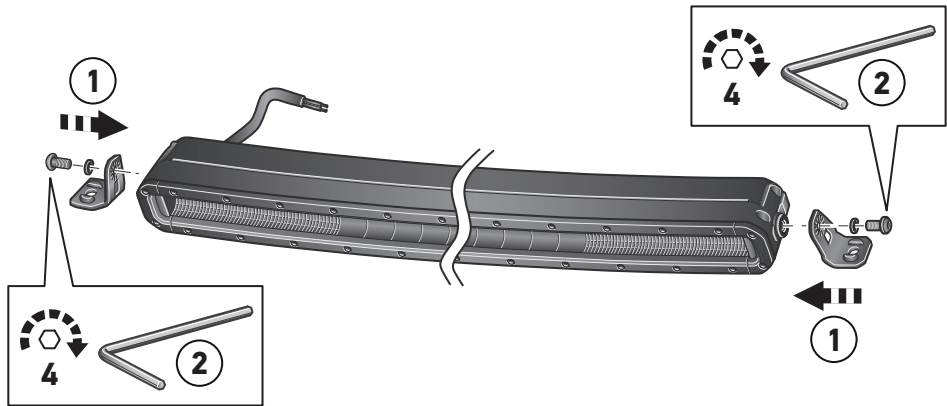



- DE** Vor der Montage am Fahrzeug ist kundenseitig sicherzustellen, dass der Montageuntergrund - /Träger hierfür geeignet ist.
- EN** Before mounting on the vehicle, the customer must ensure that the mounting surface / support is suitable for this purpose.
- FR** Avant le montage sur le véhicule, le client doit s'assurer que le support de montage est approprié.
- SV** Innan montering på fordonet måste kunden försäkra sig om att monteringsytan/stödet är lämpligt för detta ändamål.
- NL** Alvorens tot montage op het voertuig over te gaan, moet de klant zich ervan vergewissen dat het montageoppervlak / de steun daarvoor geschikt is.
- ES** Antes de realizar el montaje en el vehículo, el cliente debe asegurarse de que la superficie de montaje/sopORTE es adecuada para ello.
- IT** Prima del montaggio sul veicolo, il cliente deve assicurarsi che la superficie di montaggio/il supporto siano adatti a questo scopo.
- FI** Ennen asennusta ajoneuvon asiakkaan on varmistettava, että asennuspinta/tuki soveltuu tähän tarkoitukseen.
- PT** Antes de montar no veículo, o cliente deve certificar-se de que a superfície de montagem / suporte é adequada para este fim.
- PL** Przed montażem na pojeździe klient musi się upewnić, że powierzchnia montażowa / podpora jest do tego celu odpowiednia.
- TR** Araca monte etmeden önce, müşteri montaj yüzeyinin / desteğinin bu amaç için uygun olduğundan emin olmalıdır.

قبل التركيب على السيارة ، يجب على العميل التأكد من أن سطح التركيب / القصور الذاتي مناسب لهذا الغرض.

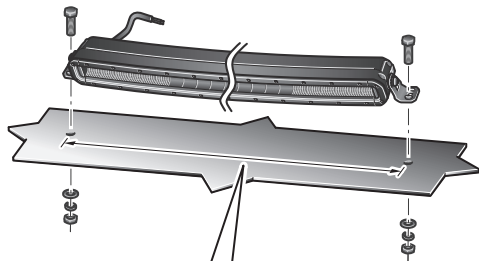
 **18**



1FJ 358 196-501	567.98 mm
1FJ 358 196-511	841.99 mm
1GJ 358 197-501	567.98 mm
1GJ 358 197-511	567.98 mm

 **19 - 20**

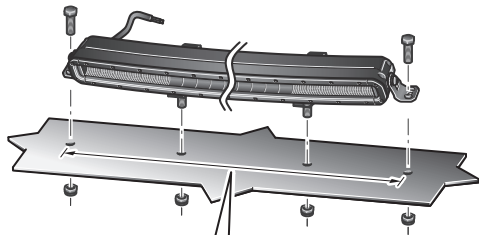

1FJ 358 196-521	1046.25 mm
1GJ 358 197-521	1046.25 mm
1GJ 358 197-531	1315.94 mm

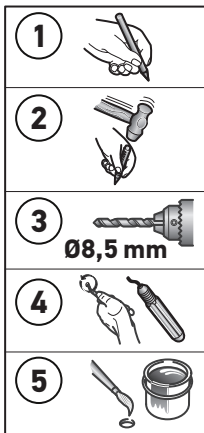

1FJ 358 196-501	568 mm
1FJ 358 196-511	842 mm
1GJ 358 197-501	568 mm
1GJ 358 197-511	568 mm

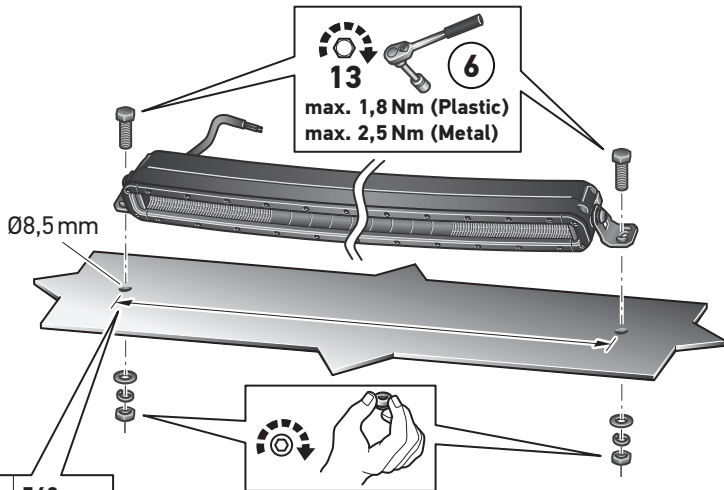

DE (Metall) (Kunststoff)	IT (Metallo) (Plastica)
EN (Metal) (Plastic)	FI (Metalli) (Muovi)
FR (Métal) (Plastique)	PT (Metal) (Plástico)
SV (Metall) (Plast)	PL (Metal) (Plastikowy)
NL (Metaal) (Kunststof)	TR (Metal) (Plastik)
ES (Metal) (Plástico)	AR (معدن) (بلاستيك)

1FJ 358 196-521

1GJ 358 197-521

1GJ 358 197-531

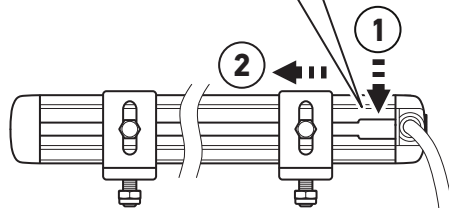
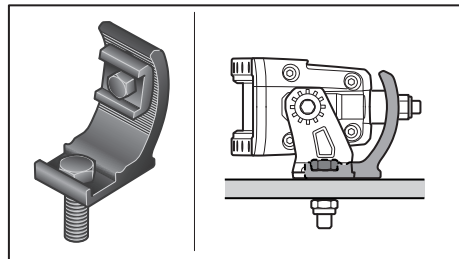
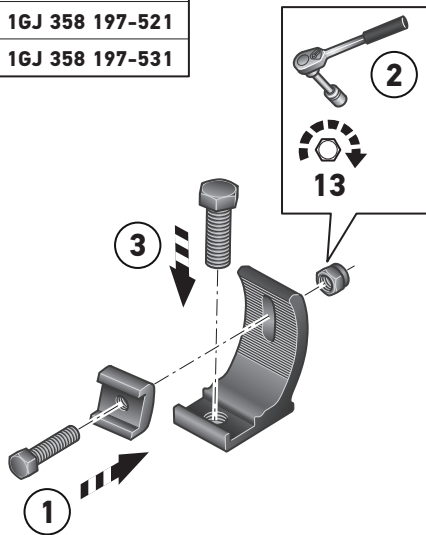

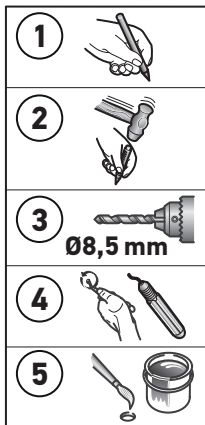

1FJ 358 196-521	1046 mm
1GJ 358 197-521	1046 mm
1GJ 358 197-531	1315 mm

DE (Metall) (Kunststoff)
EN (Metal) (Plastic)
FR (Métal) (Plastique)
SV (Metall) (Plast)

NL (Metaal) (Kunststof)
ES (Metal) (Plástico)
IT (Metallo) (Plastica)
FI (Metalli) (Muovi)

PT (Metal) (Plástico)
PL (Metal) (Plastikowy)
TR (Metal) (Plastik)
AR (معدن) (بلاستيك)

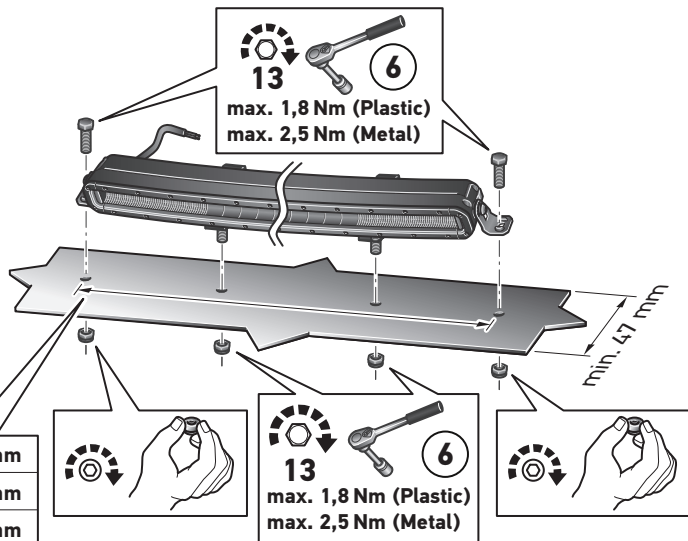

Elektrischer Anschluss
Electrical connection
Branchement électrique
Elektrisk anslutning

Elektrische aansluiting
Conexión eléctrica
Collegamento elettrico
Osaluuttelo

Ligação eléctrica
Połączenia elektryczne

الوصلة الكهربائية

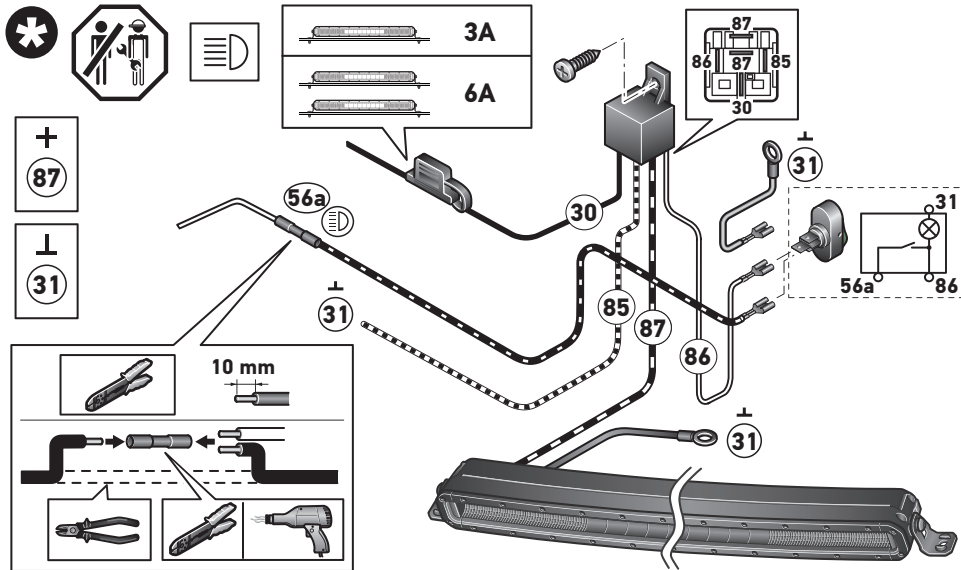

Elektrischer Anschluss
Electrical connection
Branchement électrique
Elektrisk anslutning

Elektrische aansluiting
Conexión eléctrica
Collegamento elettrico
Osaluettelo

Ligação eléctrica
Połączenia elektryczne

الوصلة الكهربائية



- (DE)** Installation Beispiel ECE
- (EN)** Example of installation ECE
- (FR)** Exemple d'installation ECE
- (SV)** Exempel på installation ECE
- (NL)** Voorbeeld van een installatie ECE
- (ES)** Ejemplo de instalación ECE
- (IT)** Esempio di installazione ECE
- (FI)** Esimerkki asennus ECE
- (PT)** Exemplo de instalação ECE
- (PL)** Przykład instalacji ECE
- (TR)** Kurulum örneği ECE
- (AR)** مثال على التثبيت ECE

DE Informationstext	25
EN Information Text	26
FR Texte d'information	27
SV Informationstext	28
NL Informatie tekst	29
ES Texto informativo	30
IT Informazioni	31
FI Ohjetekstit	32
PT Texto informativo	33
PL Tekst informacyjny	34
TR Bilgi Metni	35

DE TECHNISCHE DATEN

	Nennspannung	Spannungsbereich	Eingangswerte	Zulässige Umgebungstemperatur	Schutzklasse
1FJ 358 196-501	12V	10V - 30V	3.8A	-40°C ... +60°C	IP68 IP69K
	24V		2.0A		
1FJ 358 196-511	12V		6.0A		
	24V		3.3A		
1FJ 358 196-521	12V		7.8A		
	24V		4.1A		
1GJ 358 197-501	12V		5.7-8.0A		
	24V		2.8-3.9A		
1GJ 358 197-511	12V		8.9-12.5A		
	24V		4.2-6.1A		
1GJ 358 197-521	12V		10.1-14.9A		
	24V		4.9-7.8A		
1GJ 358 197-531	12V		11.8-19.2A		
	24V		5.6-10.1A		

Der Betrieb der Leuchte mit Wechselspannung oder getakteter Gleichspannung ist nicht zulässig!

	Nominal voltage	Range of voltage	Input values	Admissible ambient temperature	Class of protection
1FJ 358 196-501	12V	10V - 30V	3.8A	-40°C ... +60°C	IP68 IP69K
	24V		2.0A		
1FJ 358 196-511	12V		6.0A		
	24V		3.3A		
1FJ 358 196-521	12V		7.8A		
	24V		4.1A		
1GJ 358 197-501	12V		5.7-8.0A		
	24V		2.8-3.9A		
1GJ 358 197-511	12V		8.9-12.5A		
	24V		4.2-6.1A		
1GJ 358 197-521	12V		10.1-14.9A		
	24V		4.9-7.8A		
1GJ 358 197-531	12V	11.8-19.2A			
	24V	5.6-10.1A			

Operation of the light using alternating voltage or clocked direct voltage is not permitted!

	Tension nominale	Plage de tension	Valeurs d'entrée	Température ambiante admissible	Classe de protection
1FJ 358 196-501	12V	10V - 30V	3.8A	-40°C ... +60°C	IP68 IP69K
	24V		2.0A		
1FJ 358 196-511	12V		6.0A		
	24V		3.3A		
1FJ 358 196-521	12V		7.8A		
	24V		4.1A		
1GJ 358 197-501	12V		5.7-8.0A		
	24V		2.8-3.9A		
1GJ 358 197-511	12V		8.9-12.5A		
	24V		4.2-6.1A		
1GJ 358 197-521	12V		10.1-14.9A		
	24V		4.9-7.8A		
1GJ 358 197-531	12V		11.8-19.2A		
	24V		5.6-10.1A		

Le fonctionnement du feu avec une tension alternative ou une tension continue cadencée n'est pas admis!

	Märkspänning	Spänningssområde	Ingångsvärden	Tillåten omgivningstemperatur	Skyddsklass
1FJ 358 196-501	12V	10V - 30V	3.8A	-40°C ... +60°C	IP68 IP69K
	24V		2.0A		
1FJ 358 196-511	12V		6.0A		
	24V		3.3A		
1FJ 358 196-521	12V		7.8A		
	24V		4.1A		
1GJ 358 197-501	12V		5.7-8.0A		
	24V		2.8-3.9A		
1GJ 358 197-511	12V		8.9-12.5A		
	24V		4.2-6.1A		
1GJ 358 197-521	12V		10.1-14.9A		
	24V		4.9-7.8A		
1GJ 358 197-531	12V	11.8-19.2A			
	24V	5.6-10.1A			

Lampan får inte användas med växelspanning eller taktad likspanning!

	Nominale spanning	Spanningsbereik	Ingangswaarden	Toegestane omgevingstemperatuur	Beschermklasse
1FJ 358 196-501	12V	10V - 30V	3.8A	-40°C ... +60°C	IP68 IP69K
	24V		2.0A		
1FJ 358 196-511	12V		6.0A		
	24V		3.3A		
1FJ 358 196-521	12V		7.8A		
	24V		4.1A		
1GJ 358 197-501	12V		5.7-8.0A		
	24V		2.8-3.9A		
1GJ 358 197-511	12V		8.9-12.5A		
	24V		4.2-6.1A		
1GJ 358 197-521	12V		10.1-14.9A		
	24V		4.9-7.8A		
1GJ 358 197-531	12V	11.8-19.2A			
	24V	5.6-10.1A			

Het gebruik van de lamp met wisselspanning of getacte gelijkspanning is niet toegestaan!

ES DATOS TÉCNICOS

	Tensión nominal	Margen de tensión	Valores de entrada	Temperatura ambiente admisible	Clase de protección
1FJ 358 196-501	12V	10V - 30V	3.8A	-40°C ... +60°C	IP68 IP69K
	24V		2.0A		
1FJ 358 196-511	12V		6.0A		
	24V		3.3A		
1FJ 358 196-521	12V		7.8A		
	24V		4.1A		
1GJ 358 197-501	12V		5.7-8.0A		
	24V		2.8-3.9A		
1GJ 358 197-511	12V		8.9-12.5A		
	24V		4.2-6.1A		
1GJ 358 197-521	12V		10.1-14.9A		
	24V		4.9-7.8A		
1GJ 358 197-531	12V		11.8-19.2A		
	24V		5.6-10.1A		

¡No es admisible el funcionamiento de las luces con corriente alterna o corriente continua sincronizada!

IT DATI TECNICI

	Tensione nominale	Intervallo di tensione	Valori di ingresso	Temperatura ambiente ammessa	Categoria di protezione
1FJ 358 196-501	12V	10V - 30V	3.8A	-40°C ... +60°C	IP68 IP69K
	24V		2.0A		
1FJ 358 196-511	12V		6.0A		
	24V		3.3A		
1FJ 358 196-521	12V		7.8A		
	24V		4.1A		
1GJ 358 197-501	12V		5.7-8.0A		
	24V		2.8-3.9A		
1GJ 358 197-511	12V		8.9-12.5A		
	24V		4.2-6.1A		
1GJ 358 197-521	12V		10.1-14.9A		
	24V		4.9-7.8A		
1GJ 358 197-531	12V		11.8-19.2A		
	24V		5.6-10.1A		

Non è consentito attivare i fanali con tensione alternata o tensione continua ciclica!

FI **TEKNISET TIEDOT**

	Nimellis- jännite	Jännitealue	Tuloarvot	Sallittu ympäristölämpötila	Kotelointiluokka
1FJ 358 196-501	12V	10V - 30V	3.8A	-40°C ... +60°C	IP68 IP69K
	24V		2.0A		
1FJ 358 196-511	12V		6.0A		
	24V		3.3A		
1FJ 358 196-521	12V		7.8A		
	24V		4.1A		
1GJ 358 197-501	12V		5.7-8.0A		
	24V		2.8-3.9A		
1GJ 358 197-511	12V		8.9-12.5A		
	24V		4.2-6.1A		
1GJ 358 197-521	12V		10.1-14.9A		
	24V		4.9-7.8A		
1GJ 358 197-531	12V		11.8-19.2A		
	24V		5.6-10.1A		

Valoa ei saa käyttää vaihtojännitteellä eikä tahdistetulla tasajännitteellä!

PT DADOS TÉCNICOS

	Tensão nominal	Gama de tensão	Valores de entrada	Temperatura ambiente admissível	Classe de proteção
1FJ 358 196-501	12V	10V - 30V	3.8A	-40°C ... +60°C	IP68 IP69K
	24V		2.0A		
1FJ 358 196-511	12V		6.0A		
	24V		3.3A		
1FJ 358 196-521	12V		7.8A		
	24V		4.1A		
1GJ 358 197-501	12V		5.7-8.0A		
	24V		2.8-3.9A		
1GJ 358 197-511	12V		8.9-12.5A		
	24V		4.2-6.1A		
1GJ 358 197-521	12V		10.1-14.9A		
	24V		4.9-7.8A		
1GJ 358 197-531	12V		11.8-19.2A		
	24V		5.6-10.1A		

Não é permitido o funcionamento da lâmpada com tensão alternada ou com tensão contínua por impulso!

	Napięcie znamionowe	Zakres napięcia	Wartości wejściowe	Dopuszczalna temperatura otoczenia	Stopień ochrony
1FJ 358 196-501	12V	10V - 30V	3.8A	-40°C ... +60°C	IP68 IP69K
	24V		2.0A		
1FJ 358 196-511	12V		6.0A		
	24V		3.3A		
1FJ 358 196-521	12V		7.8A		
	24V		4.1A		
1GJ 358 197-501	12V		5.7-8.0A		
	24V		2.8-3.9A		
1GJ 358 197-511	12V		8.9-12.5A		
	24V		4.2-6.1A		
1GJ 358 197-521	12V		10.1-14.9A		
	24V		4.9-7.8A		
1GJ 358 197-531	12V	11.8-19.2A			
	24V	5.6-10.1A			

Lampy nie wolno zasilać ze źródła napięcia przemiennego ani napięcia stałego impulsowego!

	Nominal gerilim	Gerilim aralığı	Giriş değerleri	İzin verilen ortam sıcaklığı	Koruma sınıfı
1FJ 358 196-501	12V	10V - 30V	3.8A	-40°C ... +60°C	IP68 IP69K
	24V		2.0A		
1FJ 358 196-511	12V		6.0A		
	24V		3.3A		
1FJ 358 196-521	12V		7.8A		
	24V		4.1A		
1GJ 358 197-501	12V		5.7-8.0A		
	24V		2.8-3.9A		
1GJ 358 197-511	12V		8.9-12.5A		
	24V		4.2-6.1A		
1GJ 358 197-521	12V		10.1-14.9A		
	24V		4.9-7.8A		
1GJ 358 197-531	12V		11.8-19.2A		
	24V		5.6-10.1A		

Lambanın alternatif gerilimle veya darbeli DC gerilimle çalıştırılmasına izin verilmez!

فئة الحماية	درجة حرارة الجو المسموح بها	قيم الدخل	مدى الجهد	الجهد الاسمي	
IP68 IP69K	-40°C ... +60°C	3.8A	10V - 30V	12V	1FJ 358 196-501
		2.0A		24V	
		6.0A		12V	1FJ 358 196-511
		3.3A		24V	
		7.8A		12V	1FJ 358 196-521
		4.1A		24V	
		5.7-8.0A		12V	1GJ 358 197-501
		2.8-3.9A		24V	
		8.9-12.5A		12V	1GJ 358 197-511
		4.2-6.1A		24V	
		10.1-14.9A		12V	1GJ 358 197-521
		4.9-7.8A		24V	
		11.8-19.2A		12V	1GJ 358 197-531
		5.6-10.1A		24V	

غير مسموح بتشغيل اللمبات بواسطة تيار متردد أو تيار متردد عن طريق مهايئ للجهد!

DE Beleuchtungsanlage auf einwandfreie Funktion hin prüfen

EN Check that the lighting system is working perfectly

FR Contrôler le bon fonctionnement de l'installation d'éclairage

SV Kontrollera att ljussystemet fungerar felfritt

NL Controleer of de verlichting goed functioneert

ES Comprobar que el sistema de iluminación funciona impecablemente

IT Controllare la perfetta funzionalità dell'impianto di illuminazione

FI Tarkasta valaistusjärjestelmän toiminta

PT Verifique que o sistema de iluminação está a funcionar bem

PL Sprawdź, czy system oświetlenia działa bez zarzutu

TR Aydınlatma sisteminin mükemmel çalışıp çalışmadığını kontrol edin

تأكد أن مجموعة الأضواء تعمل بشكل صحيح **AR**

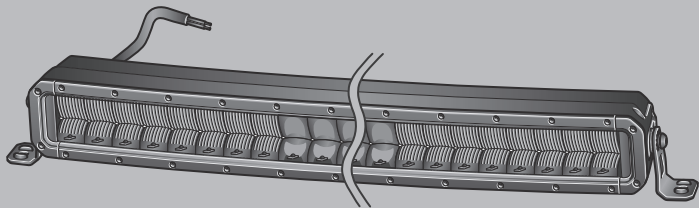

HELLA GmbH & Co. KGaA

Rixbecker Straße 75

59552 Lippstadt /Germany

www.hella.com

© HELLA GmbH & Co. KGaA, Lippstadt

460 881-97 /08.22