

# böck

## PRODUKTKATALOG 2024

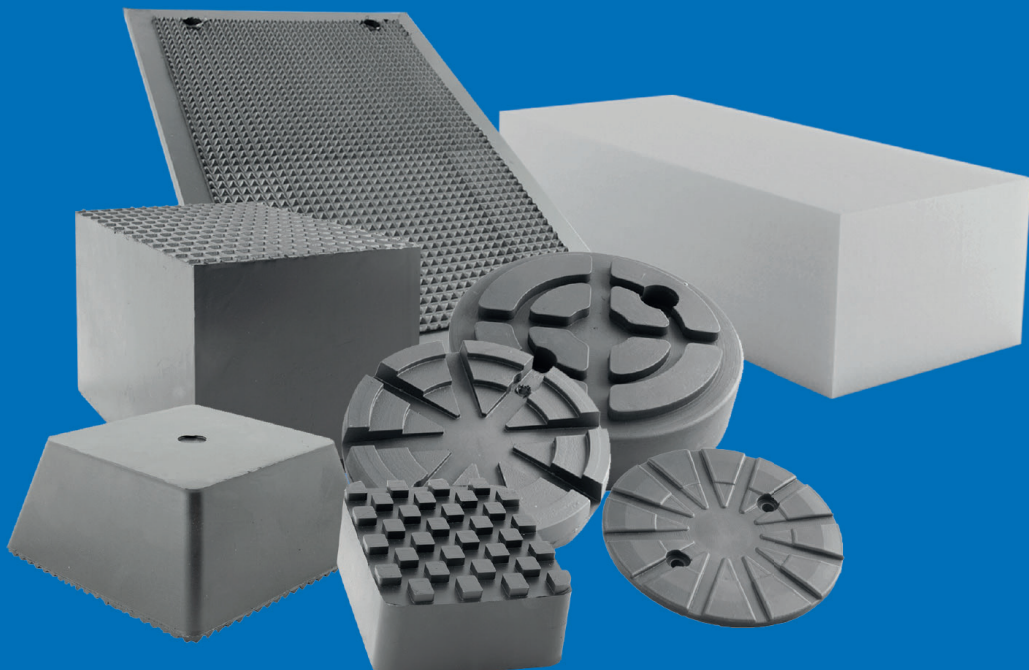

GUMMITASSAR | GUMMIBLOCK | LYFTBLOCK |  
GUMMIPLATTOR | SPECIALUTRUSTNING  
UNIVERSALRAMPER | Fyllnadsplattor  
FÖR NÄSTAN ALLA BILLYFTAR

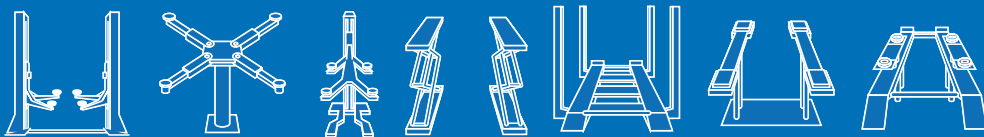

POWERED  
by **KGK**



GUMMITASSAR  
SIDA 3



GUMMIBLOCK  
SIDA 19



LYFTBLOCK  
SIDA 25



GUMMIPLATTOR  
SIDA 27

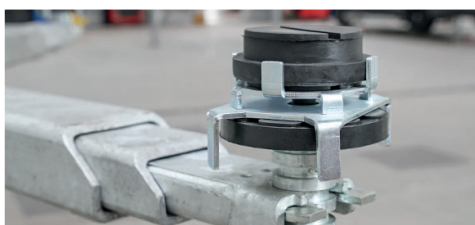

SPECIALUTRUSTNING  
SIDA 30



UNIVERSALRAMPER  
SIDA 31



FYLLNADSPLATTOR  
SIDA 32

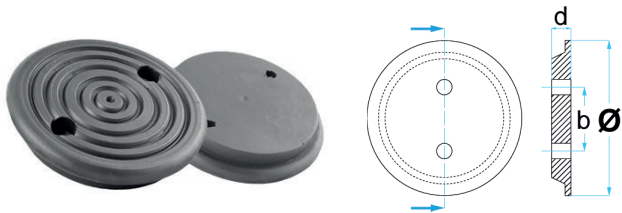

BO-015

Ø	a	b	d	e
115 mm	-	73 mm	20 mm	-

 0,25 kg

passar till:  
J.A.B. BECKER

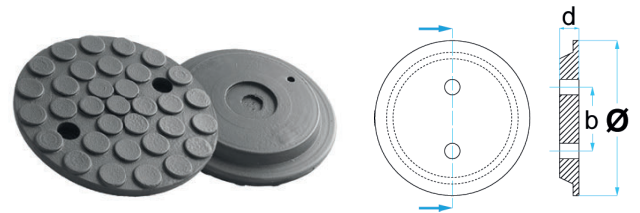

BO-024481

Ø	a	b	d	e
120 mm	-	75 mm	21 mm	-

 0,15 kg

passar till:  
J.A.B. BECKER

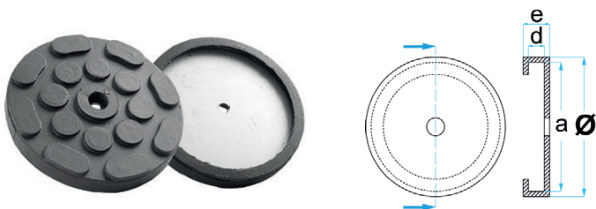

BO-169100MET

Ø	a	b	d	e
120 mm	110 mm	-	4 mm	16 mm

 0,29 kg med stålplatta

passar till:  
J.A.B. BECKER / ATH-HEINL / HOFMANN /  
JOHN BEAN / HERRMANN / AUTOP-STENHOJ /  
FINKBEINER / KIRSTEN / WEBER

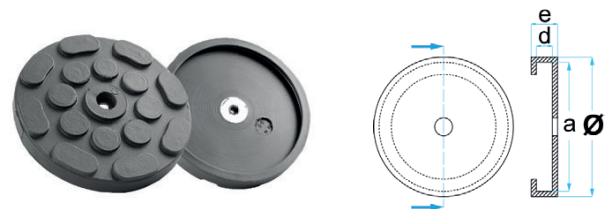

BO-169100

Ø	a	b	d	e
120 mm	110 mm	-	4 mm	16 mm

 0,15 kg

passar till:  
J.A.B. BECKER / ATH-HEINL / HOFMANN /  
JOHN BEAN / HERRMANN / AUTOP-STENHOJ /  
FINKBEINER / KIRSTEN / WEBER

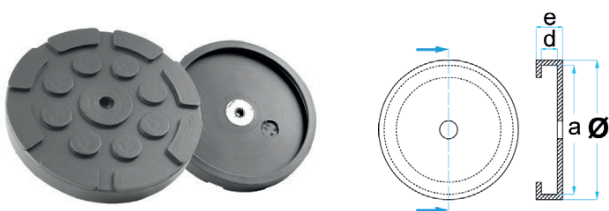

BO-169130

Ø	a	b	d	e
130 mm	122 mm	-	5 mm	17 mm

 0,20 kg

passar till:  
HERRMANN

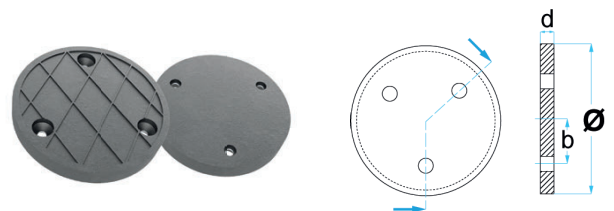

BO-GT-BTHZ12015

Ø	a	b	d	e
120 mm	-	45 mm	15 mm	-

 0,35 kg med stålplatta

passar till:  
J.A.B. BECKER / ZIPPO



BO-335022

Ø	a	b	d	e
140 mm	132 mm	-	4 mm	17 mm

0,20 kg

passar till:  
HOFMANN



BO-335160-GS5.0

Ø	a	b	d	e
160 mm	148 mm	-	6 mm	24 mm

0,38 kg

passar till:  
HOFMANN



BO-336000

a	b	d	l	w
154 mm	82 mm	10 mm	162 mm	92 mm

0,24 kg

passar till:  
HOFMANN / ROMEICO / HYMO



BO-01103031

Ø	a	b	d	e
125 mm	120 mm	90 mm	24 mm	-

0,30 kg med stålplatta

passar till:  
NUSSBAUM / ATT / AMI / AMMCO / FORCE /  
WHEELTRONIC / PHOENIX / SNAP-ON

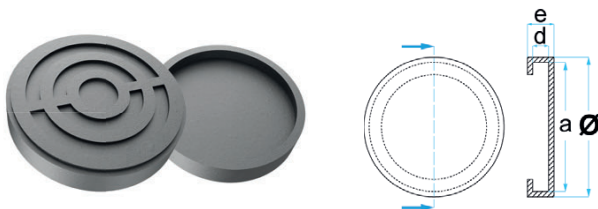

BO-SOVW-NUS

Ø	a	b	d	e
132 mm	121 mm	-	8 mm	24 mm

0,23 kg

passar till:  
NUSSBAUM

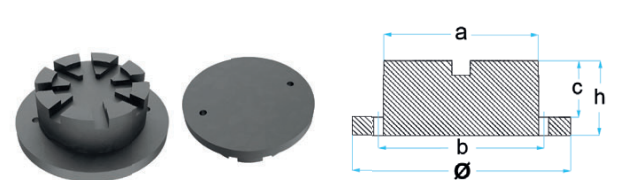

BO-GPROD-NUS

Ø	a	b	c	h
120 mm	85 mm	90 mm	31 mm	41 mm

0,35 kg

passar till:  
NUSSBAUM

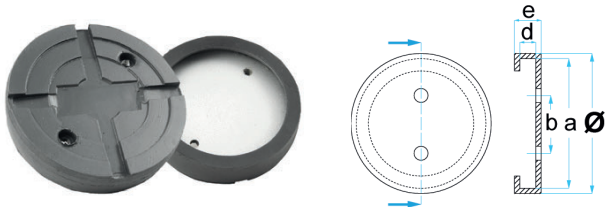

## BO-GK125120-OL

Ø	a	b	d	e
127 mm	120 mm	83 mm	9 mm	28 mm

 0,35 kg med stålplatta

passar till:  
SLIFT / IME

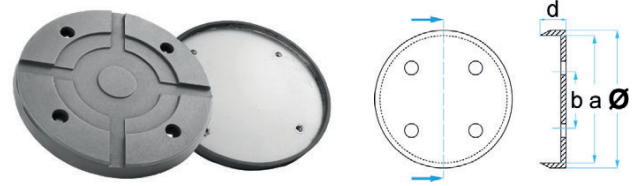

## BO-GK15516

Ø	a	b	d	e
155 mm	153 mm	85 mm	16 mm	-

 0,38 kg med stålplatta

passar till:  
SLIFT / IME



## BO-GK12212

Ø	a	b	d	e
122 mm	116 mm	80 mm	12 mm	-

 0,15 kg med stålplatta

passar till:  
SLIFT / IME

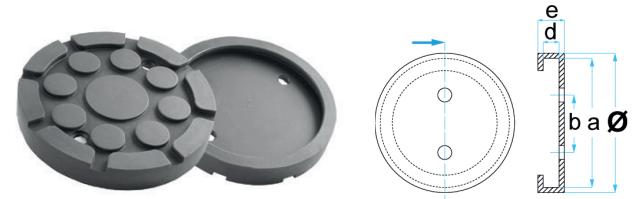

## BO-36001.04.04.

Ø	a	b	d	e
120 mm	112 mm	83 mm	5 mm	18 mm

 0,15 kg

passar till:  
MAHA / SLIFT / AUTOMASTER

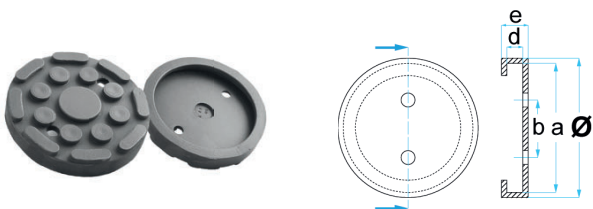

## BO-115172024

Ø	a	b	d	e
100 mm	90 mm	63 mm	5 mm	17,5 mm

 0,10 kg

passar till:  
MAHA / SLIFT



## BO-17202301MET

Ø	a	b	d	e
120 mm	113 mm	83 mm	8 mm	22 mm

 0,26 kg med stålplatta

passar till:  
MAHA

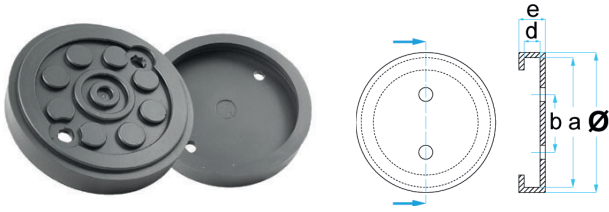

BO-17202301

Ø	a	b	d	e
120 mm	113 mm	83 mm	8 mm	22 mm

0,15 kg

passar till:  
MAHA

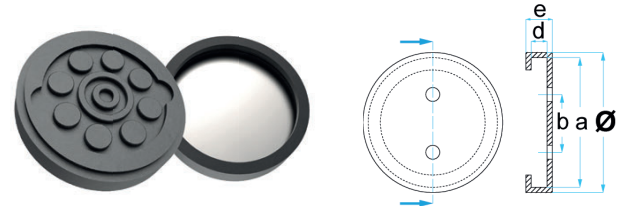

BO-17202301EMB

Ø	a	b	d	e
120 mm	110 mm	-	8 mm	22 mm

0,15 kg utan skruvhål, dras över

passar till:  
MAHA

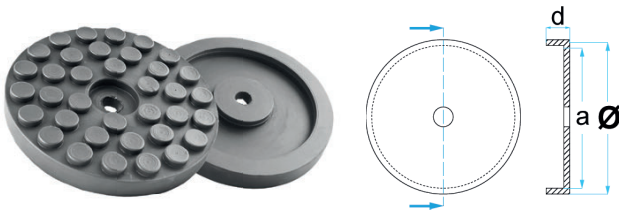

BO-121KP6Z215

Ø	a	b	d	e
144 mm	117 mm	-	20 mm	-

0,30 kg

passar till:  
RAVAGLIOLI



BO-047021040

Ø	a	b	d	e
145 mm	-	45 mm	26 mm	-

0,30 kg

passar till:  
RAVAGLIOLI / OMER



BO-04640577

Ø	a	b	d	e
120 mm	-	36 mm	27 mm	-

0,20 kg

passar till:  
RAVAGLIOLI / SPACE / OMER



BO-046405772MET

Ø	a	b	d	e
123 mm	110 mm	-	10 mm	25 mm

0,30 kg med stålplatta

passar till:  
RAVAGLIOLI / WERTHER / SPACE / ORLANDINI  
/ OMER



BO-046405772

Ø	a	b	d	e
123 mm	110 mm	-	10 mm	25 mm

0,15 kg

passar till:  
RAVAGLIOLI / WERTHER / SPACE / ORLANDINI  
/ OMER

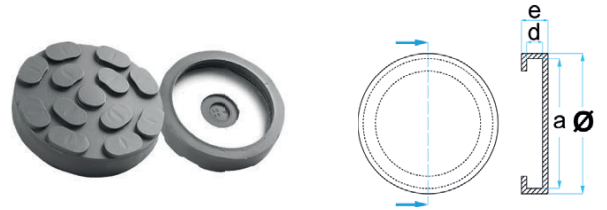

BO-047021850MET

Ø	a	b	d	e
100 mm	87 mm	-	9 mm	22 mm

0,17 kg med stålplatta

passar till:  
RAVAGLIOLI / SIRIO / SPACE / SUPREME /  
MOLNAR

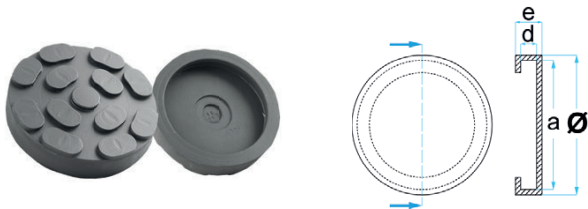

BO-047021850

Ø	a	b	d	e
100 mm	87 mm	-	9 mm	22 mm

0,10 kg

passar till:  
RAVAGLIOLI / SIRIO / SPACE / SUPREME /  
MOLNAR

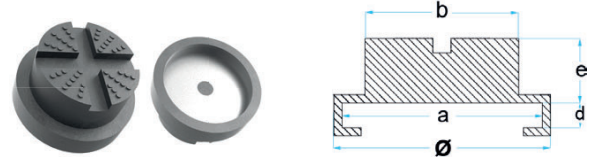

BO-GT-359.B8X

Ø	a	b	d	e
100 mm	87 mm	-	9 mm	38 mm

0,30 kg med stålplatta

passar till:  
RAVAGLIOLI / SIRIO / SPACE / SUPREME /  
MOLNAR



BO-047021041

Ø	a	b	d	e
148 mm	133 mm	-	10 mm	25 mm

0,26 kg

passar till:  
RAVAGLIOLI

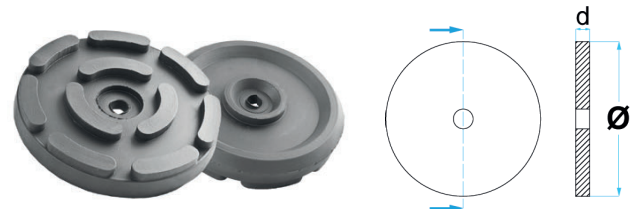

BO-OMCN-140

Ø	a	b	d	e
143 mm	-	-	27 mm	-

0,35 kg

passar till:  
OMCN



BO-OMCN-140-002

Ø	a	b	d	e
140 mm	-	42 mm	29 mm	-

 0,31 kg

passar till:  
OMCN

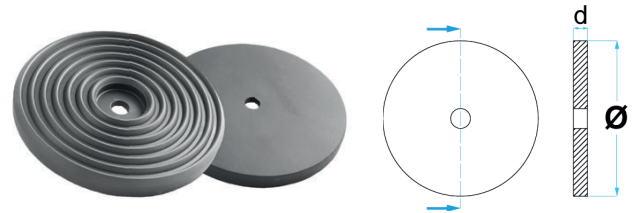

BO-WERTHER002

Ø	a	b	d	e
140 mm	-	-	15 mm	-

 0,25 kg

passar till:  
WERTHER / OMA / BRADBURY / TECALEMIT /  
AUTEC

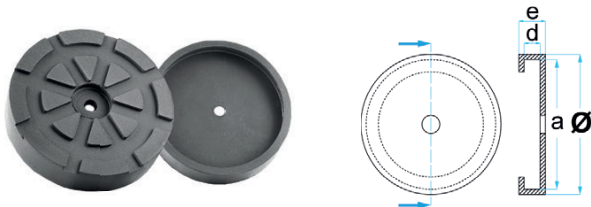

BO-WERTHER00107

Ø	a	b	d	e
122 mm	114 mm	-	10 mm	28 mm

 0,23 kg

passar till:  
WERTHER / OMA / TECALEMIT / ITALGARAGE  
/ FINKBEINER

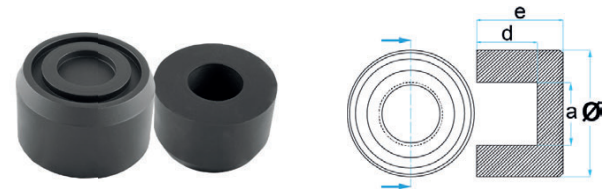

BO-WERTHER00153

Ø	a	b	d	e
85 mm	39 mm	-	29 mm	50 mm

 0,31 kg

passar till:  
WERTHER



BO-15.87.425

Ø	a	b	d	e
127 mm	123 mm	-	8 mm	22 mm

 0,15 kg

passar till:  
CONSUL / ZIPPO / FOG

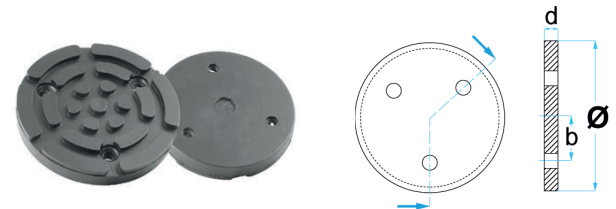

BO-15.87.410

Ø	a	b	d	e
100 mm	-	35 mm	17mm	-

 0,24 kg med stålplatta

passar till:  
ZIPPO / GRUSE



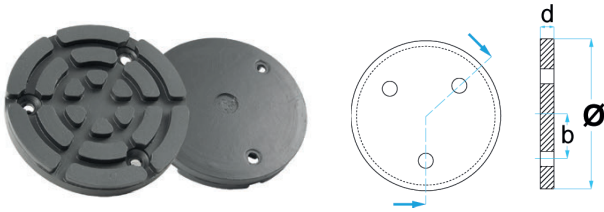

BO-15.87.420

Ø	a	b	d	e
120 mm	-	44 mm	16 mm	-

0,28 kg med stålplatta

passar till:  
ZIPPO

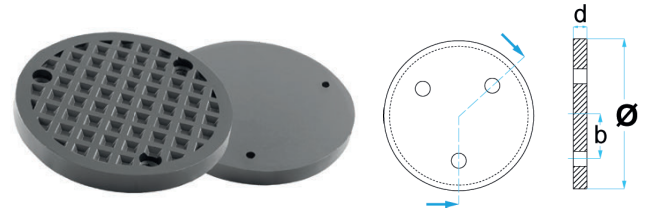

BO-15.87.450

Ø	a	b	d	e
149 mm	-	60 mm	15 mm	-

0,75 kg med stålplatta

passar till:  
ZIPPO



BO-15.87.453

Ø	a	b	d	e
153 mm	-	60 mm	32 mm	-

0,75 kg med stålplatta

passar till:  
ZIPPO



BO-02-CONSUL

Ø	a	b	d	e
138 mm	-	-	18 mm	-

0,75 kg med stålplatta

passar till:  
CONSUL



BO-02-CONSUL-CA

Ø	a	b	d	e
135 mm	35 mm	40 mm	-	-

1,50 kg roterande platta med utbyttbar lyfttass

passar till:  
CONSUL / ZIPPO / BEISSBARTH

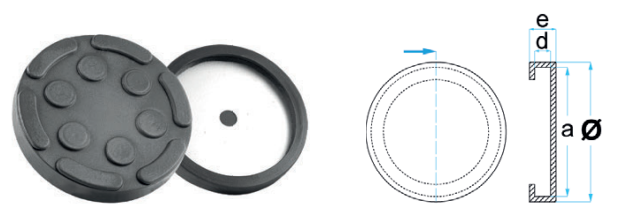

BO-02-CONSUL-GT

Ø	a	b	d	e
135 mm	126 mm	-	8 mm	10 mm

0,30 kg med stålplatta

passar till:  
CONSUL / ZIPPO / BEISSBARTH / HERRMANN



BO-664202

Ø	a	b	d	e
121 mm	-	65 mm	9 mm	-

 0,20 kg med stålplatta

passar till:  
AUTOP-STENHOJ / FOG / CAR-O-LINER

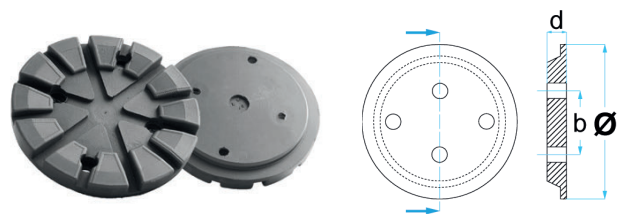

BO-664000

Ø	a	b	d	e
122 mm	-	65 / 88 mm	18 mm	-

 0,18 kg

passar till:  
AUTOP-STENHOJ / NUSSBAUM / FOG / CAR-O-LINER



BO-664160

Ø	a	b	d	e
158 mm	-	47 mm	11 mm	-

 0,40 kg med stålplatta

passar till:  
AUTOP-STENHOJ

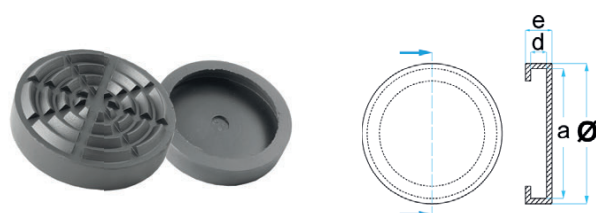

BO-SK2030-105

Ø	a	b	d	e
109 mm	100 mm	-	10 mm	26 mm

 0,15 kg

passar till:  
KONI / BRADBURY / HERKULES / TECALEMIT / MAJORLIFT



BO-SK2030-124

Ø	a	b	d	e
124 mm	118 mm	-	5 mm	17 mm

 0,13 kg

passar till:  
KONI



BO-SK2030-160

Ø	a	b	d	e
160 mm	153 mm	-	10 mm	28 mm

 0,33 kg

passar till:  
KONI / ROMEICO / CAR-O-LINER / HH-INTERTECH / BEISSBARTH / FOG / MONDOLFO FERRO



## BO-ROMEICO124

Ø	a	b	d	e
124 mm	116 mm	-	10 mm	22 mm

0,15 kg

passar till:  
ROMEICO / HH-INTERTECH / CORGHI /  
GRAZIA



## BO-ROTARY

Ø	a	b	d	e
123 mm	112 mm	-	8 mm	20 mm

0,17 kg

passar till:  
ROTARY / HERRMANN / ATH-HEINL

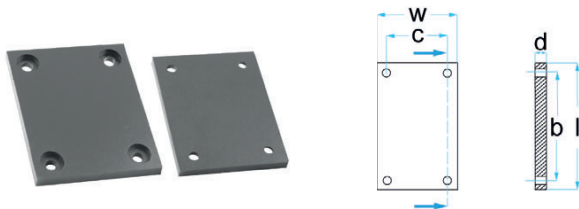

## BO-ROTARY-FJRP

b	c	d	l	w
80 mm	56 mm	8 mm	104 mm	82 mm

0,12 kg

passar till:  
ROTARY



## BO-ROTARY-PU735

a	b	d	l	w
116 mm	80 mm	9 mm	128 mm	89 mm

0,12 kg

passar till:  
ROTARY



## BO-ZAV-41-113

Ø	a	b	d	e
128 mm	112 mm	-	8 mm	22 mm

0,20 kg

passar till:  
EUROLIFT / ORLANDINI



## BO-IST0720300

Ø	a	b	d	e
155 mm	147 mm	-	6 mm	24 mm

0,27 kg

passar till:  
ISTOBAL / VELYEN

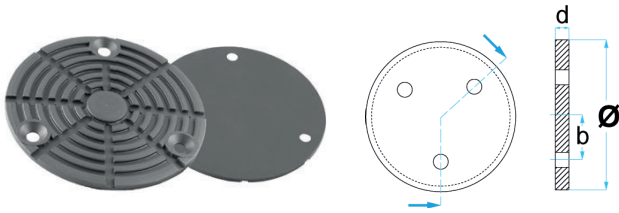

BO-IST1304800

Ø	a	b	d	e
145 mm	-	60 mm	5 mm	-

0,10 kg

passar till:  
ISTOBAL / VELYEN / SOURIAU

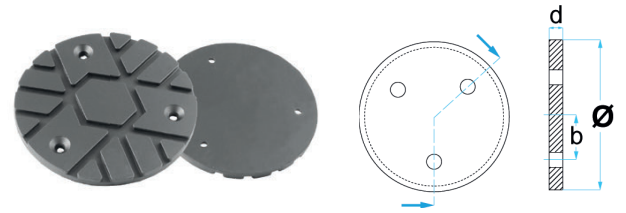

BO-VEL001

Ø	a	b	d	e
121 mm	-	46 mm	7 mm	-

0,10 kg

passar till:  
ISTOBAL / VELYEN



BO-LAUNCH120

Ø	a	b	d	e
120 mm	108 mm	69 mm	32 mm	-

0,30 kg

passar till:  
LAUNCH / EVER ETERNAL / TWIN BUSCH / RP  
TOOLS / ATH-HEINL / LINCOS / Många asiatiska  
billyftar



BO-COR001483

Ø	a	b	d	e
126 mm	120 mm	-	10 mm	24 mm

0,21 kg

passar till:  
CORGHI / HPA - FAIP / MONDOLFO FERRO /  
ORLANDINI / SICE



BO-AGM139

Ø	a	b	d	e
139 mm	130 mm	-	8 mm	28 mm

0,30 kg

passar till:  
AGM / CORGHI / FOG / SICE / HPA - FAIP /  
AUTEC / MOLNAR



BO-CASCOS001

Ø	a	b	d	e
138 mm	130 mm	-	8 mm	25 mm

0,26 kg

passar till:  
CASCOS / VILVER



BO-BRADBURY001

Ø	a	b	d	e
158 mm	148 mm	-	11 mm	27 mm

0,37 kg

passar till:  
BRADBURY / HH-INTERTECH

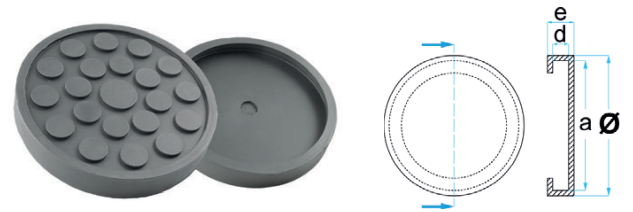

BO-BRADBURY002

Ø	a	b	d	e
150 mm	142 mm	-	7 mm	22 mm

0,21 kg

passar till:  
BRADBURY

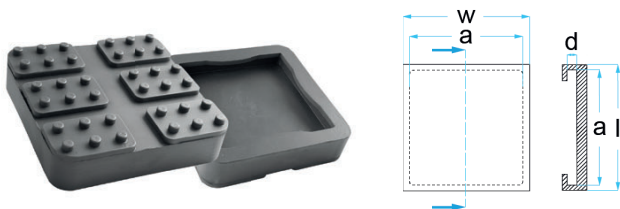

BO-RANGER001

a	b	d	l	w
126 mm	-	13 mm	143 mm	143 mm

0,50 kg

passar till:  
BENDPAK / RANGER / DANNMAR

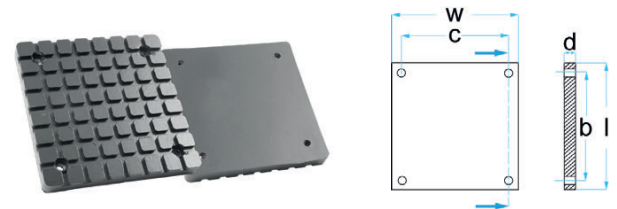

BO-BENDPAK002

b	c	d	l	w
88 mm	88 mm	12 mm	119 mm	119 mm

0,20 kg

passar till:  
BENDPAK / DAYTONA



BO-BENDPAK003

Ø	a	b	d	e
127 mm	111 mm	-	11 mm	26 mm

0,26 kg

passar till:  
BENDPAK



BO-BENDPAK004

a	b	d	l	w
126 mm	-	13 mm	143 mm	143 mm

0,50 kg

passar till:  
BENDPAK / RANGER / DANNMAR



## BO-LAYCOCK001

a	b	d	l	w
140 mm	70 mm	28 mm	150 mm	80 mm

0,27 kg

passar till:  
LAYCOCK / KISMET

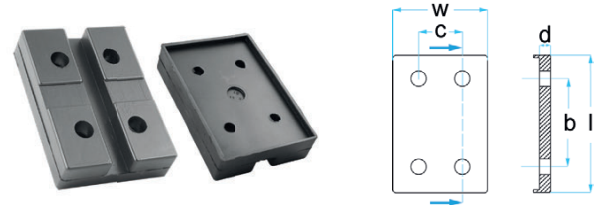

## BO-SILENT001

b	c	d	l	w
60 mm	40 mm	20 mm	118 mm	83 mm

0,27 kg

passar till:  
BRADBURY / DUNLOP / SILENT / Många  
asiatiska billyftar

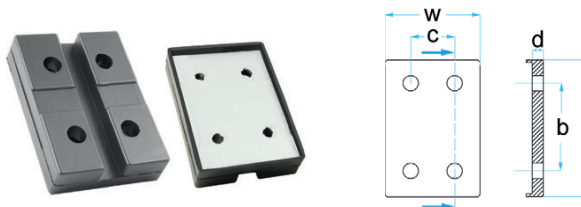

## BO-SILENT001MET

b	c	d	l	w
60 mm	40 mm	20 mm	118 mm	83 mm

0,35 kg med stålplatta

passar till:  
BRADBURY / DUNLOP / SILENT / Många  
asiatiska billyftar



## BO-SUM001

Ø	a	b	d	e
140 mm	134 mm	118 mm	20 mm	88 mm

0,29 kg

passar till:  
SUMMIT

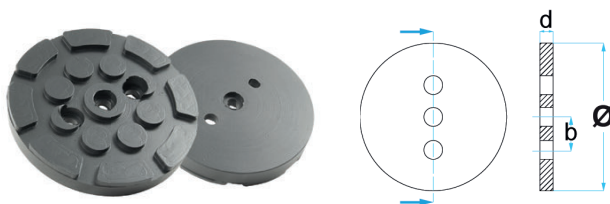

## BO-HPOW001

Ø	a	b	d	e
120 mm	-	25 mm	17 mm	-

0,21 kg

passar till:  
POWERREX / HESHBON / AUTOP-STENHOJ /  
Många asiatiska billyftar

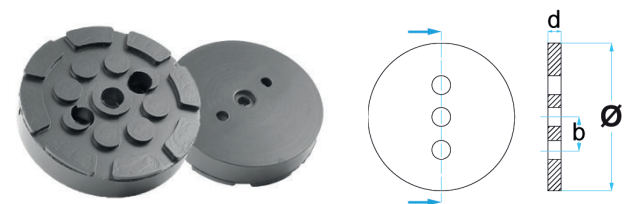

## BO-HPOW002

Ø	a	b	d	e
120 mm	-	25 mm	25 mm	-

0,32 kg

passar till:  
POWERREX / HESHBON / ROTARY / JIG /  
QUALITY LIFTS / Många asiatiska billyftar

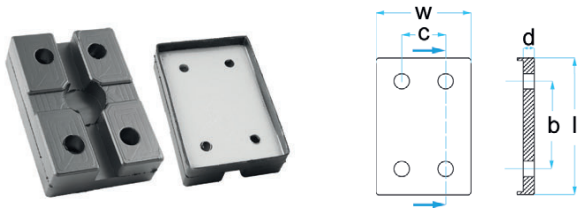

## BO-BISHAMON001

b	c	d	l	w
74 mm	40 mm	20 mm	116 mm	80 mm

0,28 kg med stålplatta

passar till:  
BISHAMON / CHIANG LURN / CARLEO

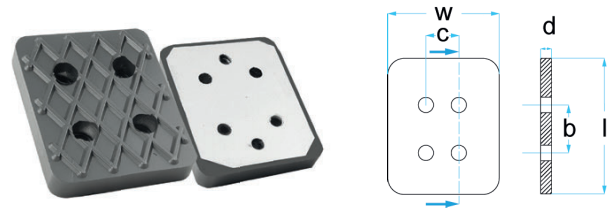

## BO-BISHAMON002

b	c	d	l	w
45 mm	40 mm	16 mm	112 mm	92 mm

0,31 kg med stålplatta

passar till:  
BISHAMON / BENWIL

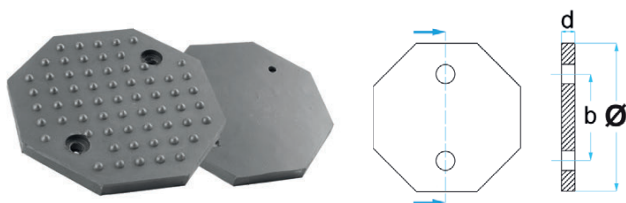

## BO-GTCN001

Ø	a	b	d	e
125 mm	-	90 mm	10 mm	-

0,17 kg

passar till:  
AUTOMOTECH / EVER ETERNAL / TWIN BUSCH  
/ HANMECSON / FORWARD / Många asiatiska  
billyftar

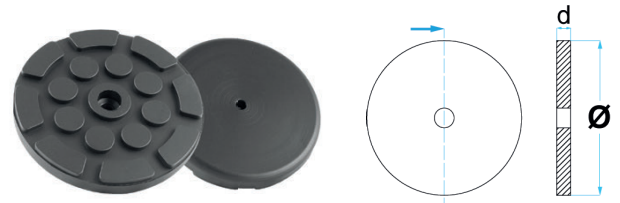

## BO-GTCN002

Ø	a	b	d	e
120 mm	-	-	17 mm	-

0,21 kg

passar till:  
AUTOP-STENHOJ / ATH-HEINL/ HESHBON /  
TWIN BUSCH / LINCOS / PROVAC / KRÖMER /  
AUTOMASTER / Många asiatiska billyftar



## BO-GTCN002-RNG

Ø	a	b	d	e
132 mm	-	119 mm	14 mm	9 mm

0,21 kg

passar till:  
Många asiatiska billyftar

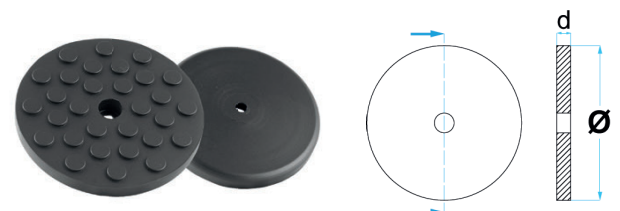

## BO-GTCN003

Ø	a	b	d	e
120 mm	-	-	15 mm	-

0,21 kg

passar till:  
FOG / DUNLOP / Många asiatiska billyftar

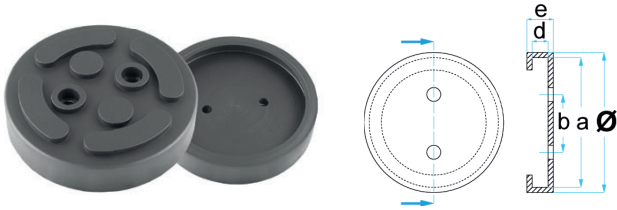

BO-GTCN004

Ø	a	b	d	e
140 mm	125 mm	50 mm	10 mm	32 mm

0,40 kg

passar till:  
NORDIC LIFT / TWIN BUSCH / Många asiatiska billyftar

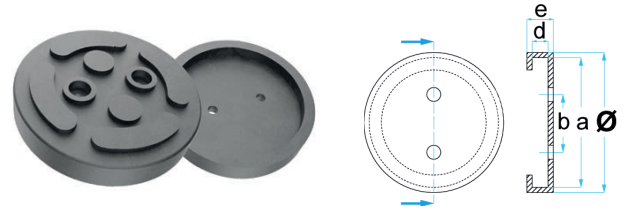

BO-GTCN009

Ø	a	b	d	e
140 mm	120 mm	50 mm	10 mm	32 mm

0,40 kg

passar till:  
EVER ETERNAL / NORDIC LIFT / TWIN BUSCH / Många asiatiska billyftar

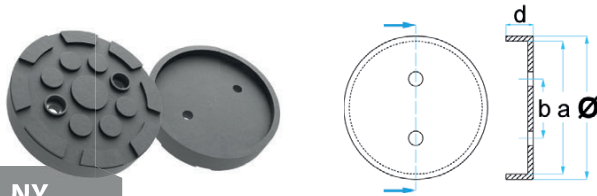

NY

BO-GTCN010

Ø	a	b	d	e
120 mm	108 mm	60 mm	23 mm	-

0,22 kg

passar till:  
WEBER / Många asiatiska billyftar

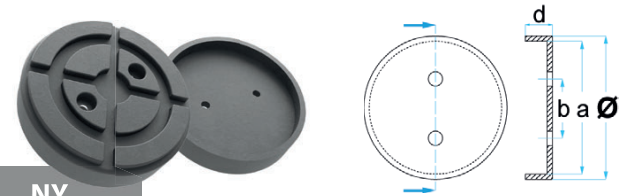

NY

BO-GTCN011

Ø	a	b	d	e
140 mm	128 mm	56 mm	34 mm	-

0,43 kg

passar till:  
WEBER / Många asiatiska billyftar

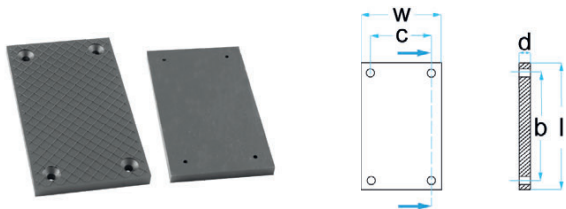

BO-GTCN005

b	c	d	l	w
104 mm	50 mm	9 mm	128 mm	74 mm

0,21 kg

passar till:  
EVER ETERNAL / LAUNCH / TWIN BUSCH / Många asiatiska billyftar

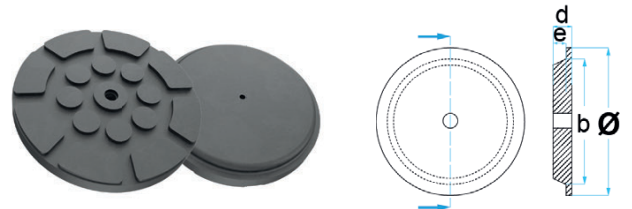

BO-GTCN007-RNG

Ø	a	b	d	e
160 mm	-	150 mm	25,5 mm	9 mm

0,60 kg

passar till:  
Många asiatiska billyftar





BO-GTCN008

Ø	a	b	d	e
140 mm	-	-	21 mm	-

0,35 kg

passar till:  
TWIN BUSCH / ATH-HEINL / Många asiatiska  
billyftar



BO-NORDLIFT1720

Ø	a	b	d	e
127 mm	115 mm	-	7 mm	23 mm

0,17 kg

passar till:  
NORDLIFT



BO-149950

b	c	d	l	w
73 mm	-	18 mm	100 mm	81 mm

0,15 kg

passar till:  
J.A.B. BECKER

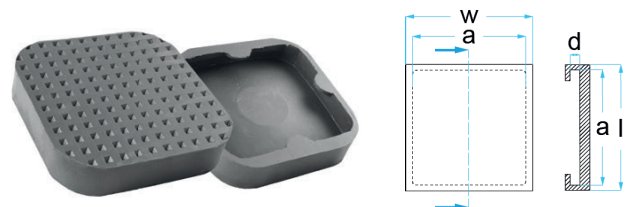

BO-100100

a	b	d	l	w
108 mm	-	23 mm	120 mm	120 mm

0,18 kg

passar till:  
COMPAC



BO-AC-GS1

Ø	a	b	d	e
110 mm	-	-	20 mm	-

0,17 kg

passar till:  
AC HYDRAULIC



BO-AC-GS2

a	b	d	l	w
100 mm	50 mm	10 mm	112 mm	61 mm

0,15 kg

passar till:  
AC HYDRAULIC/ AUTOP-STENHOJ/ MAHA/  
ROTARY



BO-COL001

Ø	a	b	d	e
89 mm	80 mm	-	17 mm	-

 0,10 kg

passar till:  
CAR-O-LINER

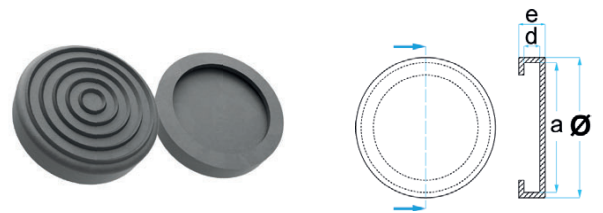

BO-GT-VIGK11527

Ø	a	b	d	e
115 mm	100 mm	-	5 mm	27 mm

 0,25 kg

passar till:  
VILVER



BO-GT-VILN14530

Ø	a	b	d	e
145 mm	130 mm	-	8 mm	31 mm

 0,40 kg

passar till:  
VILVER



## BO-165046

a	b	h
150 × 150 mm	100 × 100 mm	140 mm

2,30 kg

passar till:  
J.A.B. BECKER / AUTOP-STENHOJ / universell användning

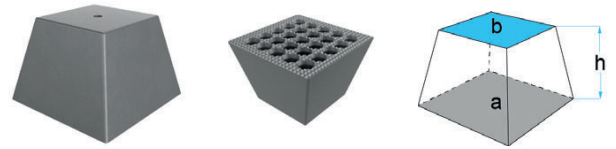

## BO-165042

a	b	h
150 × 150 mm	104 × 104 mm	100 mm

1,75 kg

passar till:  
J.A.B. BECKER / AUTOP-STENHOJ / universell användning



## BO-165030

a	b	h
150 × 150 mm	110 × 110 mm	70 mm

1,40 kg

passar till:  
J.A.B. BECKER / AUTOP-STENHOJ / universell användning



## BO-165036

a	b	h
150 × 150 mm	115 × 115 mm	60 mm

1,20 kg

passar till:  
J.A.B. BECKER / AUTOP-STENHOJ / universell användning

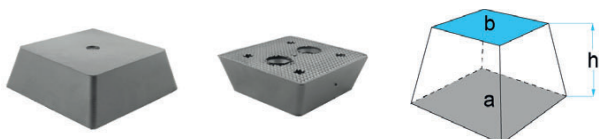

## BO-165031

a	b	h
150 × 150 mm	120 × 120 mm	50 mm

1,10 kg

passar till:  
J.A.B. BECKER / AUTOP-STENHOJ / universell användning



## BO-165034

a	b	h
150 × 150 mm	128 × 128 mm	40 mm

0,90 kg

passar till:  
J.A.B. BECKER / AUTOP-STENHOJ / universell användning



BO-165037

a	b	h
150 × 150 mm	135 × 135 mm	30 mm

 0,72 kg

passar till:  
J.A.B. BECKER / AUTOP-STENHOJ / universell användning



BO-165038

a	b	h
150 × 150 mm	140 × 140 mm	20 mm

 0,47 kg

passar till:  
J.A.B. BECKER / AUTOP-STENHOJ / universell användning

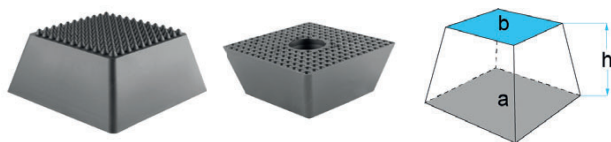

BO-23000251

a	b	h
150 × 150 mm	115 × 115 mm	60 mm

 1,20 kg

passar till:  
MAHA / universell användning



BO-165040

a	b	h
180 × 100 mm	-	100 mm

 2,35 kg

passar till:  
universell användning



BO-165033H

a	b	h
222 × 137 mm	-	85 mm

 2,75 kg med tråkärna

passar till:  
universell användning

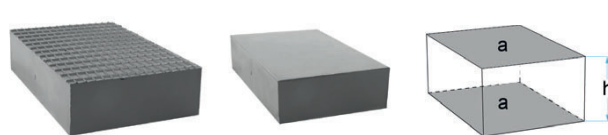

BO-165032

a	b	h
216 × 136 mm	-	50 mm

 1,80 kg

passar till:  
universell användning

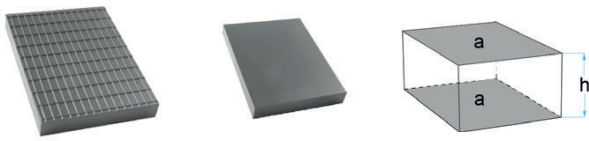

## BO-165035

a	b	h
160 × 120 mm	-	20 mm

0,60 kg

passar till:  
J.A.B. BECKER / AUTOP-STENHOJ / universell användning



## BO-GK128-OL

a	b	h
120 × 120 mm	100 × 100 mm	80 mm

1,10 kg

passar till:  
SLIFT / IME / universell användning



## BO-GK124-OL

a	b	h
120 × 120 mm	102 × 102 mm	40 mm

0,55 kg

passar till:  
SLIFT / IME / universell användning



## BO-MAG12035

a	b	h
120 × 120 mm	110 × 110 mm	35 mm

0,75 kg med magnet

passar till:  
universell användning



## BO-13510030-RU

a	d	h
135 × 135 mm	60 mm	42 mm

0,60 kg Används till saxlyftar för bla. elektriska bilar

passar till:  
Tesla Model 3 och Y / universell användning

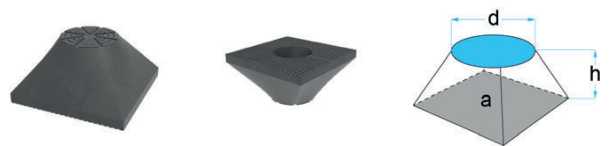

## BO-EV-040.XOP

a	b	h
120 × 120 mm	-	60 mm

0,65 kg Används till saxlyftar för bla. elektriska bilar

passar till:  
Tesla Model Y / universell användning



## BO-EV-120.FIA

a	b	h
140 × 100 mm	100 × 60 mm	120 mm

1,05 kg Används till saxlyftar för bla. elektriska bilar

passar till:  
Fiat 500e / Volvo XC90 / universell användning

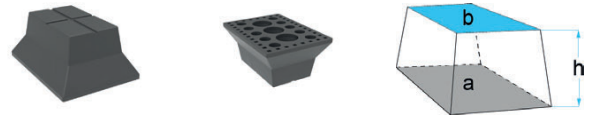

## BO-EV-060.IDT

a	b	h
140 × 100 mm	100 × 60 mm	60 mm

0,60 kg Används till saxlyftar för bla. elektriska bilar

passar till:  
Tesla Model S och X / Universell användning



## BO-13510070

a	b	h
135 × 135 mm	100 × 100 mm	70 mm

1,52 kg

passar till:  
BMW / universell användning

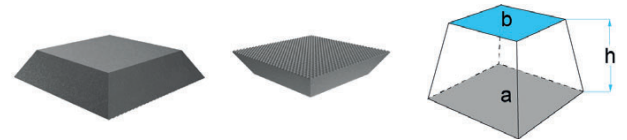

## BO-13510030

a	b	h
135 × 135 mm	100 × 100 mm	30 mm

0,62 kg

passar till:  
BMW / universell användning



## BO-GK169

a	b	h
160 × 120 mm	120 × 83 mm	90 mm

1,48 kg

passar till:  
universell användning



## BO-316930

a	b	h
120 × 100 mm	-	50 mm

0,55 kg

passar till:  
MAHA / HOFMANN / universell användning



## BO-316930-NU

a	b	h
120 × 100 mm	-	50 mm

 0,55 kg

passar till:  
MAHA / universell användning



## BO-38.31.829

a	b	h
200 × 100 mm	180 × 80 mm	40 mm

 0,80 kg

passar till:  
ZIPPO / MAJORLIFT / universell användning



## BO-38.31.830

a	b	h
200 × 100 mm	180 × 80 mm	70 mm

 1,40 kg

passar till:  
ZIPPO / MAJORLIFT / universell användning



## BO-38.31.831

a	b	h
230 × 140 mm	220 × 130 mm	140 mm

 4,25 kg

passar till:  
ZIPPO / MAJORLIFT / universell användning



## BO-38.31.831OLD

a	b	h
230 × 140 mm	215 × 138 mm	135 mm

 4,60 kg med tråkärna

passar till:  
ZIPPO / universell användning





## BO-80100012080

a	b	h
120 × 100 mm	-	80 mm

 0,95 kg

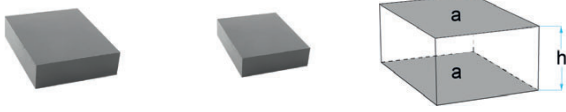
passar till:  
HERKULES

**BO-30100012030**

a	b	h
120 × 100 mm	-	30 mm
 0,45 kg		
passar till: HERKULES		





## BO-PE-900-KGK-2

250 × 150 × 20 mm +/- 5 mm

kg 0,11 kg

passar till:  
universell användning

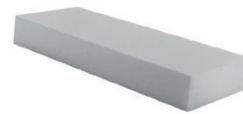

## BO-PE-900WEIKL

340 × 132 × 50 mm +/- 5 mm

kg 0,35 kg

passar till:  
universell användning



## BO-PE-900WEIGR

340 × 150 × 100 mm +/- 5 mm

kg 0,75 kg

passar till:  
universell användning

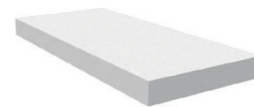

## BO-PE-900-03415

340 × 150 × 25 mm +/- 5 mm

kg 0,18 kg

passar till:  
universell användning



## BO-PE-900-SH-49

1355 × 140 × 49 mm +/- 5 mm

kg 1,45 kg

passar till:  
universell användning



## BO-PE-900-SH-95

1355 × 140 × 95 mm +/- 5 mm

kg 2,80 kg

passar till:  
universell användning



**BO-PB-K03415.H4**

340 × 150 × 40 mm +/- 5 mm

 0,20 kg

passar till:  
universell användning



**BO-PB-K03415.H6**

340 × 150 × 60 mm +/- 5 mm

 0,30 kg

passar till:  
universell användning



**BO-PB-K03415.H8**

340 × 150 × 80 mm +/- 5 mm

 0,40 kg

passar till:  
universell användning



**BO-PB-K15015.H4**

1500 × 150 × 40 mm +/- 5 mm

 0,90 kg

passar till:  
universell användning



**BO-PB-K15015.H6**

1500 × 150 × 60 mm +/- 5 mm

 1,30 kg

passar till:  
universell användning



**BO-PB-K15015.H8**

1500 × 150 × 80 mm +/- 5 mm

 1,60 kg

passar till:  
universell användning



BO-165029

c	d	h	l	w
160 mm	320 mm	13 mm	380 mm	260 mm

2,75 kg med stålplatta

passar till:  
J.A.B. BECKER



BO-GK402

c	d	h	l	w
240 mm	285 mm	15 mm	400 mm	350 mm

3,30 kg med stålplatta

passar till:  
SLIFT / IME



BO-GK4012

c	d	h	l	w
240 mm	255 mm	12 mm	400 mm	350 mm

3,10 kg med stålplatta

passar till:  
SLIFT / IME



BO-GK4035-VG

c	d	h	l	w
260 mm	355 mm	14 mm	400 mm	350 mm

3,60 kg ny version / med stålplatta

passar till:  
MAHA



BO-GK5312

c	d	h	l	w
240 mm	405 mm	12 mm	535 mm	350 mm

4,20 kg med stålplatta

passar till:  
SLIFT / IME

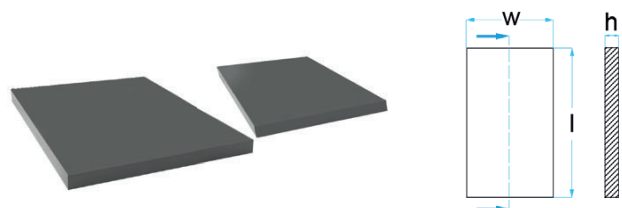

BO-GK342

h	l	w
20 mm	336 mm	290 mm

2,35 kg

passar till:  
SLIFT / IME / universell användning

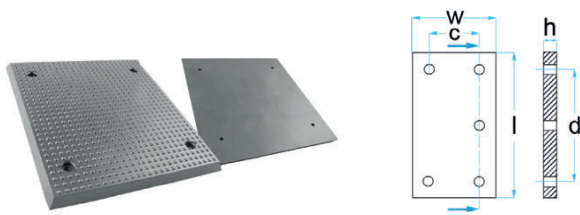

BO-GK392

c	d	h	l	w
240 mm	255 mm	20 mm	370 mm	330 mm

2,55 kg

passar till:  
MAHA / universell användning

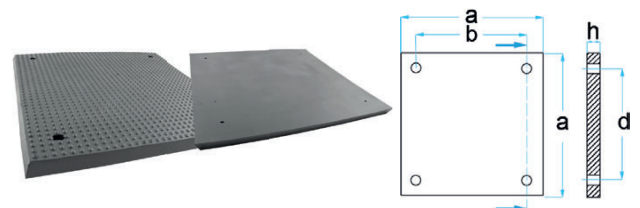

BO-GK452

a	b	c	d	h
450 mm	354 mm	-	354 mm	20 mm

5,70 kg

passar till:  
MAHA / universell användning

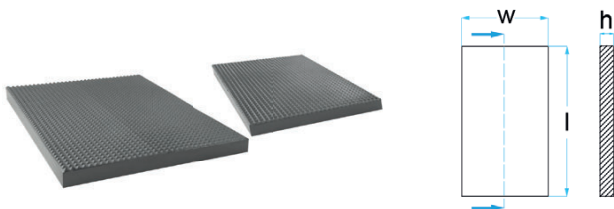

BO-37005BO

h	l	w
20 mm	270 mm	210 mm

1,35 kg

passar till:  
AUTOP-STENHOJ



BO-37006BO

c	d	h	l	w
320 mm	340 mm	12 mm	400 mm	350 mm

3,35 kg med stålplatta / ink. skruvkoppling

passar till:  
AUTOP-STENHOJ



BO-24003

c	d	h	l	w
230 mm	311 mm	40 mm	405 mm	305 mm

6,40 kg med stålplatta

passar till:  
AUTOP-STENHOJ / PERKUTE

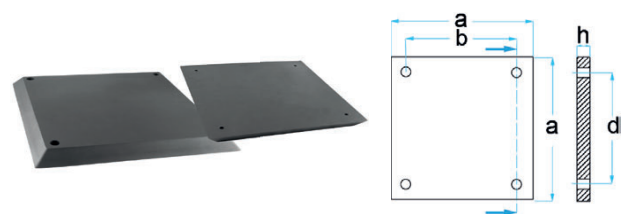

BO-235NT08022

a	b	c	d	h
325 mm	257 mm	-	257 mm	20 mm

2,70 kg

passar till:  
NUSSBAUM



BO-507176

c	d	h	l	w
80 mm	155 mm	12 mm	220 mm	120 mm

 0,85 kg med stålplatta

passar till:  
J.A.B. BECKER



BO-970527BO

h	l	w
30 mm	460 mm	300 mm

 5,50 kg

passar till:  
NUSSBAUM



BO-509281

c	d	h	l	w
130 mm	155 mm	12 mm	220 mm	170 mm

 1,25 kg med stålplatta

passar till:  
J.A.B. BECKER

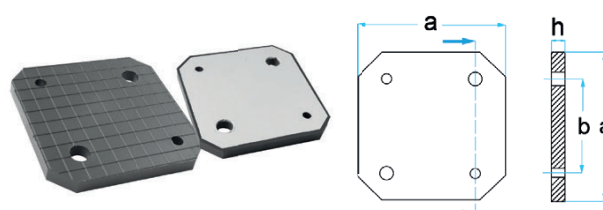

BO-WZ-00931-AO

a	b	c	d	h
150 mm	95 mm	-	-	120 mm

 0,75 kg med stålplatta

passar till:  
HYWEMA

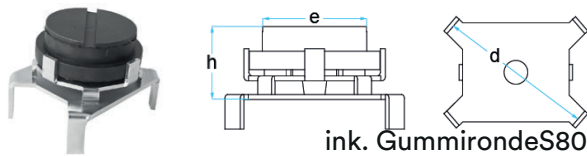

ink. GummirondeS80

### BO-LIFTADAPTE13

d	e	h
141 mm	85 mm	58 mm
0,71 kg    passar till lyfttassar med $\varnothing = 110-130$ mm		
passar till: Volvo S80 / universell användning		

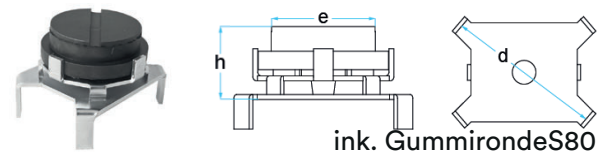

ink. GummirondeS80

### BO-LIFTADAPTE16

d	e	h
161 mm	85 mm	58 mm
0,75 kg    passar till lyfttassar med $\varnothing = 130-160$ mm		
passar till: Volvo S80 / universell användning		

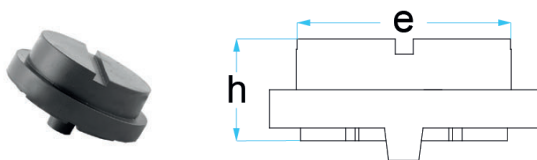

### BO-GUMMIRONDES8

a	e	h
-	85 mm	38 mm
0,30 kg		
passar till: LIFTADAPTERS80 / universell användning		

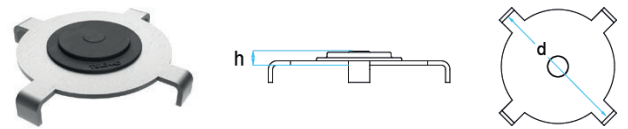

### BO-TSL3-AD-MEDI

a	d	h
-	141 mm	11 mm
0,45 kg    passar till lyfttassar med $\varnothing = 120-140$ mm		
passar till: Tesla Model 3 / Tesla Model Y		

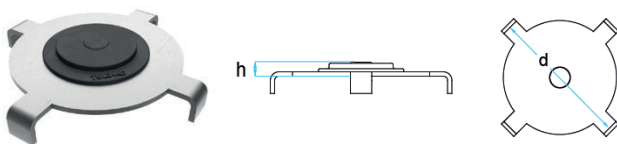

### BO-TSL3-AD-LARG

a	d	h
-	161 mm	11 mm
0,50 kg    passar till lyfttassar med $\varnothing = 140-160$ mm		
passar till: Tesla Model 3 / Tesla Model Y		

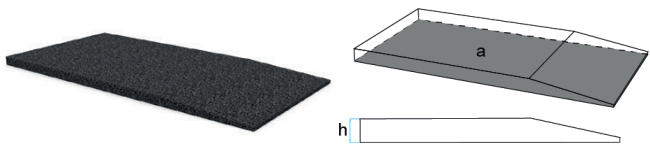

BO-GG-D1000.H30	
a	h
1000 × 500 mm	30 mm
kg 13,60 kg	
passar till: universell användning	

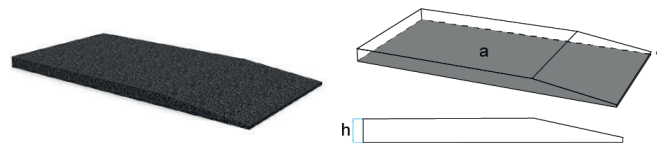

BO-GG-D1000.H40	
a	h
1000 × 500 mm	40 mm
kg 16,90 kg	
passar till: universell användning	

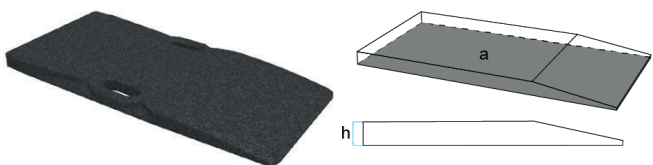

BO-GG-D1000.H50	
a	h
1000 × 480 mm	50 mm
kg 22,90 kg	
passar till: universell användning	

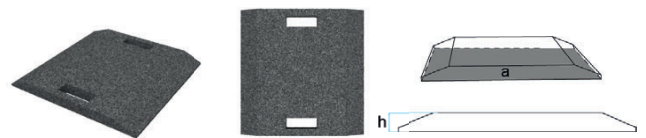

BO-GG2P-D500H40	
a	h
500 × 500 mm	40 mm
kg 8,40 kg	
passar till: universell användning	



BO-GG5X-S108H50	
a	h
500 × 500 mm	50 mm
kg 10,00 kg	
passar till: universell användning	

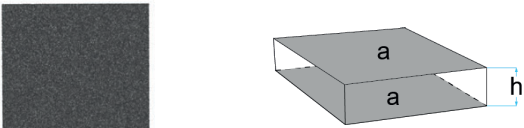

NY

**BO-IP500.500.50**

a	h
500 × 500 mm	50 mm

 13,00 kg utan handtag

passar till:  
Körbanesaxlyftar / 4-pelaryftar för hjulinställning

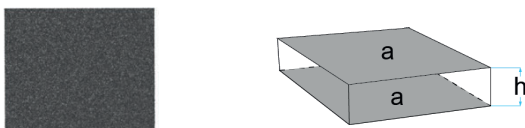

NY

**BO-IP510.470.50**

a	h
510 × 470 mm	50 mm

 11,90 kg utan handtag

passar till:  
Körbanesaxlyftar / 4-pelaryftar för hjulinställning

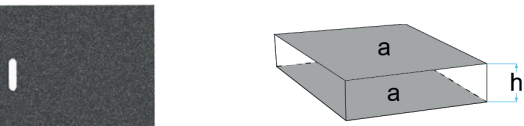

**BO-IP530.470.50**

a	h
530 × 470 mm	50 mm

 12,00 kg med handtag

passar till:  
Körbanesaxlyftar / 4-pelaryftar för hjulinställning

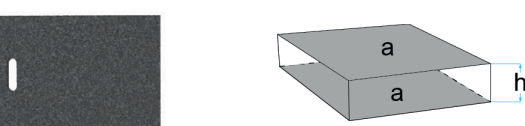

NY

**BO-IP550.400.50**

a	h
550 × 400 mm	50 mm

 11,20 kg med handtag

passar till:  
Körbanesaxlyftar / 4-pelaryftar för hjulinställning

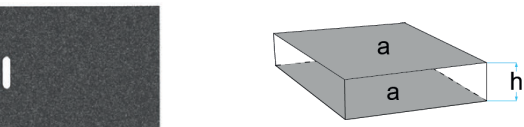

**BO-IP570.450.50**

a	h
570 × 450 mm	50 mm

 13,00 kg med handtag

passar till:  
Körbanesaxlyftar / 4-pelaryftar för hjulinställning

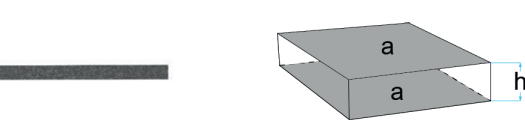

**BO-IP600.050.50**

a	h
600 × 50 mm	50 mm

 1,40 kg utan handtag

passar till:  
Körbanesaxlyftar / 4-pelaryftar för hjulinställning





## BO-IP600.100.50

a

h

600 × 100 mm

50 mm

 2,80 kg utan handtag

passar till:  
Körbanesaxlyftar / 4-pelaryftar för hjulinställning

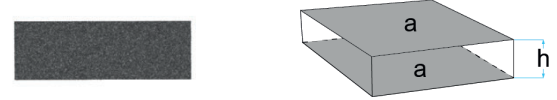

## BO-IP600.200.50

a

h

600 × 200 mm

50 mm

 5,60 kg utan handtag

passar till:  
Körbanesaxlyftar / 4-pelaryftar för hjulinställning

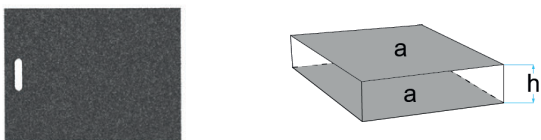

## BO-IP600.450.50

a

h

600 × 450 mm

50 mm

 13,00 kg med handtag

passar till:  
Körbanesaxlyftar / 4-pelaryftar för hjulinställning

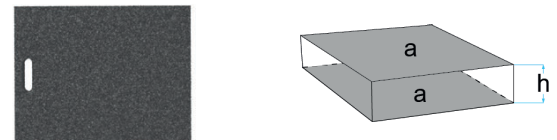

## BO-IP600.465.50

a

h

600 × 465 mm

50 mm

 14,00 kg med handtag

passar till:  
Körbanesaxlyftar / 4-pelaryftar för hjulinställning

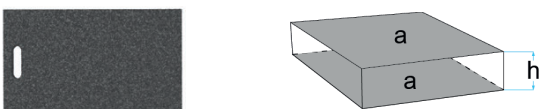

NY

## BO-IP607.360.50

a

h

607 × 360 mm

50 mm

 10,50 kg med handtag

passar till:  
Körbanesaxlyftar / 4-pelaryftar för hjulinställning

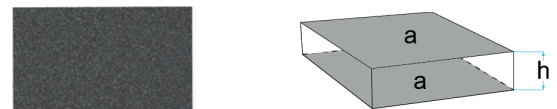

NY

## BO-IP610.375.50

a

h

610 × 375 mm

50 mm

 12,00 kg utan handtag

passar till:  
Körbanesaxlyftar / 4-pelaryftar för hjulinställning

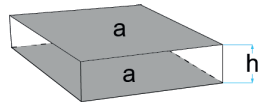

NY

BO-IP610.395.50

a

h

610 × 395 mm

50 mm

12,10 kg utan handtag

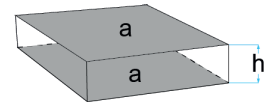
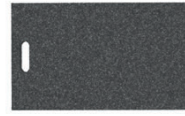
 passar till:  
 Körbanesaxlyftar / 4-pelaryftar för hjulinställning

BO-IP620.365.50

a

h

365 × 620 mm

50 mm

11,00 kg med handtag

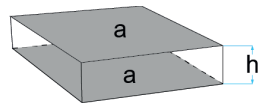
 passar till:  
 Körbanesaxlyftar / 4-pelaryftar för hjulinställning

BO-IP633.500.50

a

h

633 × 500 mm

50 mm

16,00 kg med handtag

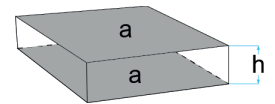
 passar till:  
 Körbanesaxlyftar / 4-pelaryftar för hjulinställning

BO-IP645.620.50

a

h

645 × 620 mm

50 mm

20,00 kg med handtag

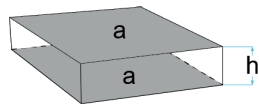
 passar till:  
 Körbanesaxlyftar / 4-pelaryftar för hjulinställning

NY

BO-IP650.050.50

a

h

650 × 50 mm

50 mm

1,68 kg utan handtag

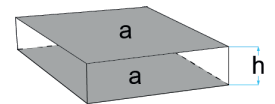
 passar till:  
 Körbanesaxlyftar / 4-pelaryftar för hjulinställning

NY

BO-IP650.080.50

a

h

650 × 80 mm

50 mm

3,00 kg utan handtag

 passar till:  
 Körbanesaxlyftar / 4-pelaryftar för hjulinställning

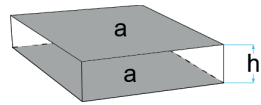

NY

BO-IP650.100.50

a

h

650 × 100 mm

50 mm

3,34 kg utan handtag

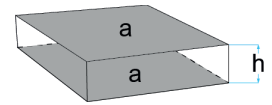
 passar till:  
 Körbanesaxlyftar / 4-pelaryftar för hjulinställning

NY

BO-IP650.120.50

a

h

650 × 120 mm

50 mm

4,10 kg utan handtag

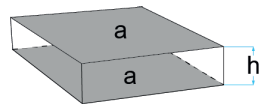
 passar till:  
 Körbanesaxlyftar / 4-pelaryftar för hjulinställning

NY

BO-IP650.200.50

a

h

650 × 200 mm

50 mm

6,45 kg utan handtag

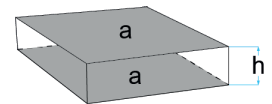
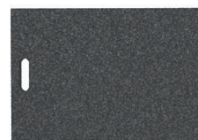
 passar till:  
 Körbanesaxlyftar / 4-pelaryftar för hjulinställning

BO-IP650.450.50

a

h

650 × 450 mm

50 mm

15,00 kg med handtag

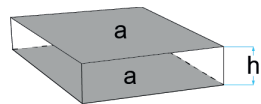
 passar till:  
 Körbanesaxlyftar / 4-pelaryftar för hjulinställning

BO-IP650.460.50

a

h

650 × 460 mm

50 mm

15,00 kg med handtag

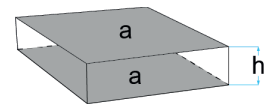
 passar till:  
 Körbanesaxlyftar / 4-pelaryftar för hjulinställning

BO-IP680.400.50

a

h

680 × 400 mm

50 mm

14,00 kg med handtag

 passar till:  
 Körbanesaxlyftar / 4-pelaryftar för hjulinställning

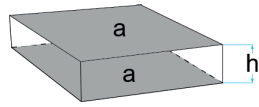

BO-IP680.430.50

a

h

680 × 430 mm

50 mm

14,90 kg med handtag

passar till:  
Körbanesaxlyftar / 4-pelaryftar för hjulinställning

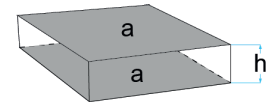

BO-IP730.650.50

a

h

730 × 650 mm

50 mm

23,00 kg med handtag

passar till:  
Körbanesaxlyftar / 4-pelaryftar för hjulinställning



NY

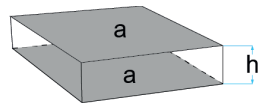

BO-IP1000.50050

a

h

1000 × 500 mm

50 mm

25,00 kg utan handtag

passar till:  
Körbanesaxlyftar / 4-pelaryftar för hjulinställning



NY

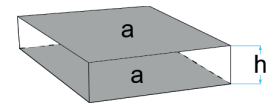

BO-IP1100.60050

a

h

1100 × 600 mm

50 mm

34,00 kg utan handtag

passar till:  
Körbanesaxlyftar / 4-pelaryftar för hjulinställning



NY

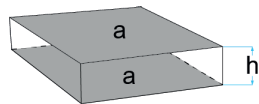

BO-IP2000.50050

a

h

2000 × 500 mm

50 mm

50,00 kg utan handtag

passar till:  
Körbanesaxlyftar / 4-pelaryftar för hjulinställning





POWERED  
**by KGK**

