

**MXN<sup>®</sup>**  
**OWNER'S MANUAL**

**5" Digital LCD monitor  
for allround vision**

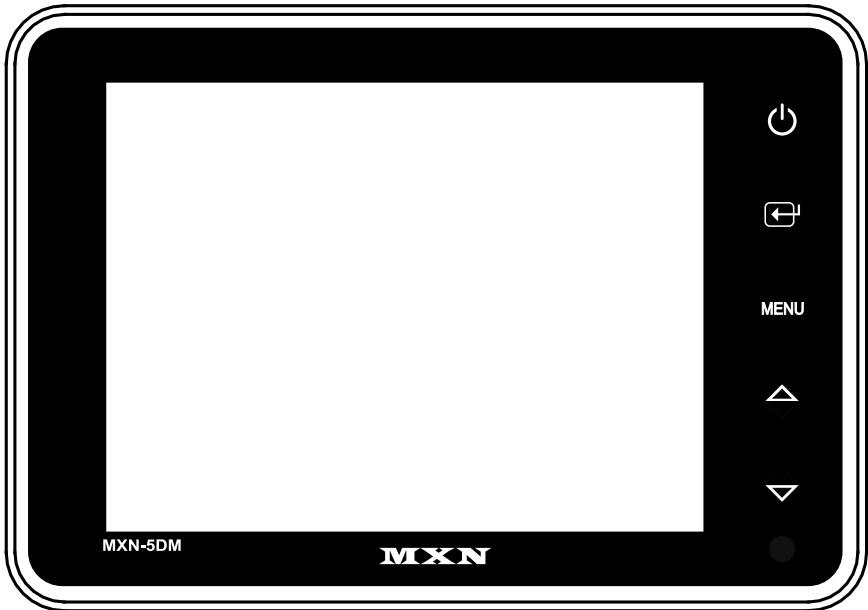

**Model : MXN-5DM**

Design and Specifications are subject to change without notice.

**Model : MXN-5DM**

# **INDEX**

<b>Safety Instructions</b>	<b>..... 03</b>
<b>Package Contents</b>	<b>..... 04</b>
<b>Operation</b>	<b>..... 05</b>
<b>System Setting</b>	<b>.... 07~12</b>
<b>Camera setting</b>	<b>..... 07</b>
<b>Trigger setting</b>	<b>..... 08</b>
<b>Auto Scan setting</b>	<b>..... 10</b>
<b>Day/Night setting</b>	<b>..... 10</b>
<b>Advanced menu</b>	<b>..... 11</b>
<b>Installation</b>	<b>..... 13</b>
<b>Connection</b>	<b>..... 14</b>
<b>Specification</b>	<b>..... 15</b>

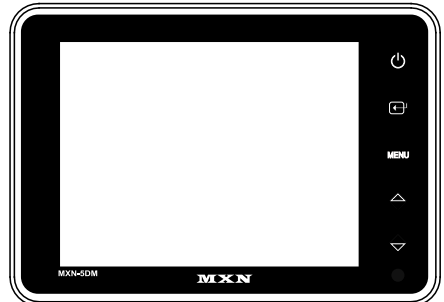

# Safety Instructions

## WARNING

- To avoid electric shock, do not open the cabinet. Refer servicing to qualified personnel only.

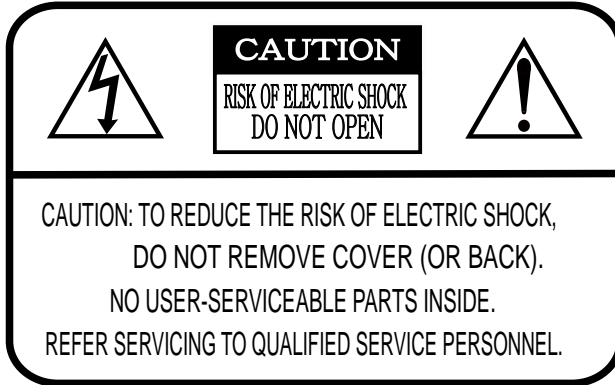

This symbol is intended to alert the user to the presence of uninsulated "dangerous voltage" within the product's enclosure that may be of sufficient magnitude to constitute risk of electric shock to persons.



This symbol is intended to alert the user to the presence of important operating and maintenance (servicing) instructions in the literature accompanying the appliance.

- Use only DC 12V~DC 30V.
- In case that dust or liquid was soaked into the housing, please turn off power and consult an experienced technician before using.
- Do not install the unit in an extremely hot or humid place(radiator, air duct, etc.) or in a place subject to direct sunlight, excessive dust, mechanical vibration or shock
- If your vehicle has been parked in direct sun light resulting in a considerable rise in temperature inside the vehicle, allow the unit to cool off before operating
- Clean the unit with a slightly damp soft cloth  
Use a mild household cleaner  
Never use strong solvents such as thinner or benzine as they might damage the finish of the unit.

# Package Contents

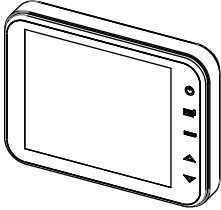

MONITOR

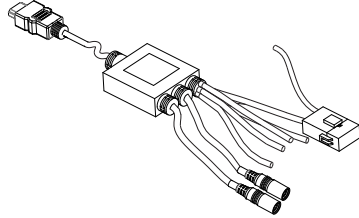

CAMERA INPUT CABLE

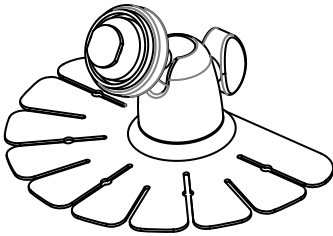

(RAIL TYPE)  
FIXING BRACKET

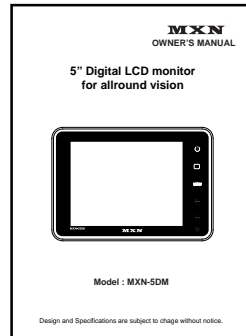

USERS MANUAL

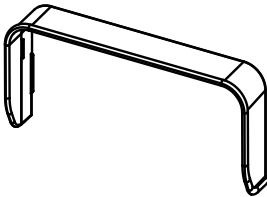

SUNVISOR



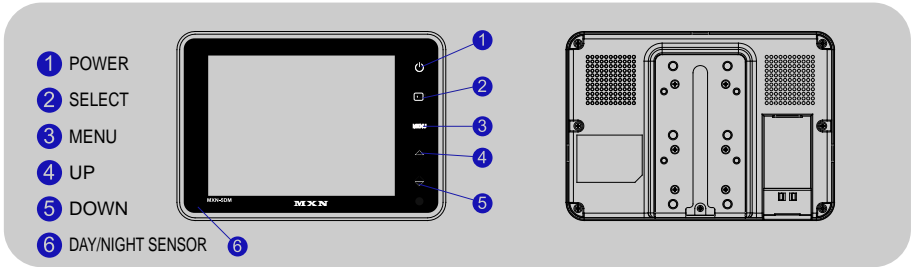

SCREW KIT

# Operation



## ① POWER





- Touch  icon to turn the monitor on.
- Touch  icon to turn the monitor off.

\* NOTE - Monitor start mode will follow "AUTO POWER" setting.

## ② SELECT



- Touch  icon to select CAMERA.
- Touch  icon to select the option in SET UP MENU.

## ③ MENU



- Touch  icon to enter Display Menu(Short key) and Main Menu(Long key).
- Touch once to enter menu mode.

**MENU**



- Touch again to exit from menu mode.
- Selectable OSD Menu Disappears within 10 sec if there's no new button (icon) pressed.
- Touch menu button over 2 sec to go back to main menu from display menu.

## ④ UP ⑤ DOWN



- While in Menu mode,  and  navigate through the available menu options.



- Touch   to adjust Bright, Contrast, Color, Sharpness, Tint Volume and other setting values.

## ⑥ DAY/NIGHT SENSOR (Photo T.R)

- Automatic Brightness Control



The brightness of the monitor is adjusted automatically by the Photo T.R accordingly to the circumstance.

# Operation

## ▼ DISPLAY MENU



Short Key  
(more than Touch 1 sec)

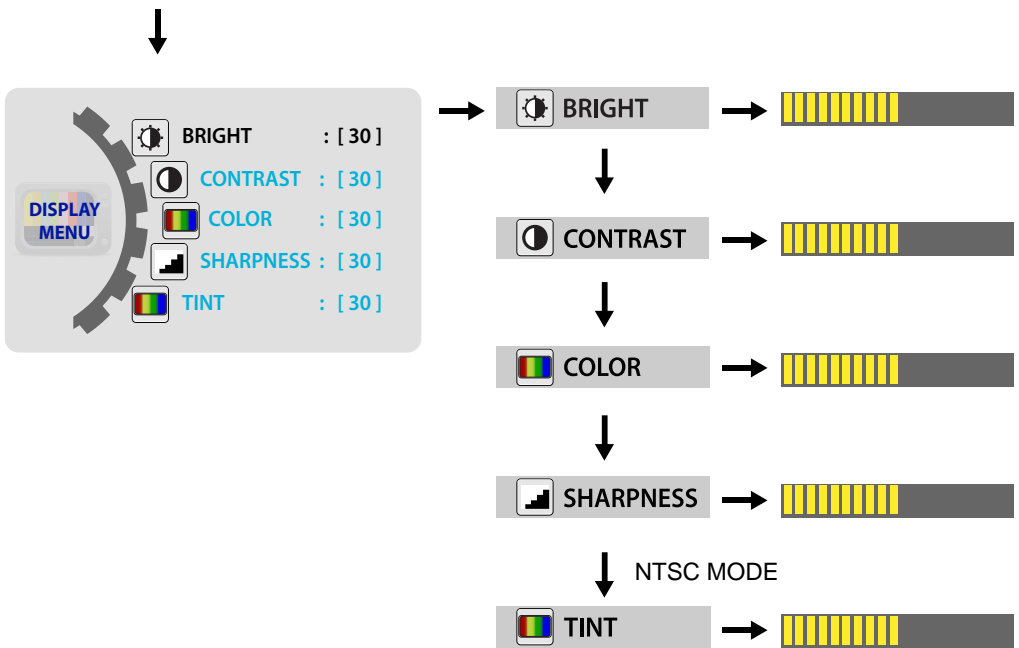

\* "TINT" menu is displayed in NTSC only.

- Shortkey Menu can control Bright, Contrast, Color and Sharpness, Tint for individual channel ( CAM1, CAM2 )  
How to adjust : Select camera ( CAM1, CAM2 ) and press the "Menu" icon with short time.  
Now you can adjust.

# System Setting

## ▼ SETUP MENU

Touch MENU icon for a while (over 2 sec) to enter MAIN MENU.

Selectable OSD MENU disappears within 10 sec if there is no new icon touched.

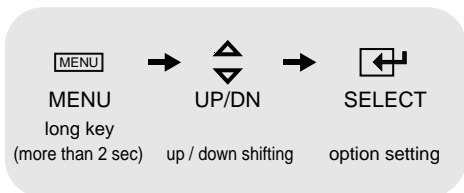

## 1. CAMERA SETTING

- Camera setting menu can control “MIR/NOR”, “UP/DOWN”, “CAMERA NAME,” “SORT” for individual camera (CA1,CA2)

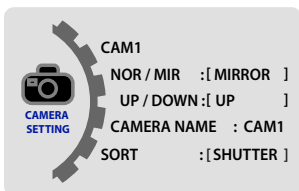

### SUBDIVISION MENU

#### ● NOR/MIR

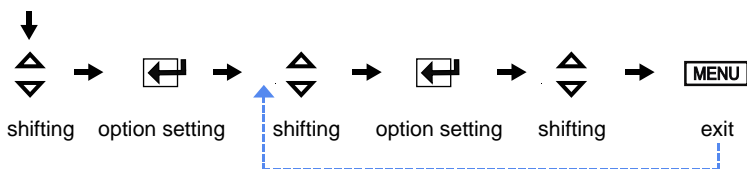

#### ● UP/DOWN: [UP, DOWN]



#### ● SORT: [NORMAL, SHUTTER]



#### ● CAMERA NAME: [CAM1or2, FRONT, REAR, LEFT, RIGHT, SIDE, CENTER, ROOM]



# System Setting

## 2. TRIGGER SETTING

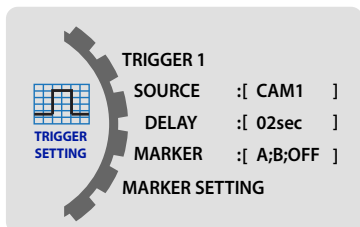

TRIGGER 1  
 SOURCE :[ CAM1 ]  
 DELAY :[ 02sec ]  
 MARKER :[ A;B;OFF ]  
 MARKER SETTING

SOURCE: [CAM1 => CAM2 => SKIP]

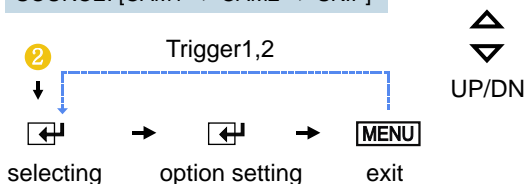

- ✓ User can use 2 triggers and each trigger source (CAM1,2) can be selected.
- ✓ When the trigger is activated, the selected source's image is displayed.

DELAY:[0~20SEC]

- ✓ Each trigger's delay time is adjustable from 0 sec to 20 sec.

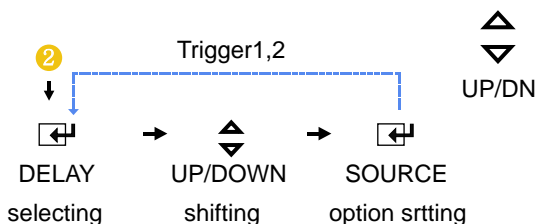

- \* NOTE
- Source select, Delay time setting and MARKER ON/OFF are only available with  (SELECT) key.
  - If one Trigger is activated by an intermittent signal (e.g. from an indicator light's) the delay must be activated to prevent the picture from flickering.



# System Setting

MARKER:[A;B;OFF]



MARKER SETTING

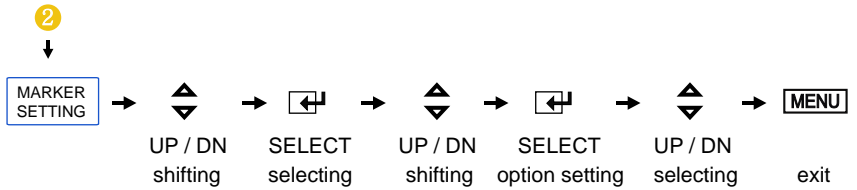

A

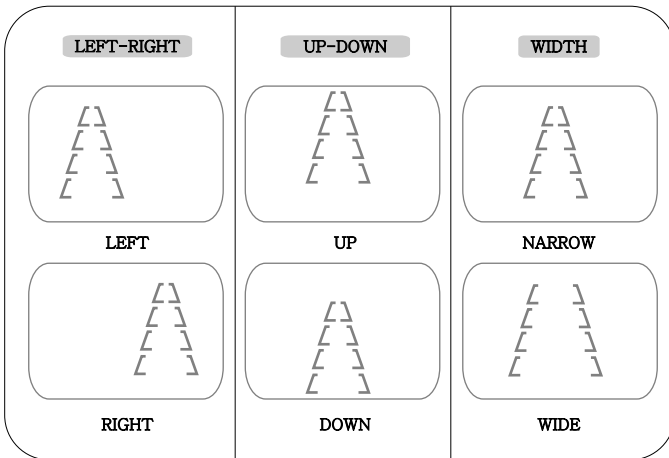

B

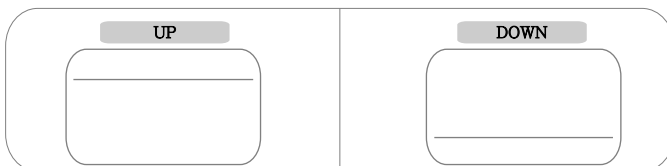

# System Setting

## 3. AUTO SCAN SETTING

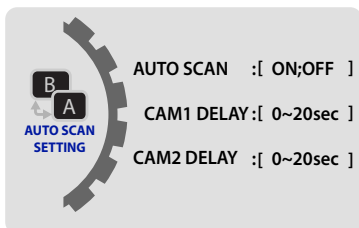

### AUTO SCAN DELAY SETTING

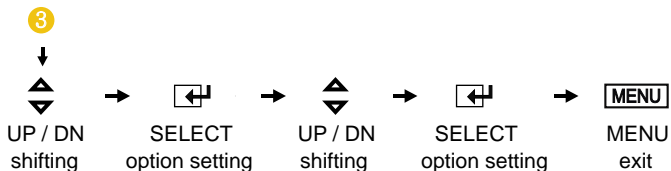

### AUTO SCAN:[ON;OFF]

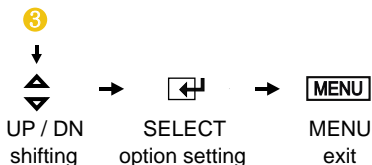

## 4. DAY/NIGHT SETTING

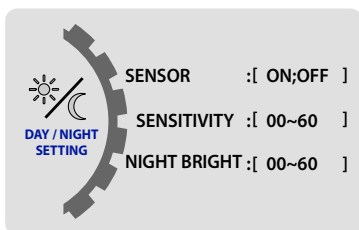

SENSOR: [ON;OFF]

SENSITIVITY: [0~60]

NIGHT BRIGHT: [0~60]

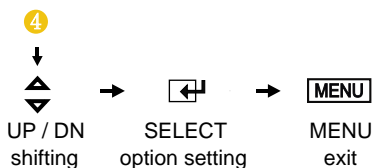

# System Setting

## 5. ADVANCED MENU

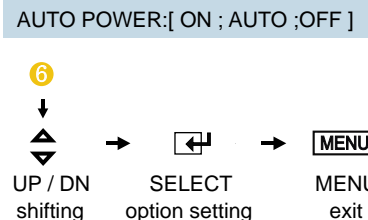
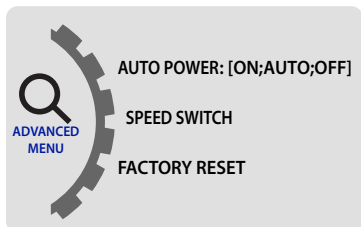

### \* NOTE

- Auto Setting Monitor keeps the last setting in memory: Monitor will start up "Power-on" mode or "Stand- by" mode according to its last mode before the ignition key off.
- Off Setting Monitor keeps "Stand- by" setting regardless of the last mode before the ignition key off.
- On setting: Monitor will be turned on automatically when ignition key on regardless of the last mode of the monitor before the ignition key off.

## SPEED SWITCH

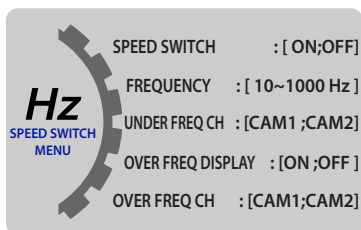

### ● SPEED SWITCH: [ON;OFF]

- \* NOTE - Select "ON" for enter into the function.
- Select "OFF" for get out the function.

### ● FREQUENCY: [10~1000Hz]

- \* NOTE - Select activated frequency 10~1000Hz.
- Press "SELECT" button short for 1Hz frequency steps change.
- Press "SELECT" button long for 10Hz frequency steps change.

### ● UNDER FREQ CH: [CAM1;CAM2]

- \* NOTE - Activates selected channel when input is lower frequency than frequency setting.

### ● OVER FREQ DISPLAY: [ON;OFF]

- \* **NOTE** - Select :ON" for displaying image when input is higher frequency than frequency setting.

### ● OVER FREQ CH: [CAM1;CAM2]

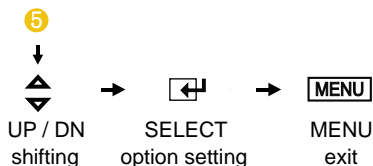

- \* NOTE - Activates channel image when input is higher frequency than frequency setting.

# System Setting

## ◎ EXAMPLE OF SPEED SWITCH FUNCTION:

- \* The orange wire needs to be connected with the vehicle's tacho signal and via MENU the SPEED SWITCH needs to be selected ON.
- \* Adjust FREQUENCY into 67Hz. At this setting (and most common used tacho signal), the selected camera will be displayed during a speed of 0~33km/h.
- \* Select the concerning camera via "UNDER FREQUENCY CH;" (At different type tacho signals, the FREQUENCY needs to be adjusted into higher or lower value than this example)
- \* Over 33km/h (72Hz), the selected camera will be switched OFF automatically. When the speed slows down, then the selected camera will be switched ON automatically again at 30km/h. Instead of automatic switch OFF at a speed over 33km/h it is also possible to activate another video source, such as a navigation picture from an optional navigation computer. In this case, user needs to select "OVER FREQUENCY DISPLAY: ON" and user needs to select "OVER FREQUENCY CH"
- \* In case of TRIGGER activation during "SPEED SWITCH ON" mode, than TRIGGER 1,2 will overrule "SPEED SWITCH" function.

## FACTORY RESET

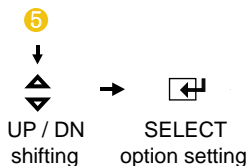

## ★ LOCK ON/FF FUNCTION

### LOCK ON/FF FUNCTION

The set up menu can be prevention against unauthorized users.

#### LOCK ON mode

At Power-ON mode, hold  icon pressed for 10 seconds to set up LOCK ON Function.

When [ LOCKED ] is displayed on the screen, user can use [ POWER, SELECT, VOLUME ] buttons only and use can do setting for PICTURE menu.(Short key)

#### LOCK OFF mode

At Power-ON mode, hold  icon pressed for 10 seconds to set up LOCK OFF Function.

When [ UNLOCKED ] is displayed on the screen, user can use all functions of the set up menu.

- When [ LOCKED ] or [ UNLOCKED ] is displayed on the screen, user can select [ LOCKED ] or [ UNLOCKED ] by pressing  icon.
- After selection [ LOCKED ] or [ UNLOCKED ] , press POWER button.  
Then, press POWER button again to activate the proper LOCK ON/OFF function.

# Installation

## 1. Monitor Fixing Methode

### 1) STAND BRACKET (RAIL TYPE)

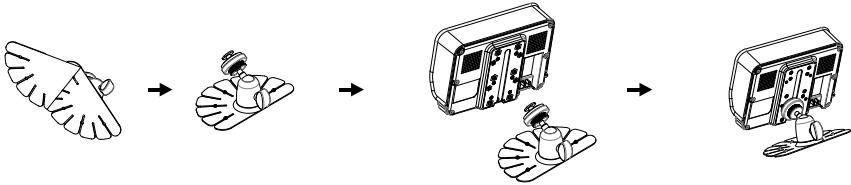

### 2) ROOF MOUNT BRACKET : OPTION

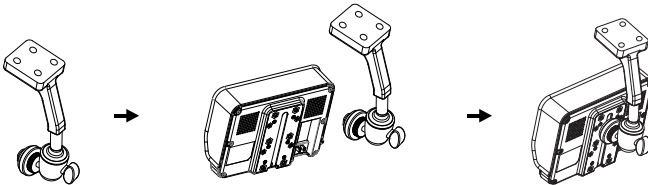

### 3) WINDOW BRACKET: OPTION

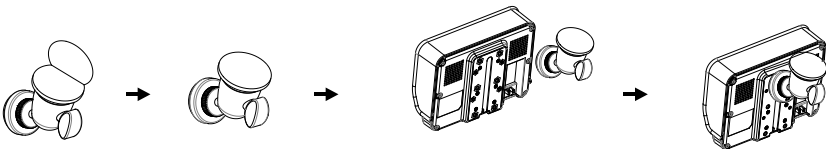

## 2. Sunvisor Mounting Method

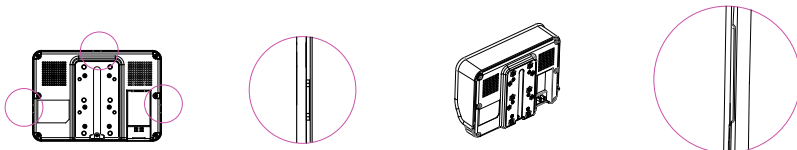
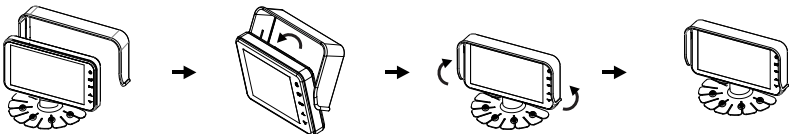

# Connection

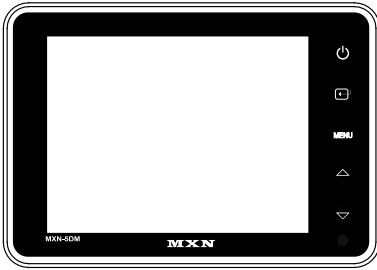

## POWER/TRIGGER WIRE FUNCTIONS

REF#	WIRE COLOR	DESCRIPTION
1	RED	POWER IN DC (12 TO 30V)
2	WHITE	TRIGGER2
3	GREEN	TRIGGER1
4	ORANGE	SPEED SWITCH (TACHO SIGNAL)
5	BLACK	GROUND

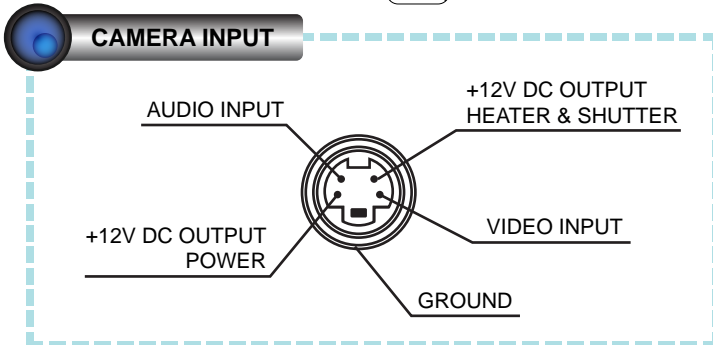
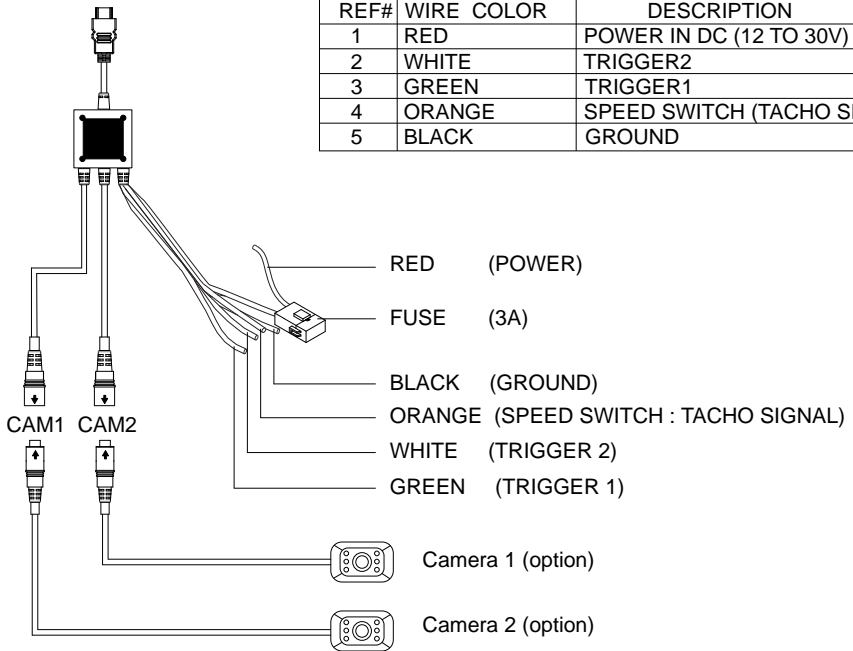

# Specification

## MXN-5DM

Power Input	DC 12V~30V
Power Consumption	Max. 12Watt
Video System	NTSC / PAL compatible
Panel	5" Digital
Resolution	640 (H) x 480 (V) x 3 (RGB)
Format	4:3
Camera input(2CH)	Mini DIN 4P, 1Vp-p 75Ω
Operating Temp.	-30°C ~ +80°C
Storage Temp.	-40°C ~ +90°C
Vibration	6G
OSD Control	Day & Night Sensor & Sharpness Bright, Contrast, Color, Tint Mirror/ Normal, Day/ Night Mode/ Scale *Individual Control per Channel available
Dimension	149 (W) x 104 (D) x 29(H) mm 5.9 (W) x 4.1 (D) x 1.14 (H) inch
Weight	Approx. 410g
Supplied acc`y	Camera Input Cable : (1) Screw Kit : (1) Stand Bracket : (1) Sun Visor : (1) Instruction Manual : (1)



THIS SYMBOL MEANS DO NOT DISPOSE OF  
AS MUNICIPAL WASTE.  
RE-USE OR RECYCLE WHEREVER POSSIBLE.  
ELECTRICAL / ELECTRONIC COMPONENTS MAY  
CONTAIN SUBSTANCES WHICH ARE HARMFUL TO  
THE ENVIRONMENT.  
FOR ENVIRONMENTALLY SOUND METHODS OF  
DISPOSAL, PLEASE CONTACT YOUR LOCAL  
GOVERNMENT AUTHORITY.

printed in korea