



Mastercool[®] Inc.

"World Class Quality"

PART# 91000-A

Deluxe A/C Clutch Hub Puller & Installer

REMOVING PROCEDURE:

1. Remove shaft nut or retaining ring.
2. Thread removing tool onto hub. Position center screw against the end of compressor shaft.
3. Hold body of remover with wrench and turn center screw into remover body to remove clutch hub assembly.

INSTALLING PROCEDURE:

1. Ensure frictional surface of clutch plate and rotor is clean.
2. Align shaft key with shaft keyway and place clutch plate and hub assembly on compressor shaft.
(Do not drive or pound on clutch hub or shaft, as this may cause internal damage to compressor.)
3. Attach installing tool onto compressor shaft.
(Body of installing tool should be backed off sufficiently to allow center screw to be threaded fully onto end of compressor shaft).
4. Hold center screw with wrench and tighten hex portion of installer to press hub onto shaft.
5. Tighten body several turns until the air gap between the friction surfaces is .020 - .030 inch.
6. Remove installer and check for proper positioning of shaft key.
7. Install shaft nut or retaining ring.
(Refer to manufacturer specification for correct torque).
8. Spin pulley by hand to check for free operation.

WARNING!

- Puller parts can break under stress!
- Be aware of hand positions.
- Wear safety goggles (user and bystanders)!
- Read and follow instructions.
- Do not heat pullers!
- Broken parts can cause injury!
- Do not over stress pullers!
- Avoid contact with refrigerant!

Removers

Installers

Removers

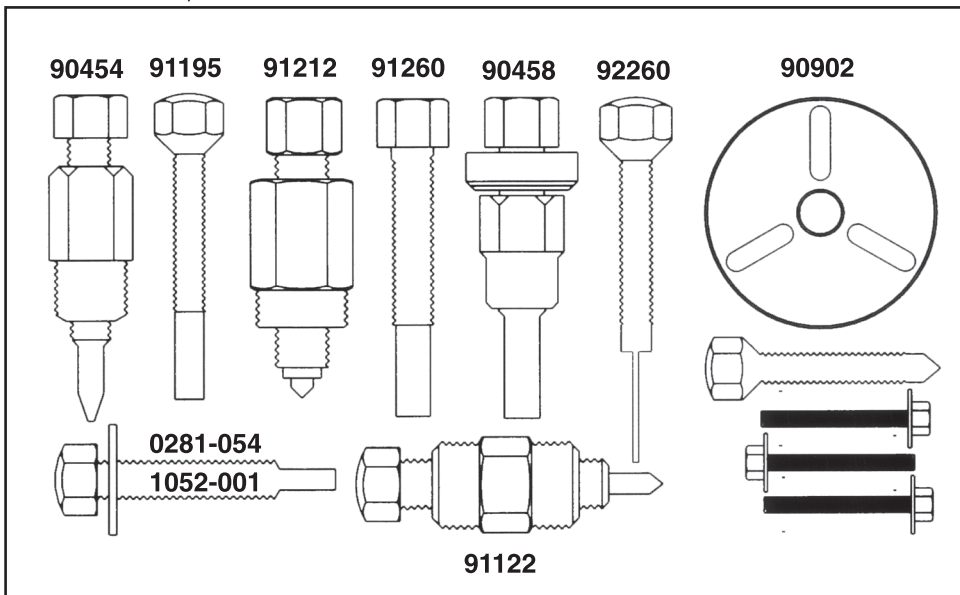

Installer

Remover/Installer

Compressor Type Used

Vehicles from (1989 - present)

Make	Nippon	Sanden	York Tecumseh	Harrison	Zexel Hitachi	Seiko Seiki	Diesel Kiki
Acura	X						
American Motors		X					
Audi	X		X				
BMW		X	X				
Buick				X			
Cadillac				X			
Chevrolet				X			
Chevrolet Truck				X			
Chrysler	X						
Dodge	X						
Dodge Truck	X	X					
Eagle	X	X					
Fiat		X					
Ford	X	X					
Ford Truck	X	X					
GMC Truck				X			
Honda	X						
Hyundai		X					
Infinity					X		
Isuzu				X			
Jaguar		X	X	X			
Jeep		X	X				
Lexus	X						
Lincoln	X						
Mazda	X						
Mercedes Benz			X	X			
Mercury	X						
Mitsubishi	X						
Nissan					X		
Oldsmobile				X			
Peugeot		X					
Plymouth	X						
Plymouth Truck	X						
Pontiac				X			
Porsche		X	X				
Renault		X					
Saab						X	
Saturn					X		
Subaru		X	X				
Suzuki	X						
Toyota	X						
Volkswagon	X	X	X				
Volvo							X

Make	Remover	Installer
Harrison GM DA-6, HR-6 & V5	91212 Nut & Arbor	90458 Nut, Bearing & 91260 Arbor
A-6 & Earlier R4	90454 Nut & Arbor	90458 Nut, Bearing & Arbor
R4	90454 Nut & 91195 Arbor	90458 Nut, Bearing & 91260 Arbor
Nippondenso Ford / Chrysler A590, C171 & FS-6	91122 Nut & 91212 Arbor	90458 Nut & 1052-001 Arbor & Washer
For FS-6 W / Special 24mm x 2.0	91122 Nut & Arbor	90458 Nut & 1052-001 Arbor & Washer
New Style	90454 Nut & Arbor	90458 Nut & 1052-001 Arbor & Washer
Sanden	90902 Puller Plate & Arbor	
York / Tecumseh HR980	91122 Nut & 91212 Arbor	90458 Nut & 1052-001 Arbor & Washer
Zexel / Mitsubishi CH Series	92260 Arbor & 90902 Puller Plate	

COMPRESSOR IDENTIFICATION

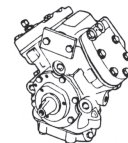

Chrysler
RV2

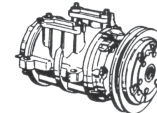

Nippondenso
A590

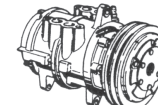

C171

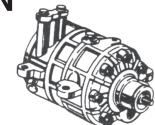

Chrysler Nippondenso
Variable Displacement
Compressor

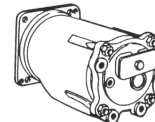

Harrison
Axial (A-6)

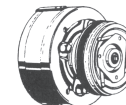

Harrison
Radial (R-4)

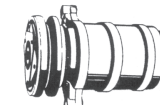

Harrison
DA-6/HR-6/HE-6

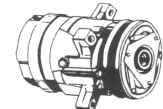

Harrison
V-5 Compressor

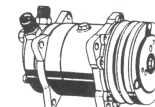

Sankyo (Sanden)
SD508

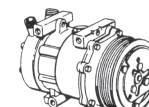

SD709

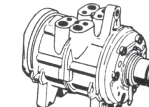

6P148

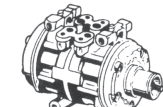

Nippondenso 10P15

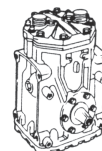

York & Tecumseh

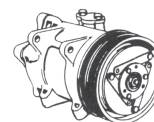

Hitachi

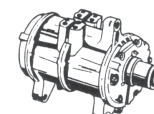

FS-6

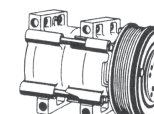

Ford FX-15

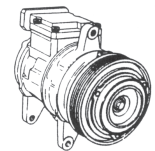

Nippondenso 10PA17