

➤ Instructions

Thule Dynamic
6128, 6129

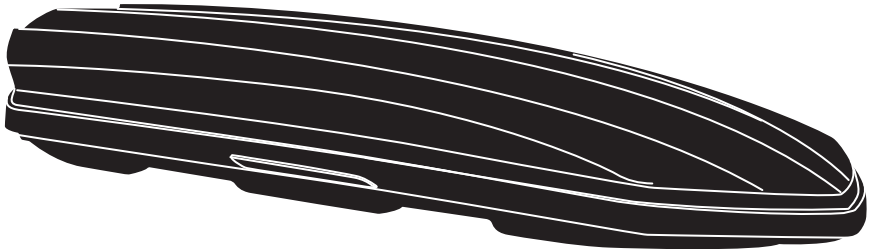

EN Roof box for roof-mounted racks
DE Dachbox für Dachträger
FR Coffre pour barres de toit
NL Dakkoffer
IT Box da tetto per portapacchi da installare sul tetto
ES Cofre portaequipajes para barras de techo
PT Caixa bagageira para barras de tejadilho
SV Takbox för takmonterade räckor
DK Tagboks til tagbjælter
NO Takboks til takmonterte stativer
FI Katolle asennettaviin telineisiin sopiva kuljetuslaatikko
ET Katusele paigaldatav katuseboks
LV Jumta kaste uz jumta uzstādāmiem bagāžniekiem
LT Ant stogo tvirtinamų skersinių bagažinės
PL Box dachowy na bagażnik montowany na dachu
RU Грузовой бокс на крышу автомобиля
UK Вантажний бокс для багажників для даху
BG Кутия за багаж за релси, монтирани върху покрива
CS Střešní box pro montáž na střechu
SK Strešný box na strešné nosiče

SL Strešni kovček za strešne prtljažnike
HR/BIH Krovna kutija za krovne nosače
RO Portbagaj de acoperiş pentru cadru de bare montate pe acoperiş
HU Tetőre szerelhető tetőbox
EL Μπαγκάζιέρα οροφής για μπάρες οροφής
TR Araç üstüne bağlanan raflar için tavan kutusu
HE תא חפצים לגג הרכב
AR صندوق سقف للحوامل المثبتة على السقف
ZH 用于车顶架的车顶箱
JA ルーフマウント型ラック用ルーフボックス
KO 루프 장착 랙 루프 박스
TH กล่องบนหลังคาสำหรับแร็คหลังคา



CITY CRASH
 Complies with ISO norm

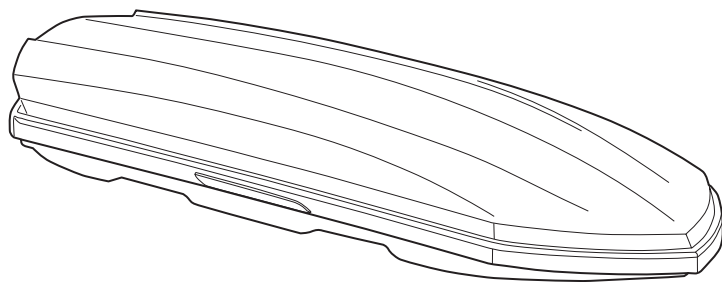
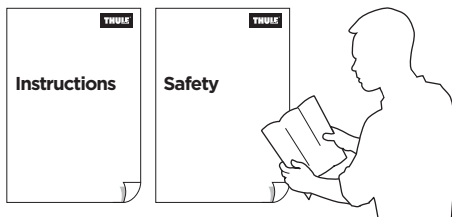

x1



x1



x3



x2

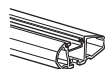

Thule WingBar Evo

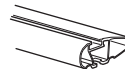

Thule WingBar

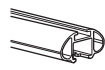

Thule AeroBar



Thule SlideBar



Thule Squarebar

i

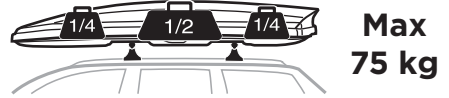

Dynamic 800/M	18 kg
Dynamic 900/L	22 kg

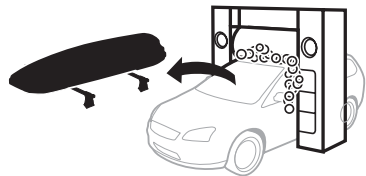
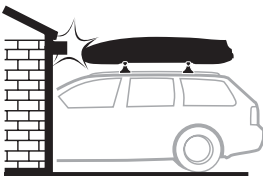
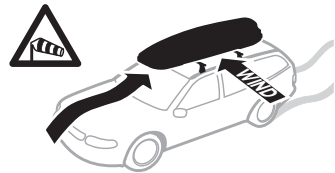
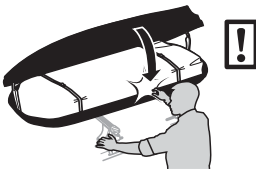
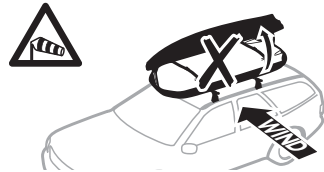
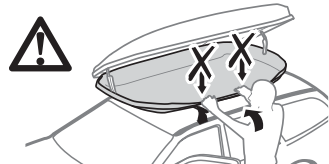
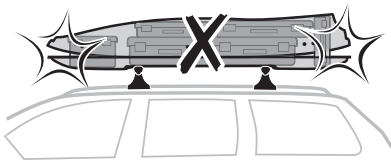
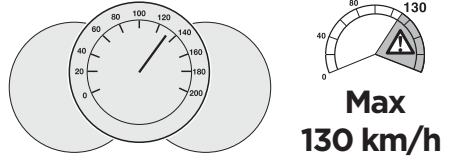

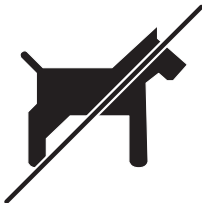
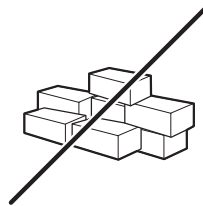
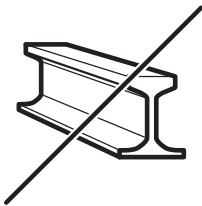
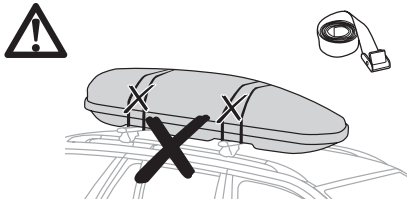
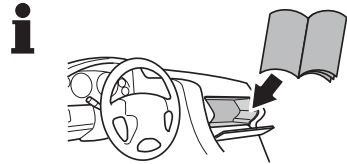
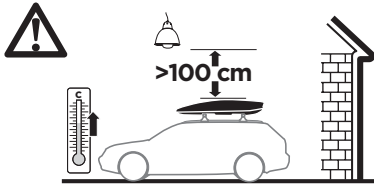
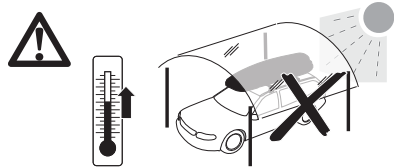
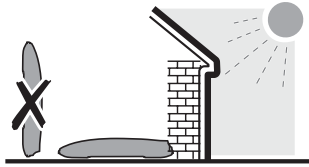

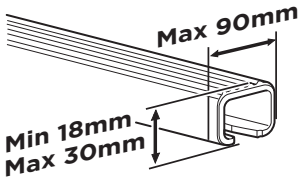

Thule T-track Adapter

696600

697600

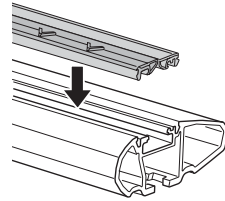
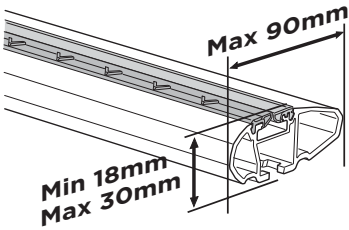
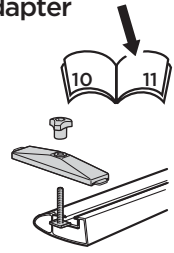

	D Min*	D Max*	W in*	W out*	H*	R Min*
Dynamic 800/M	555	935	736	735	304	1268
Dynamic 900/L	555	935	831	828	308	1363

* mm

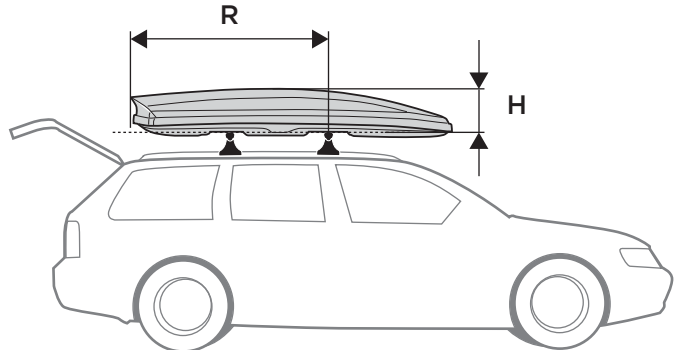
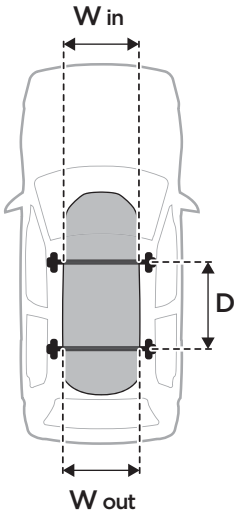

1

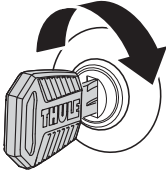

b

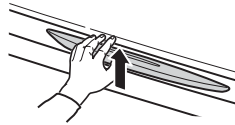
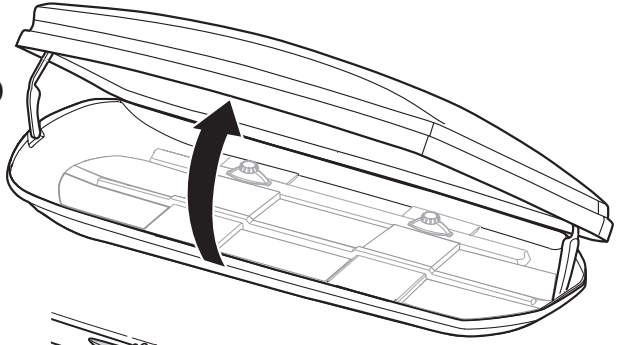

2

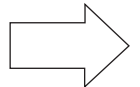
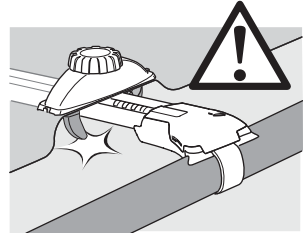
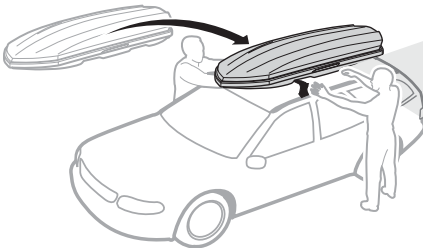
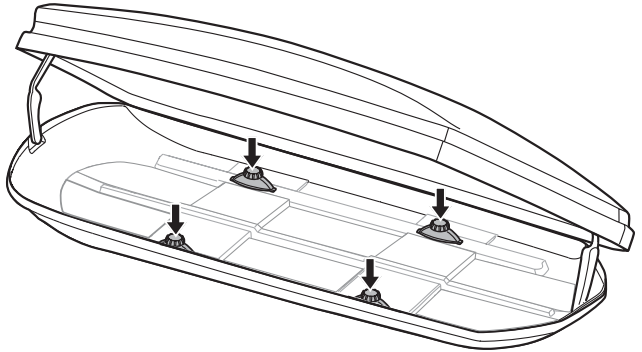
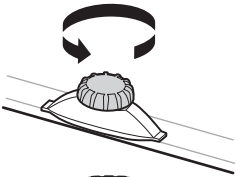

2

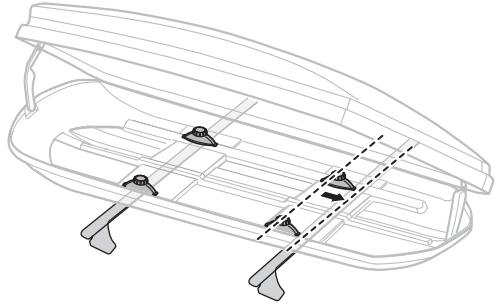
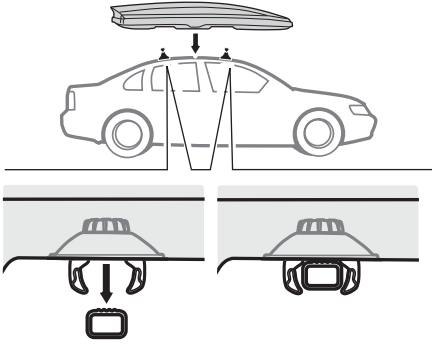
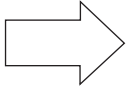

3

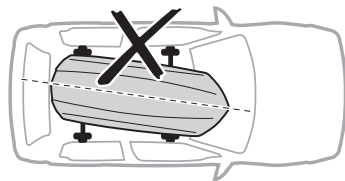
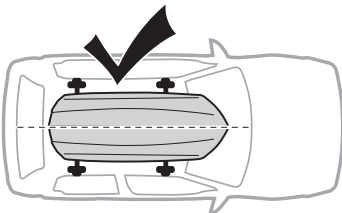
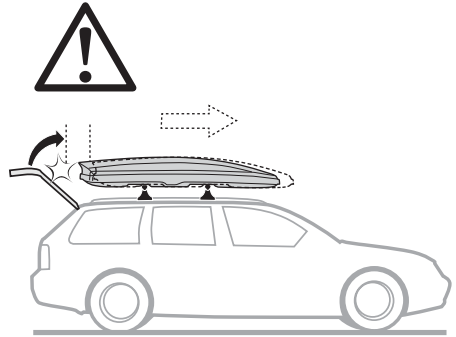
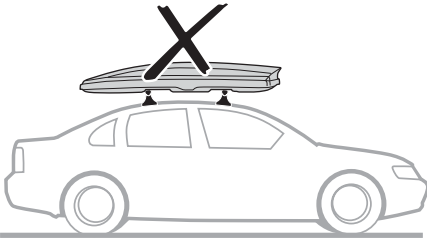

4

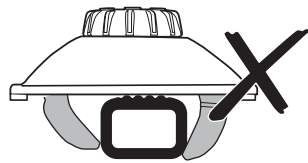
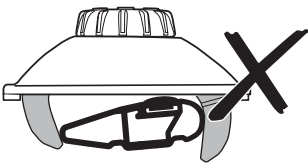
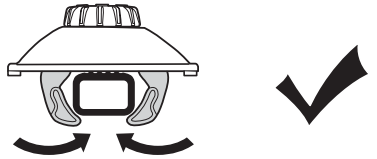
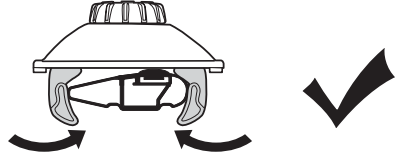
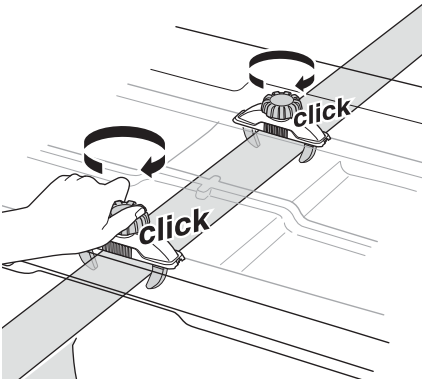
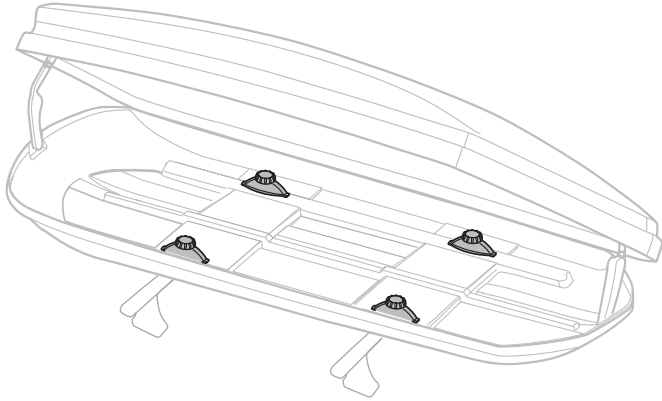

5



x 3

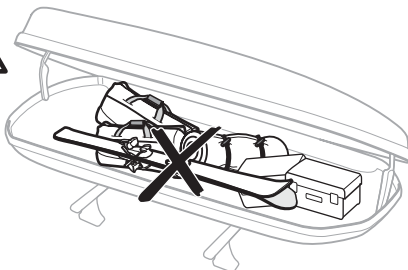
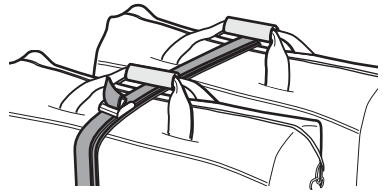
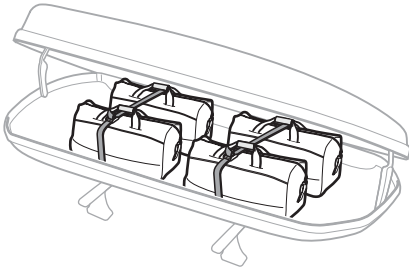
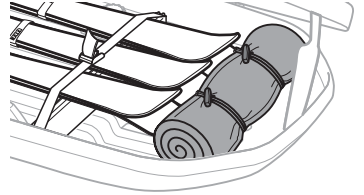
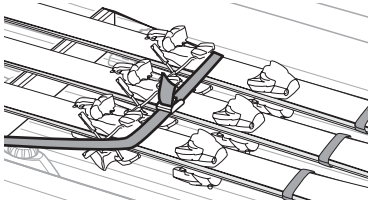
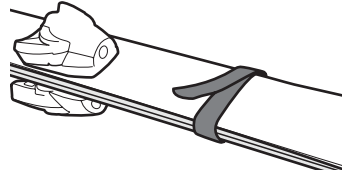
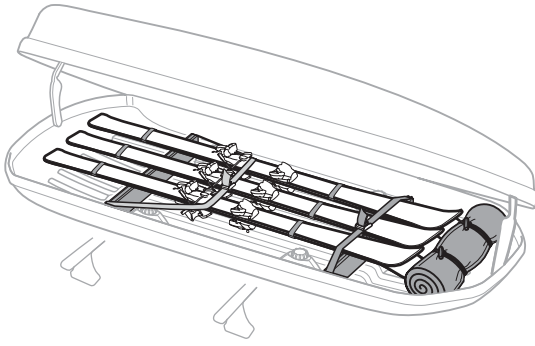
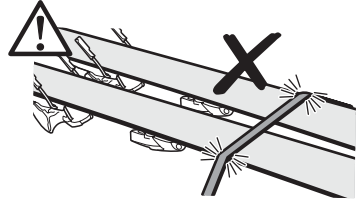
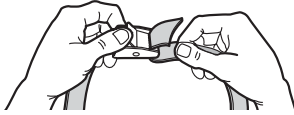

6

a

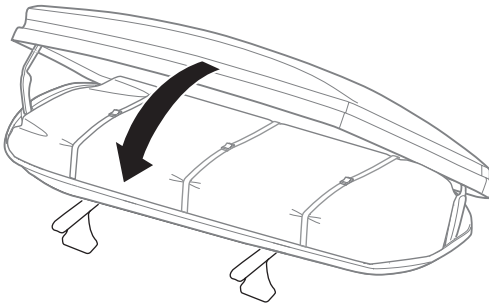

b

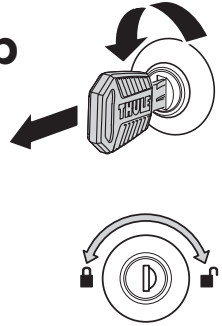

7

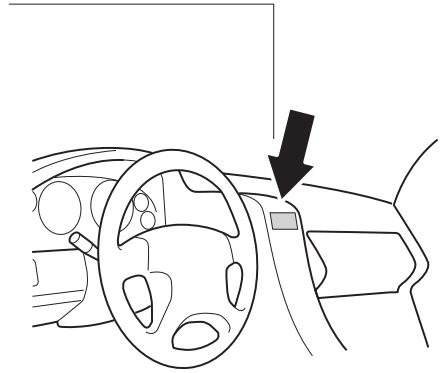
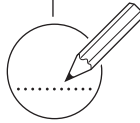
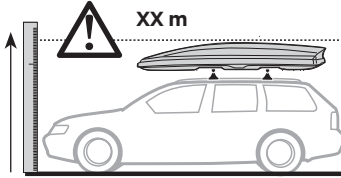
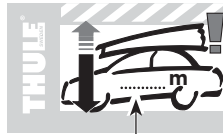

i

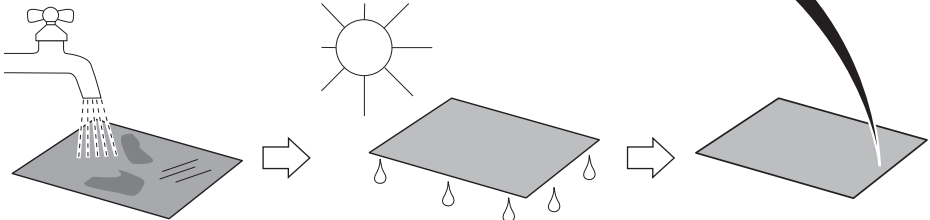
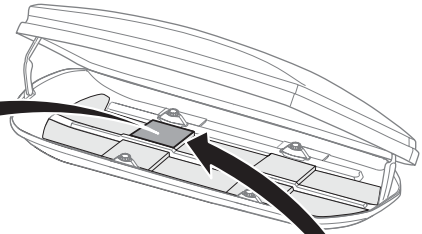

EN Accessories
DE Zubehör
FR Accessoires
NL Accessoires
IT Accessori
ES Accesorios
PT Acessórios
SV Tillbehör

DK Tilbehør
NE Tilbehør
FI Lisävarusteet
ET Lisavarustus
LV Piederumi
LT Priedai
PL Akcesoria
RU Аксессуары

UK Аксессуары
BG Принадлежности
CS Doploky
SK Príslušenstvo
SL Dodatki
HR/BIH Dodaci
RO Accesorii
HU Tartozékok

EL Εξαρτήματα
TR Aksesuarlar
AR الملحقات
HE אביזרים
ZH 附件
JA アクセサリー
KO 액세서리
TH อุปกรณ์เสริม

Thule Box Light

695100

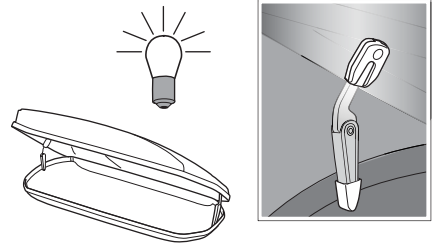
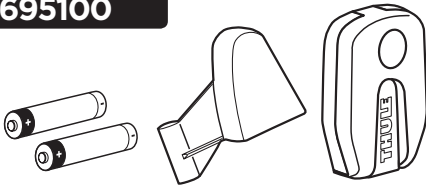

Thule Box Lid Cover

698100

➔ Dynamic 800/M

698300

➔ Dynamic 900/L

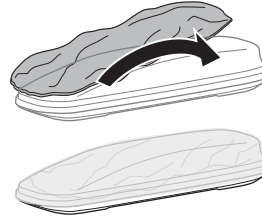

Thule T-track Adapter

696600

➔ 24x30 mm

697600

➔ 20x27 mm

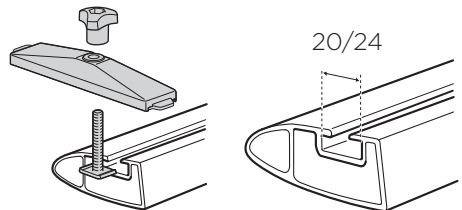

Thule Box Ski Carrier Adapter

694800

➔ Dynamic 800/M

694900

➔ Dynamic 900/L

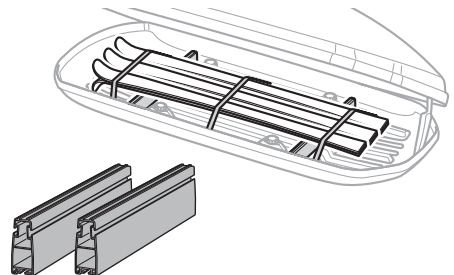

Thule MultiLift

572004

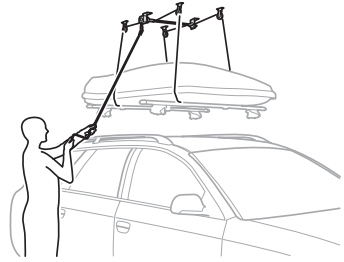
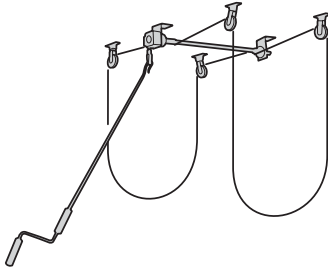

Thule One-Key System

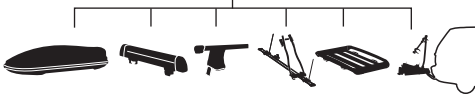

450400  (x4)

450600  (x6)

450800  (x8)

451200  (x12)

451600  (x16)

