



Thule XT Kit 3177

> Instructions

SUZUKI Across, 5-dr SUV, 21-

TOYOTA RAV4, 5-dr SUV, 19-

This kit is only for vehicles with fixpoint mounting.

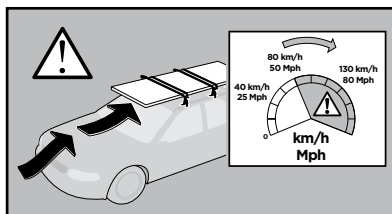
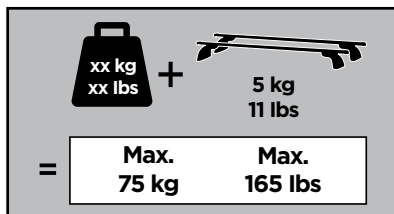
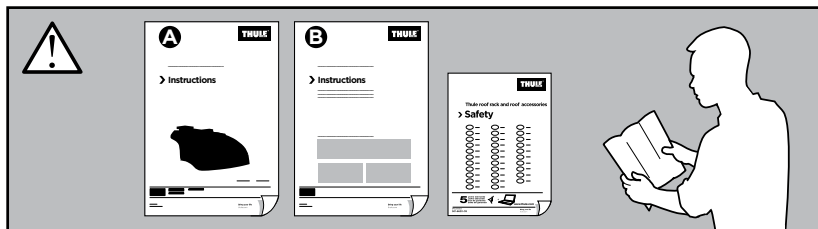

ISO 11154-E

183177
C.20210601
509-3177-03

Bring your life
thule.com

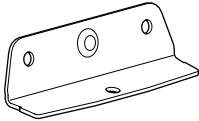

◀ 20 x4

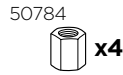

50784

x4

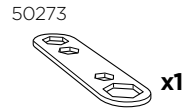

50273

x1

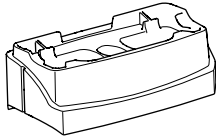

◀ 243 x2



31310

x4

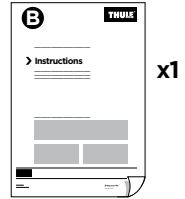

x1

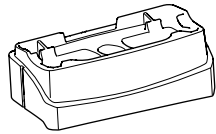

◀ 244 x1

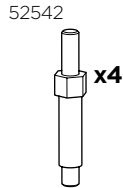

52542

x4

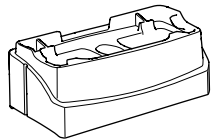

◀ 245 x1

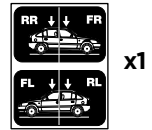

x1

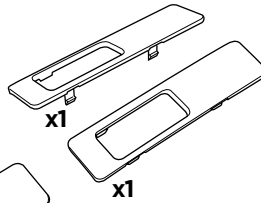

x1

x1

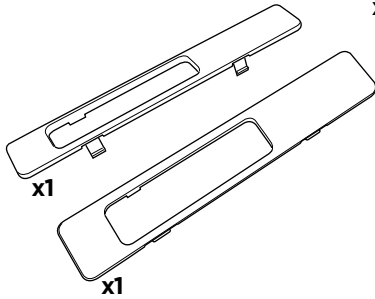

x1

x1

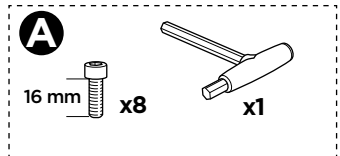

A

16 mm x8

x1

1

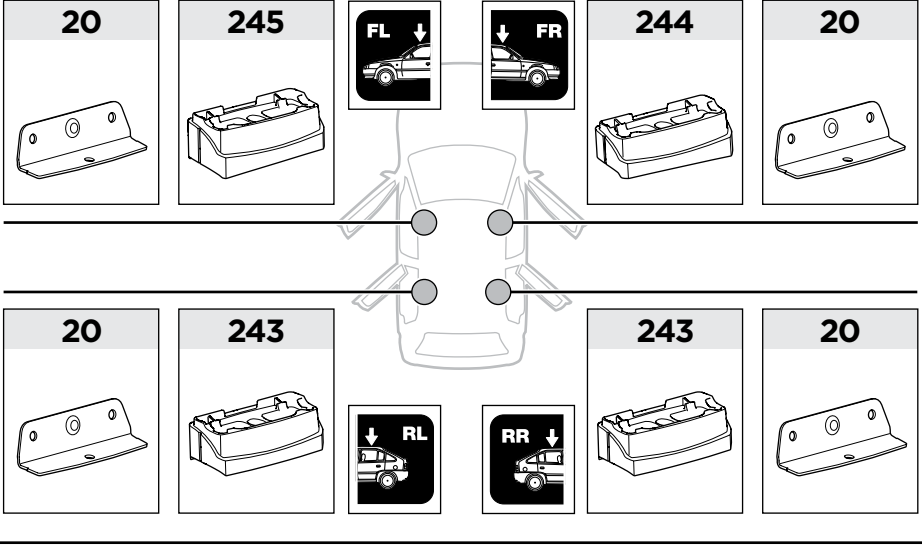

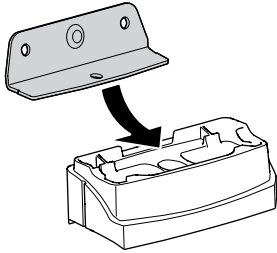
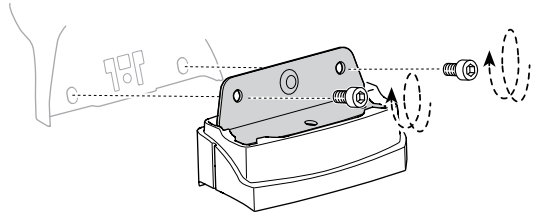
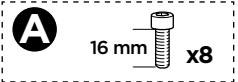
2**A****B**

EN Only a few turns
DE Nur wenige Umdrehungen
FR Quelques tours uniquement
NL Slechts enkele slagen
IT Solo qualche giro
ES Sólo algunas vueltas
PT Apenas algumas voltas
SV Endast några varv
DK Kun nogle få omgange
NO Bare noen få omdreininger
FI Vain muutama kierros

ET Ainult mõni pööre
LV Tikai daži apgriezieni
LT Tik keli pasukimai
PL Wystarczy kilka obrotów
RU Только несколько оборотов
UK Лише декілька обертів
BG Само няколко завъртания
CS Pouze několik otáček
SK Len niekoľko otáčok
SL Le nekaj obratov
HR/BIH Samo nekoliko okreta

RO Doar câteva rotiri
HU Csak néhány fordítás
EL Μόνο λίγες περιστροφές
TR Yalnızca birkaç tur

بعض دورات فقط **AR**

רק מספר סיבובים **HE**

ZH 仅几圈
JA 2 ~ 3 回転のみ
KO 몇 번만 돌리면 됨
TH เพียงสองสามรอบ

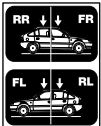
3

x1

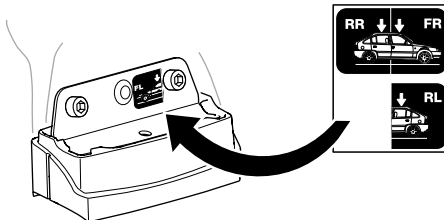

4

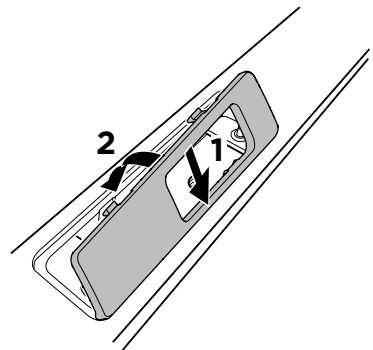
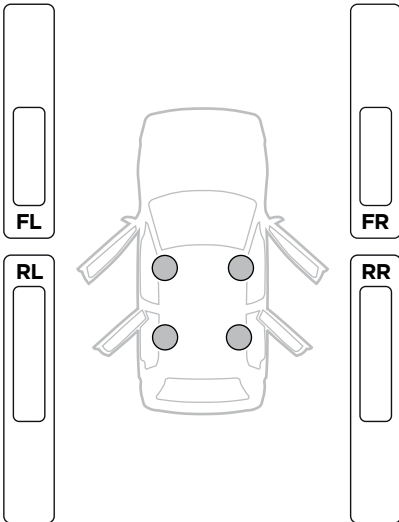
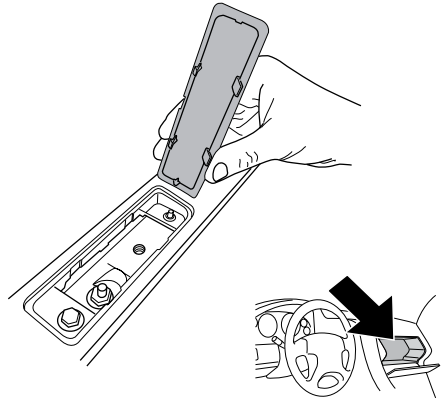
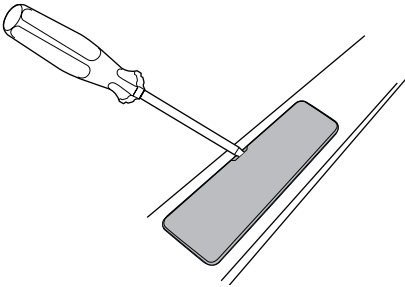
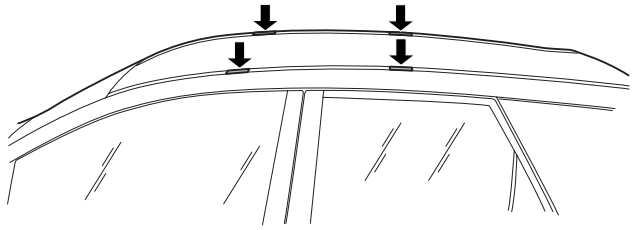

5

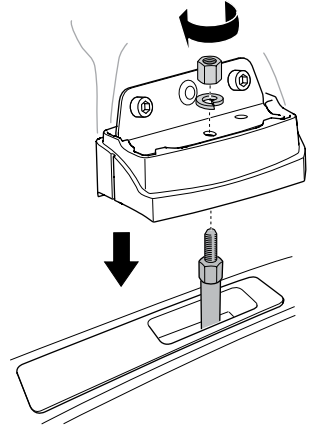
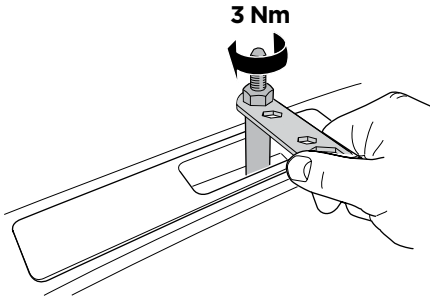
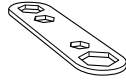

6

A

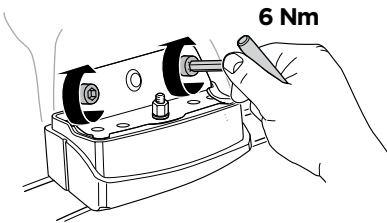
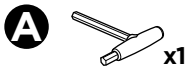

B

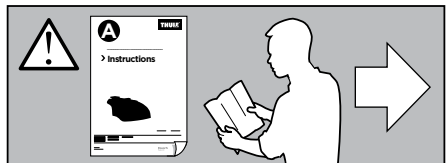
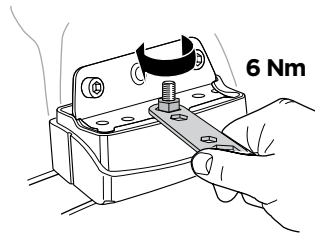
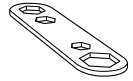



Thule Sweden AB, Borggatan 5, 335 73 Hillerstorp, SWEDEN
Thule Inc., 42 Silvermine Road, Seymour, Connecticut 06483, USA



info@thule.com
Phone: 800-238-2388



www.thule.com