



**1296-M020-0\_R**

**GTL2.120NRC**

INSTRUCTION MANUAL

**GB**

TRANSLATION FROM THE  
ORIGINAL INSTRUCTIONS

---

*For spare parts drawings refer to the section "LIST OF COMPONENTS" enclosed to this manual.*

---

- For any further information please contact your local dealer or call:

Technical services: **RAVAGLIOLI S.p.A.** - Via 1° Maggio, 3 - 40037 Pontecchio Marconi - Bologna Italy  
Phone (+39) 051 6781511 - Telex 510697 RAV I - Fax (+39) 051 846349 - e-mail: [aftersales@ravaglioli.com](mailto:aftersales@ravaglioli.com)

**1296-M020-0\_R - Rev. n. 0 (03/2020)**

**SUMMARY**

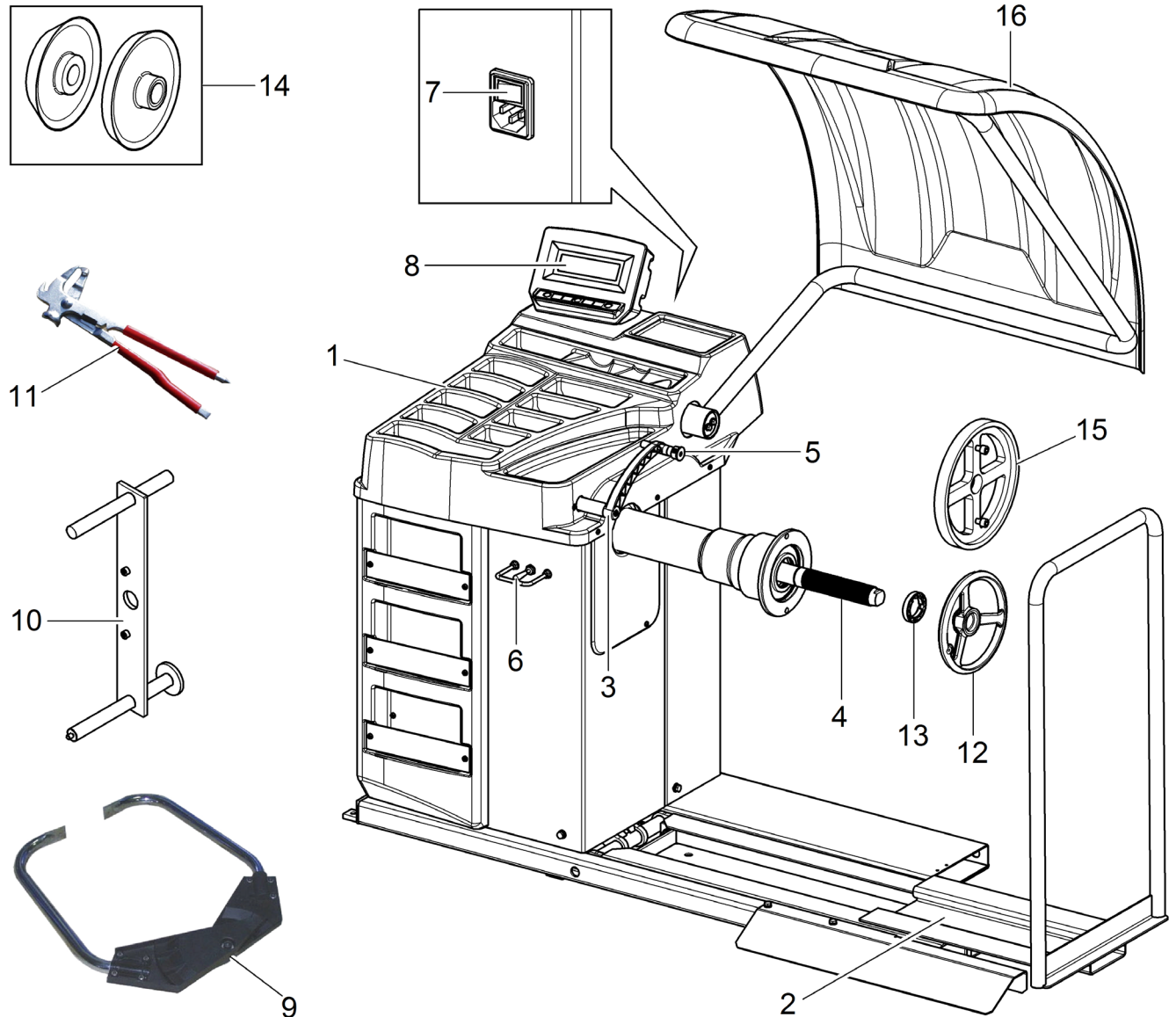
<b>GENERAL DESCRIPTION</b> _____	<b>4</b>	<b>15.0 WHEEL BALANCING</b> _____	<b>20</b>
<b>SYMBOLS USED IN THE MANUAL</b> _____	<b>5</b>	<b>15.1 Determination of wheel dimensions</b> _____	<b>20</b>
<b>INFORMATION PLATE LOCATION TABLE</b> _____	<b>6</b>	<b>15.1.1 Manual setting of wheel dimensions for dynamic static and balancing functions</b> _____	<b>20</b>
<b>1.0 GENERAL INTRODUCTION</b> _____	<b>8</b>	<b>15.2 User control function</b> _____	<b>22</b>
<b>1.1 Introduction</b> _____	<b>8</b>	<b>15.3 Unbalance measurement</b> _____	<b>23</b>
<b>2.0 INTENDED USE</b> _____	<b>8</b>	<b>15.3.1 Static balancing (STAT)</b> _____	<b>23</b>
<b>2.1 Training of personnel</b> _____	<b>8</b>	<b>15.3.2 Dynamic balancing</b> _____	<b>24</b>
<b>3.0 SAFETY DEVICES</b> _____	<b>9</b>	<b>15.3.3 Positioning the correction weights on the wheel</b> _____	<b>25</b>
<b>3.1 Residual risks</b> _____	<b>9</b>	<b>15.3.4 Wheel balancing with ALU-S program</b> _____	<b>26</b>
<b>4.0 GENERAL SAFETY RULES</b> _____	<b>9</b>	<b>15.4 Measuring the unbalance with auxiliary programs</b> _____	<b>28</b>
<b>5.0 PACKING AND MOBILIZATION FOR TRANSPORT</b> _____	<b>10</b>	<b>15.4.1 ALU-S1</b> _____	<b>28</b>
<b>6.0 UNPACKING</b> _____	<b>11</b>	<b>15.4.2 ALU-S2</b> _____	<b>28</b>
<b>7.0 MOBILIZATION</b> _____	<b>11</b>	<b>15.4.3 STATIC 1</b> _____	<b>28</b>
<b>8.0 WORKING ENVIRONMENT CONDITIONS</b> _____	<b>11</b>	<b>15.4.4 STATIC 2</b> _____	<b>29</b>
<b>8.1 Working area</b> _____	<b>12</b>	<b>15.4.5 ALU 1</b> _____	<b>29</b>
<b>8.2 Lighting</b> _____	<b>12</b>	<b>15.4.6 ALU 2</b> _____	<b>31</b>
<b>9.0 MACHINE ASSEMBLY</b> _____	<b>12</b>	<b>15.4.7 ALU 3</b> _____	<b>31</b>
<b>9.1 Anchoring system</b> _____	<b>12</b>	<b>15.4.8 ALU 4</b> _____	<b>31</b>
<b>9.2 Fixtures contained in the packing</b> _____	<b>13</b>	<b>15.4.9 PAX</b> _____	<b>31</b>
<b>9.3 Assembly procedures</b> _____	<b>13</b>	<b>15.5 Recalculation Function</b> _____	<b>32</b>
<b>9.3.1 Fitting the chuck on the flange</b> _____	<b>13</b>	<b>15.6 ECO-WEIGHT procedure</b> _____	<b>33</b>
<b>9.3.2 Mounting of foot guard protection</b> _____	<b>13</b>	<b>16.0 WHEEL BALANCING IN MOTORCYCLE MODE (WITH DISTANCE CALIPER EXTENSION KIT)</b> _____	<b>34</b>
<b>9.3.3 Fitting the protection guard (optional)</b> _____	<b>14</b>	<b>17.0 SPLIT PROCEDURE</b> _____	<b>34</b>
<b>10.0 ELECTRICAL CONNECTIONS</b> _____	<b>14</b>	<b>18.0 WEIGHTS HIDDEN BEHIND SPOKES MODE</b> _____	<b>37</b>
<b>10.1 Electrical checks</b> _____	<b>15</b>	<b>19.0 MATCHING PROCEDURE (Rim - Tyre Optimization)</b> _____	<b>39</b>
<b>11.0 AIR CONNECTION</b> _____	<b>15</b>	<b>20.0 SETUP OF MEASUREMENT, RESOLUTION, WIDTH MEASUREMENT OPTIONS AND SETTING TRUCK/MOTORCYCLE MODE</b> _____	<b>42</b>
<b>12.0 FITTING THE WHEEL ON THE CHUCK</b> _____	<b>16</b>	<b>20.1 Unit for measuring the weight and width/diameter of the rim</b> _____	<b>42</b>
<b>12.1 Wheel assembly</b> _____	<b>16</b>	<b>20.2 Setting preview result of static and eco-weight</b> _____	<b>43</b>
<b>12.2 Demounting of the wheel</b> _____	<b>17</b>	<b>20.3 Lower weight limit</b> _____	<b>44</b>
<b>13.0 DISPLAY WITH KEYBOARD</b> _____	<b>18</b>	<b>20.4 Setting adhesive weight dimensions and static threshold percentage</b> _____	<b>45</b>
<b>13.1 Brightness and contrast adjustment</b> _____	<b>18</b>	<b>21.0 CALIBRATION</b> _____	<b>46</b>
<b>14.0 SWITCHING THE MACHINE ON AND OFF</b> _____	<b>19</b>		



<b>21.1 Calibration in "CAR" or "MOTORCYCLE" mode</b> _____	<b>46</b>	<b>25.0 TECHNICAL DATA</b> _____	<b>54</b>
<b>21.2 Calibration in "TRUCK" mode</b> _____	<b>48</b>	<b>25.1 Technical electrical data</b> _____	<b>54</b>
<b>21.3 "Zero chuck" setting without anything</b> _____	<b>50</b>	<b>25.2 Technical mechanical data</b> _____	<b>54</b>
<b>22.0 DISPLAY MODE OF WEIGHTS</b>		<b>25.3 Dimensions</b> _____	<b>55</b>
<b>MEASUREMENT UNIT</b> _____	<b>50</b>	<b>26.0 STORING</b> _____	<b>56</b>
<b>22.1 Display of the weights in grams</b> _____	<b>50</b>	<b>27.0 SCRAPPING</b> _____	<b>56</b>
<b>22.2 Display of the weights in Ounces / grams</b> _____	<b>51</b>	<b>28.0 REGISTRATION PLATE DATA</b> _____	<b>56</b>
<b>23.0 ERROR SIGNALS</b> _____	<b>52</b>	<b>29.0 FUNCTIONAL DIAGRAMS</b> _____	<b>56</b>
<b>24.0 ROUTINE MAINTENANCE</b> _____	<b>53</b>	<i>Table A - Wiring connection diagram</i> _____	<b>57</b>
		<i>Table B - Pneumatic connection diagram</i> _____	<b>58</b>

**GENERAL DESCRIPTION**

**Fig. 1**














**KEY**

- 1 - Weight holding bridge
- 2 - Wheel lifting device
- 3 - Distance-diameter caliper
- 4 - Screw chuck
- 5 - Grippers for weight fitting
- 6 - Wheel lifting device control
- 7 - Main switch
- 8 - LCD display/control panel
- 9 - Trucks width gauge
- 10 - Trucks calibrator
- 11 - Grippers for weights
- 12 - Handwheel trucks ring nut
- 13 - Pressure ring
- 14 - 2 cones D. 202-221;281 trucks
- 15 - Flange for trucks wheels bearing
- 16 - Protection guard (optional)

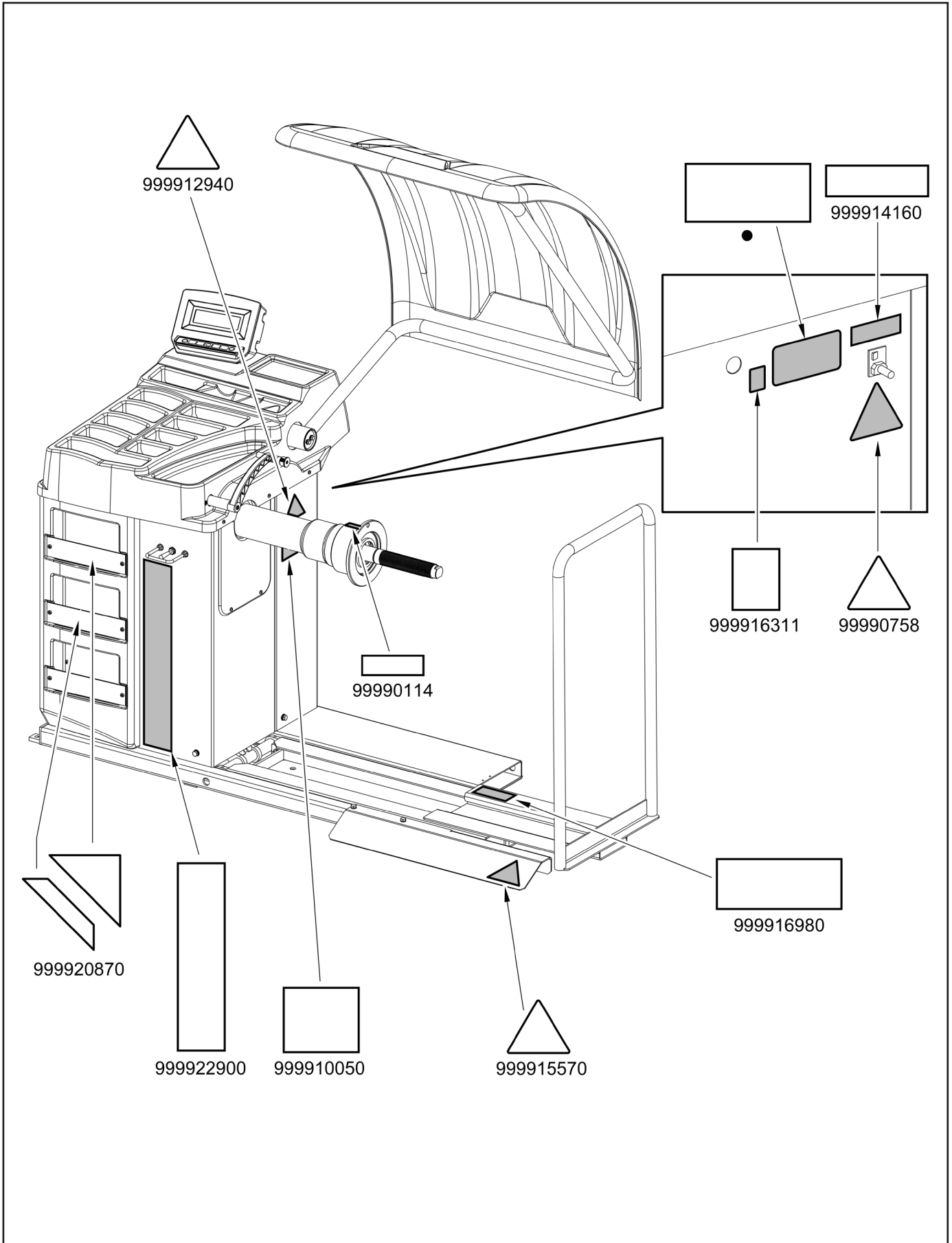


## SYMBOLS USED IN THE MANUAL

Symbols	Description
	Read instruction manual.
	Wear work gloves.
	Wear work shoes.
	Wear safety goggles.
	Mandatory. Operations or jobs to be performed compulsorily.
	Warning. Be particularly careful (possible material damages).

Symbols	Description
	Danger! Be particularly careful.
	Note. Indication and/or useful information.
	Move with fork lift truck or pallet truck.
	Lift from above.
	Attention: never lift the machine by means of the chuck.

**INFORMATION PLATE LOCATION TABLE**





GTL2.120NRC

## Code numbers of plates

<b>99990114</b>	<i>Arrow plate</i>
<b>99990758</b>	<i>Electricity danger plate</i>
<b>999910050</b>	<i>Protection device use plate</i>
<b>999912940</b>	<i>Lifting plate</i>
<b>999914160</b>	<i>230V 50/60 Hz 1 Ph voltage plate</i>
<b>999915570</b>	<i>Crushing danger plate</i>
<b>999916311</b>	<i>Skip plate</i>
<b>999916980</b>	<i>Capacity load 200 Kg plate</i>
<b>999920870</b>	<i>GT2_TRUCK plate</i>
<b>999922900</b>	<i>Manufacturer plate</i>
•	<i>Serial number plate</i>



**IF ONE OR MORE PLATES DISAPPEAR FROM THE MACHINE OR BECOMES DIFFICULT TO READ. REPLACE IT AND QUOTE ITS/THEIR CODE NUMBER/S WHEN REORDERING.**



**SOME OF THE PICTURES AND/OR DISPLAY SCREEN PAGES PRESENT IN THIS MANUAL HAVE BEEN OBTAINED FROM PICTURES OF PROTOTYPES, THEREFORE THE STANDARD PRODUCTION MACHINES AND ACCESSORIES CAN BE DIFFERENT IN SOME COMPONENTS/DISPLAY SCREEN PAGES.**

## 1.0 GENERAL INTRODUCTION

**This manual is an integral part of the product and must be retained for the whole operating life of the machine.**

Carefully study the warnings and instructions contained in this manual. It contains important instructions regarding **FUNCTIONING, SAFE USE and MAINTENANCE.**



**KEEP THE MANUAL IN A KNOWN, EASILY ACCESSIBLE PLACE FOR ALL ACCESSORY OPERATORS TO CONSULT IT WHENEVER IN DOUBT.**



**THE MANUFACTURER DISCLAIMS ALL RESPONSIBILITY FOR ANY DAMAGE OCCURRED WHEN THE INDICATIONS GIVEN IN THIS MANUAL ARE NOT RESPECTED: AS A MATTER OF FACT, THE NON-COMPLIANCE WITH SUCH INDICATIONS MIGHT LEAD TO EVEN SERIOUS DANGERS.**

### 1.1 Introduction

Thank you for preferring this wheel balancer. We feel sure you will not regret your decision.

This machine has been designed for use in professional workshops and stands out for its reliability and easy, safe and rapid operation. With just a small degree of maintenance and care, this wheel balancer will give you many years of trouble-free service and lots of satisfaction.

## 2.0 INTENDED USE

The machines described in this manual and their different versions, are wheels balancing machines for car, light transport and truck wheels, projected to be used exclusively to cancel out, or at least reduce to acceptable limits wheels' vibrations, by fitting counterweights, of suitable size and in specific positions to the same wheels that are not correctly balanced.



**DANGER: EMPLOYING THESE MACHINES OUTSIDE THE USE DESTINATION THEY HAVE BEEN DESIGNED FOR (AS INDICATED IN THIS MANUAL) IS INAPPROPRIATE AND DANGEROUS.**



**THE MANUFACTURER CANNOT BE HELD RESPONSIBLE FOR ANY DAMAGE CAUSED BY IMPROPER, ERRONEOUS, OR UNACCEPTABLE USE.**

### 2.1 Training of personnel

**The machine may be operated only by suitably trained and authorized personnel.**

Given the complexity of the operations necessary to manage the machine and to carry out the operations safely and efficiently, the personnel must be trained in such a way that they learn all the information necessary to operate the machine as intended by the manufacturer.



**A CAREFUL READING OF THIS INSTRUCTION MANUAL FOR USE AND MAINTENANCE AND A SHORT PERIOD OF TRAINING WITH SKILLED PERSONNEL CAN BE AN ENOUGH PREVENTIVE PREPARATION.**





### 3.0 SAFETY DEVICES



**PERIODICALLY, AT LEAST MONTHLY, CHECK THE INTEGRITY AND THE FUNCTIONALITY OF THE SAFETY AND PROTECTION DEVICES ON THE MACHINE.**


- **Master switch positioned on the rear of the machine**

Its function is to disconnect machine electric supply.

- **Protection guard (optional)**

Its function is to protect the operator from possible projections of materials on the wheel during its spin. Wheel spinning is normally prevented if the wheel protection guard is raised (open). When the protection guard is open, this interrupts the circuit that triggers the motor and automatic start is prevented, including in the case of an error.



Press  (F1) stop key to stop wheel rotation in emergency conditions.

#### 3.1 Residual risks

The machine was subjected to a complete analysis of risks according to reference standard EN ISO 12100. Risks are as reduced as possible in relation with technology and product functionality.

Possible residual risks have been emphasized through pictorial representations and warnings which placing is indicated in "PLATE POSITIONING TABLE" at page 6.

### 4.0 GENERAL SAFETY RULES



- Any tampering with or modification to the machine not previously authorized by the manufacturer exempts the latter from all responsibility for damage caused by or derived from said actions.
- Removing of or tampering with the safety devices or with the warning signals placed on the machine leads to serious dangers and represents a transgression of European safety rules.
- Use of the machine is only permitted in places free from **explosion** or **fire** hazard and in **dry places under cover**.
- Original spare parts and accessories should be used.



**THE MANUFACTURER DENIES ANY RESPONSIBILITY IN CASE OF DAMAGES CAUSED BY UNAUTHORIZED MODIFICATIONS OR BY THE USE OF NON ORIGINAL COMPONENTS OR EQUIPMENT.**

- Installation must be conducted only by qualified personnel exactly according to the instructions that are given below.
- Ensure that there are no dangerous situations during the machine operating manoeuvres. Immediately stop the machine if it miss-functions and contact the assistance service of an authorized dealer.
- In emergency situations and before carrying out any maintenance or repairs, disconnect all supplies to the machine by using the main switch, placed on the machine itself, and unplugging the power supply.
- The machine electrical supply system must be equipped with an appropriate earthing, to which the yellow-green machine protection wire must be connected.
- Ensure that the work area around the machine is free of potentially dangerous objects and that there is no oil since this could damage the tyre. Oil on the floor is also a potential danger for the operator.
- **UNDER NO CIRCUMSTANCES** must the machine be used to spin anything but vehicle wheels. Bad locking can cause rotating parts to come loose, with potential damage to the machine and anything in the vicinity and injury to the operator.



**OPERATORS MUST WEAR SUITABLE WORK CLOTHES, PROTECTIVE GLASSES AND GLOVES, AGAINST THE DANGER FROM THE SPRAYING OF DANGEROUS DUST, AND POSSIBLY LOWER BACK SUPPORTS FOR THE LIFTING OF HEAVY PARTS. DANGLING OBJECTS LIKE BRACELETS MUST NOT BE WORN, AND LONG HAIR MUST BE TIED UP. FOOTWEAR SHOULD BE ADEQUATE FOR THE TYPE OF OPERATIONS TO BE CARRIED OUT.**

- The machine handles and operating grips must be kept clean and free from oil.
- The workshop must be kept clean and dry. Make sure that the working premises are properly lit. The machine can be operated by a single operator. Unauthorized personnel must remain outside the working area, as shown in **Fig. 3**. Avoid any hazardous situations. Do not use air-operated or electrical equipment when the shop is damp or the floor slippery and do not expose such tools to atmospheric agents.
- When operating and servicing this machine, carefully follow all applicable safety and accident-prevention precautions. The machine must not be operated by untrained personnel.

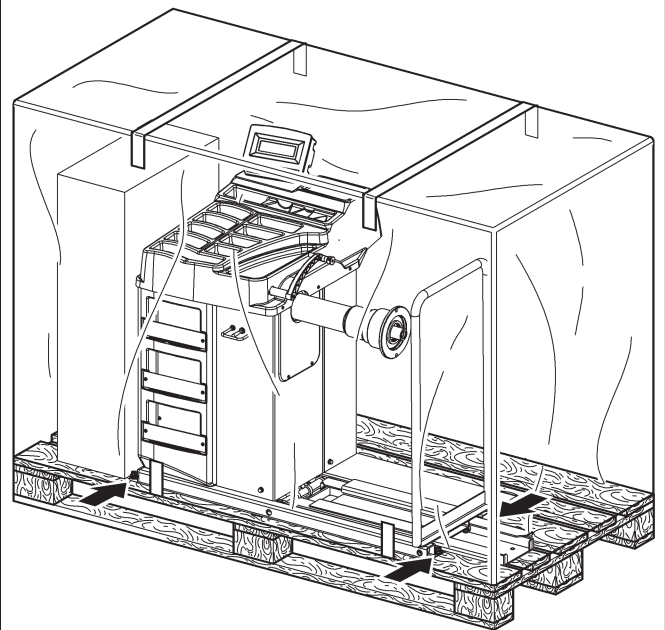
## 5.0 PACKING AND MOBILIZATION FOR TRANSPORT



**HAVE THE MACHINE HANDLED BY SKILLED PERSONNEL ONLY. THE LIFTING EQUIPMENT MUST WITHSTAND A MINIMUM RATED LOAD EQUAL TO THE WEIGHT OF THE PACKED MACHINE (SEE PARAGRAPH "TECHNICAL SPECIFICATIONS").**

The machine is packed partially assembled. Movement must be by pallet-lift or fork-lift trolley. The fork lifting points are indicated on the packing.

**Fig. 2**





## 6.0 UNPACKING



**DURING UNPACKING, ALWAYS WEAR GLOVES TO PREVENT ANY INJURY CAUSED BY CONTACT WITH PACKAGING MATERIAL (NAILS, ETC.).**



The cardboard box is supported with plastic strapping. Cut the strapping with suitable scissors. Use a small knife to cut along the lateral axis of the box and open it like a fan.

It is also possible to unnailed the cardboard box from the pallet it is fixed to. After removing the packing, and in the case of the machine packed fully assembled, check that the machine is complete and that there is no visible damage.

If in doubt **do not use the machine** and refer to professionally qualified personnel (to the seller).

The packing (plastic bags, expanded polystyrene, nails, screws, timber, etc.) should not be left within reach of children since it is potentially dangerous. These materials should be deposited in the relevant collection points if they are pollutants or non biodegradable.



**THE BOX CONTAINING THE FIXTURES IS CONTAINED IN THE WRAPPING. DO NOT THROW IT AWAY WITH THE PACKING.**

## 7.0 MOBILIZATION



**THE LIFTING EQUIPMENT MUST WITHSTAND A MINIMUM RATED LOAD EQUAL TO THE WEIGHT OF THE MACHINE (SEE PARAGRAPH TECHNICAL SPECIFICATIONS). DO NOT ALLOW THE LIFTED MACHINE TO SWING.**



**NEVER LIFT THE MACHINE BY MEANS OF THE CHUCK.**

If the machine has to be moved from its normal work post, the movement must be conducted following the instructions listed below.

- Protect the exposed corners with suitable material (Pluribol/cardboard).
- Do not use metallic cables for lifting.
- Make sure the electrical and pneumatic supply of the machine is not connected.
- Place again the machine onto the original pallet with whom it was delivered.
- Use transpallet or fork-lift for handling.

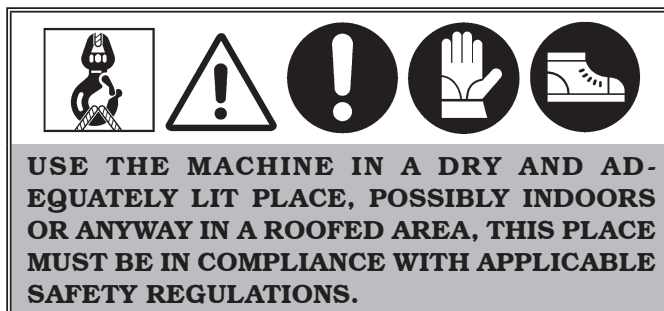
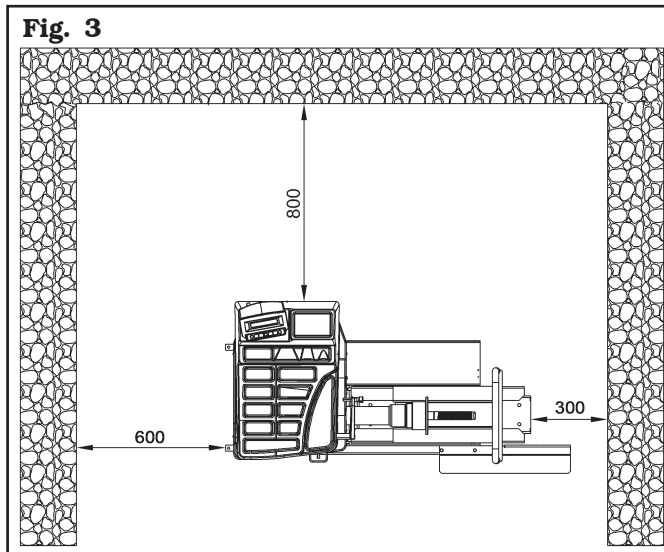
## 8.0 WORKING ENVIRONMENT CONDITIONS

The machine must be operated under proper conditions as follows:

- temperature: 0° + 45° C
- relative humidity: 30 - 90% (dew-free)
- atmospheric pressure: 860 - 1060 hPa (mbar).

The use of the machine in ambient conditions other than those specified above is only allowed after prior agreement with and approval of the manufacturer.

### 8.1 Working area



The location of the machine requires a usable space as indicated in **Fig. 3**. The positioning of the machine must be according to the distances shown. From the control position the operator is able to observe all the machine and surrounding area. He must prevent unauthorized personnel or objects that could be dangerous from entering the area. The machine must be fixed on a flat floor surface, preferably of cement or tiled. Avoid yielding or irregular surfaces.

The base floor must be able to support the loads transmitted during operation.

This surface must have a capacity load of at least 500 kg/m<sup>2</sup>.

The depth of the solid floor must be sufficient to guarantee that the anchoring bolts hold.

### 8.2 Lighting

The machine does not require its own lighting for normal working operations. However, it must be used in an adequately lit environment.

In case of poor lighting use lamps having total power of 800/1200 Watt.

### 9.0 MACHINE ASSEMBLY



**EACH MECHANICAL INTERVENTION MUST BE CARRIED OUT BY PROFESSIONALLY QUALIFIED STAFF.**

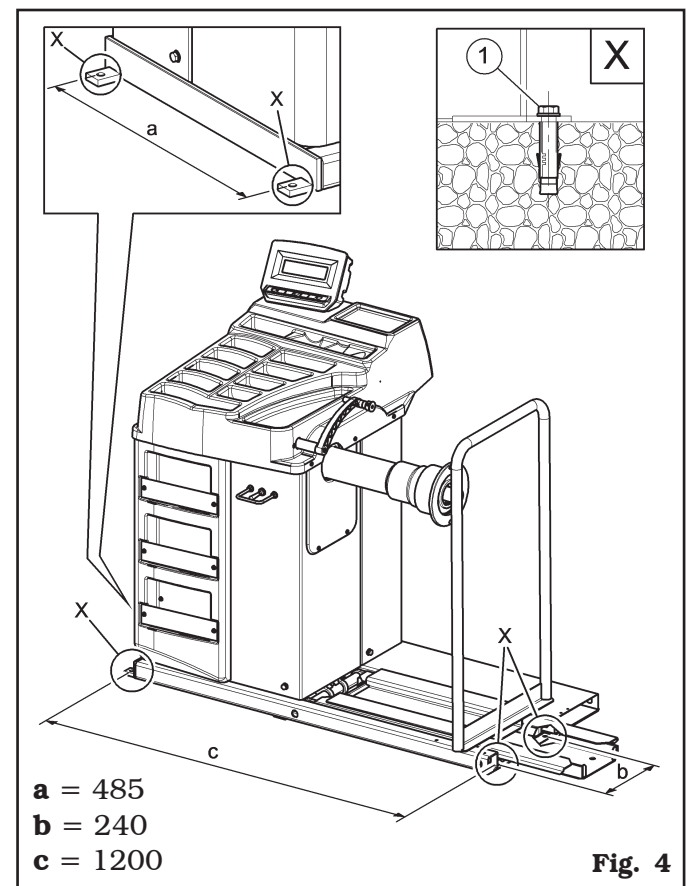
After having freed the various components from the packing check that they are complete, and that there are no anomalies, then comply with the following instructions for the assembly of the components making use of the attached series of illustrations.

#### 9.1 Anchoring system

The packed machine is fixed to the support pallet through the holes prearranged on the frame. Such holes can be used also to fix the machine to the ground, through floor anchor small blocks (excluded from supply). Before carrying out the definitive fixing, check that all the anchor points are laid down flat and correctly in contact with the fixing surface itself. If not so, insert shimming profiles between the machine and the fixing lower surface, as indicated in **Fig. 4**.



**IN CASE OF WHEEL WEIGHING MORE THAN 30 KG, IT IS COMPULSORY TO FIX TO THE GROUND BY MEANS OF SCREW ANCHORS.**

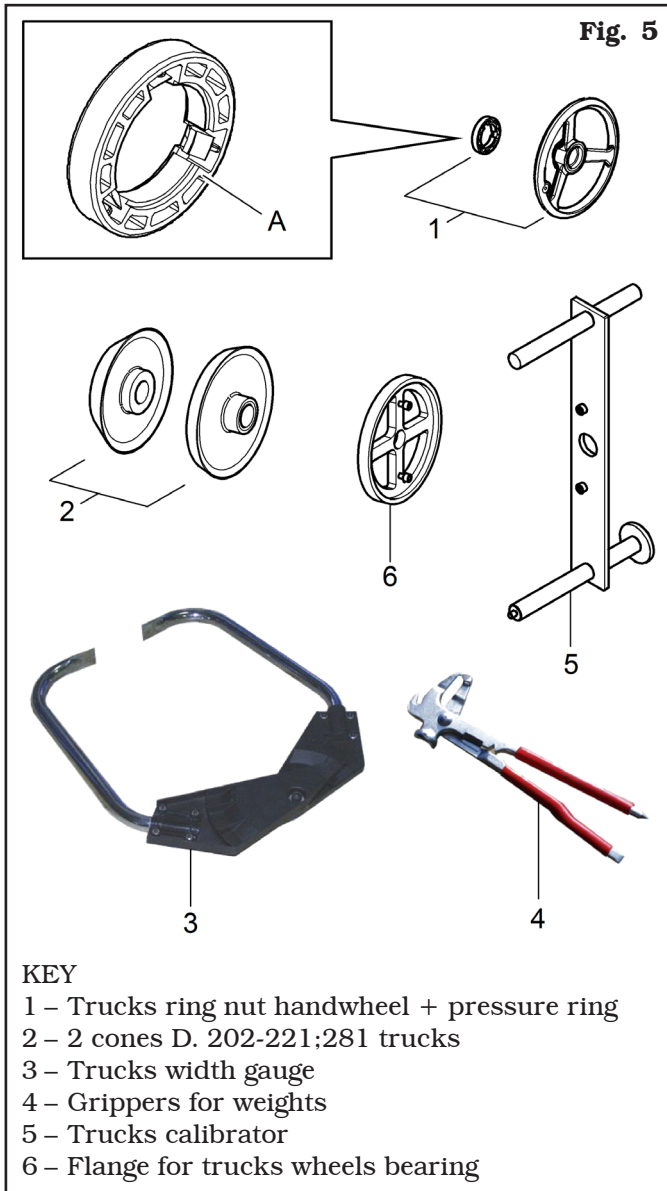


**Fig. 4**

- Execute 4 holes with 10 mm diameter on the floor by the holes on the bottom floor;
- insert the small blocks (excluded from supply) into the holes;
- fix the machine to the ground with 4 M8x80 mm screws (excluded from supply) (**Fig. 4 ref. 1**) (or with 4 8x80 mm stud bolts (excluded from supply)). Tighten the screws with an approximate tightening torque of 70 Nm.

## 9.2 Fixtures contained in the packing

The packing case contains also the fixtures box. Check that all the parts listed below are there (see **Fig. 5**).

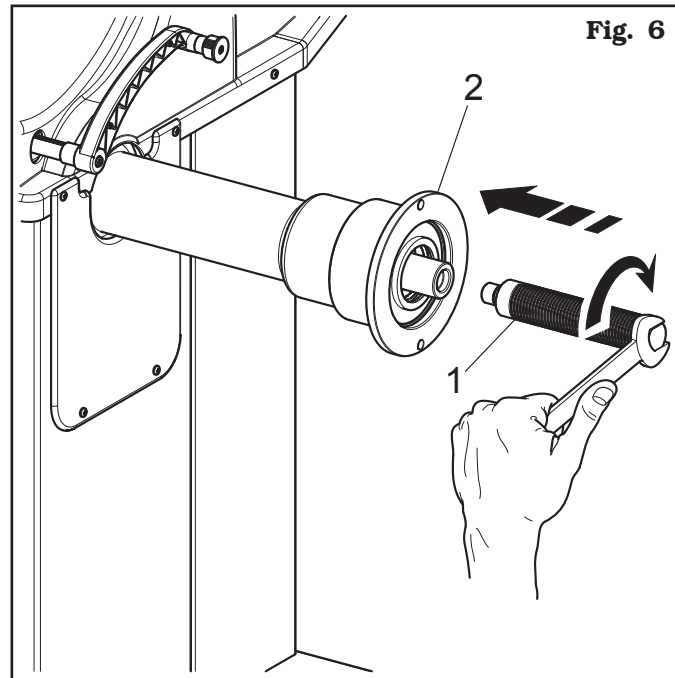


**THE PRESSURE RING (FIG. 5 REF. A) MUST BE MOUNTED WITH THE TEETH OR DISCHARGE SIDE TOWARDS THE RING-NUT (SEE FIG. 5).**

## 9.3 Assembly procedures

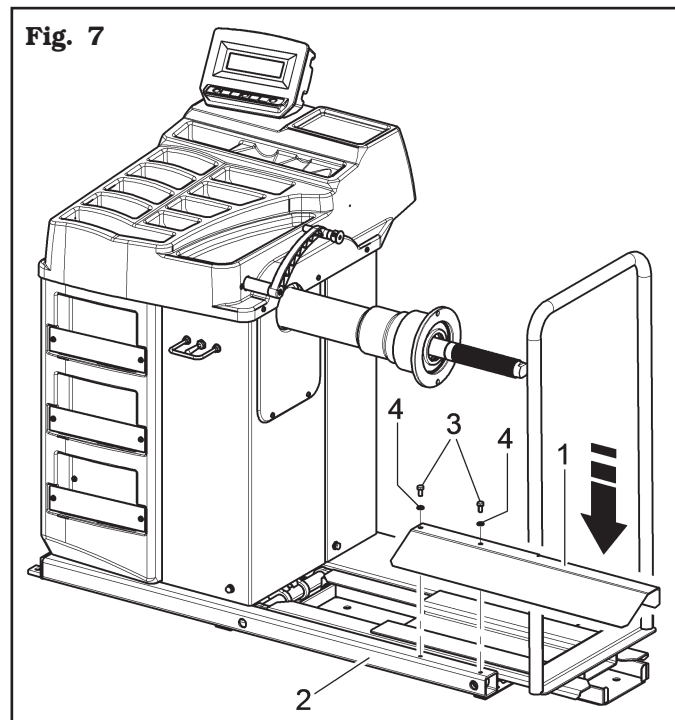
### 9.3.1 Fitting the chuck on the flange

Screw the chuck with an Allen wrench (**Fig. 6 ref. 1**) on the flange (**Fig. 6 ref. 2**).



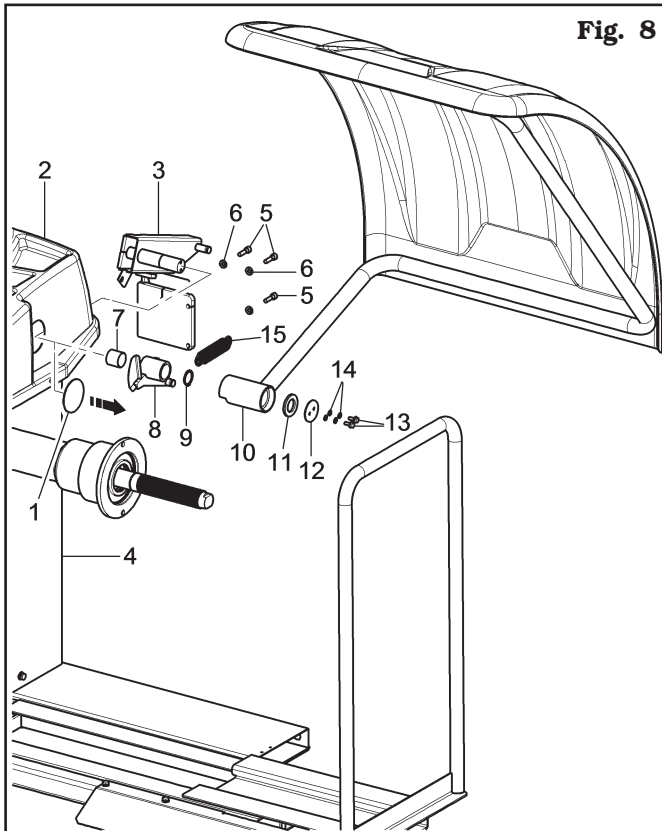
### 9.3.2 Mounting of foot guard protection

Fasten the foot guard protection (**Fig. 7 ref. 1**) at the base of the lift (**Fig. 7 ref. 2**) using the screws (**Fig. 7 ref. 3**) and the washers (**Fig. 7 ref. 4**) supplied.



### **9.3.3 Fitting the protection guard (optional)**

1. Remove the pre-sheared cap (**Fig. 8 ref. 1**) from the prearranged hole on the bridge (**Fig. 8 ref. 2**).
2. Mount the equalizer's support (**Fig. 8 ref. 3**) to the support (**Fig. 8 ref. 4**) with the screws (**Fig. 8 ref. 5**) and the washers (**Fig. 8 ref. 6**) supplied.
3. Mount in order the ferrule (**Fig. 8 ref. 7**), the equalizer (**Fig. 8 ref. 8**), the seeger (**Fig. 8 ref. 9**) and the wheel cover unit (**Fig. 8 ref. 10**).  
Fit the washer (**Fig. 8 ref. 11**) and lock all the elements with the cap (**Fig. 8 ref. 12**) screwing the screws (**Fig. 8 ref. 13**) and the washers (**Fig. 8 ref. 14**), supplied.
4. At the end fit the spring (**Fig. 8 ref. 15**) to the equalizer support pin (**Fig. 8 ref. 3**) and to the equalizer pin (**Fig. 8 ref. 8**).



**Fig. 8**

## **10.0 ELECTRICAL CONNECTIONS**



**EVEN THE TINIEST PROCEDURE OF AN ELECTRICAL NATURE MUST BE CARRIED OUT BY PROFESSIONALLY QUALIFIED STAFF.**



**BEFORE CONNECTING THE MACHINE MAKE SURE THAT:**

- **THE MAIN POWER RATING CORRESPONDS TO THE MACHINE RATING AS SHOWN ON THE MACHINE PLATE;**
- **ALL MAIN POWER COMPONENTS ARE IN GOOD CONDITION;**
- **THE ELECTRICAL SYSTEM IS PROPERLY GROUNDED (GROUND WIRE MUST BE THE SAME CROSS-SECTION AREA AS THE LARGEST POWER SUPPLY CABLES OR GREATER);**
- **MAKE SURE THAT THE ELECTRICAL SYSTEM FEATURES A CUTOUT WITH DIFFERENTIAL PROTECTION SET AT 30 mA.**

Connect the machine up to the mains by means of the 3-pole plug provided (230 V 1-phase).

If the plug provided is not suitable for the wall socket, fit a plug that complies with local and applicable regulations. This operation must be performed by expert and professional personnel.



**FIT A TYPE-APPROVED (AS REPORTED BEFORE) PLUG TO THE MACHINE CABLE (THE GROUND WIRE IS YELLOW/GREEN AND MUST NEVER BE CONNECTED TO ONE OF THE TWO PHASE LEADS).**



**MAKE SURE THAT THE ELECTRICAL SYSTEM IS COMPATIBLE WITH THE RATED POWER ABSORPTION SPECIFIED IN THIS MANUAL AND APT TO ENSURE THAT VOLTAGE DROP UNDER FULL LOAD WILL NOT EXCEED 4% OF RATED VOLTAGE (10% UPON START-UP).**



**FAILURE TO OBSERVE THE ABOVE INSTRUCTIONS WILL IMMEDIATELY INVALIDATE THE WARRANTY.**

### 10.1 Electrical checks



**BEFORE STARTING UP THE WHEEL-BALANCER, BE SURE TO BECOME FAMILIAR WITH THE LOCATION AND OPERATION OF ALL CONTROLS AND CHECK THEIR PROPER OPERATION (SEE PAR. "CONTROLS").**



**CARRY OUT A DAILY CHECK OF MAINTAINED-TYPE CONTROLS CORRECT FUNCTIONING, BEFORE STARTING MACHINE OPERATION.**

Once the plug/socket connection has been made, turn on the machine using the master switch (**Fig. 9 ref. 1**).

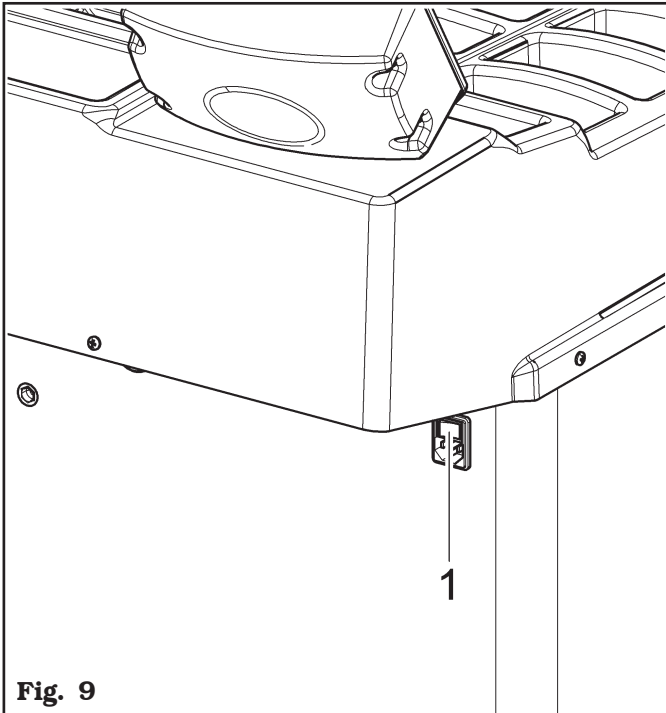


Fig. 9

### 11.0 AIR CONNECTION



**EACH PNEUMATIC INTERVENTION MUST BE CARRIED OUT BY PROFESSIONALLY QUALIFIED STAFF.**

Connect the wheel balancer to the centralised compressed-air system by means of the connection on the back of the machine (see **Fig. 10 ref. 1**).

The air system supplying the machine must be able to supply filtered and de-humidified air at a pressure between 8 and 10 bar. It must feature an on-off valve upstream of the machine.

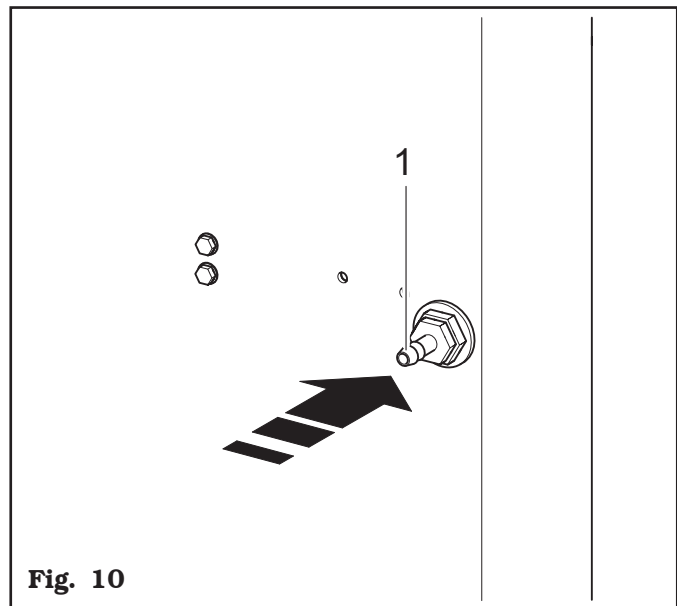


Fig. 10

## 12.0 FITTING THE WHEEL ON THE CHUCK



To achieve perfect balancing, the wheel must be carefully and properly fitted on the chuck. Imperfect centring will inevitably cause unbalances.



**WHAT IS MOST IMPORTANT IS THAT ORIGINAL CONES AND ACCESSORIES, SPECIALLY DESIGNED TO BE EMPLOYED WITH THE WHEEL BALANCERS, ARE USED.**

Wheel fitting using the cones provided is illustrated below. For alternative fittings, using optional accessories, refer to the special instructions provided separately.

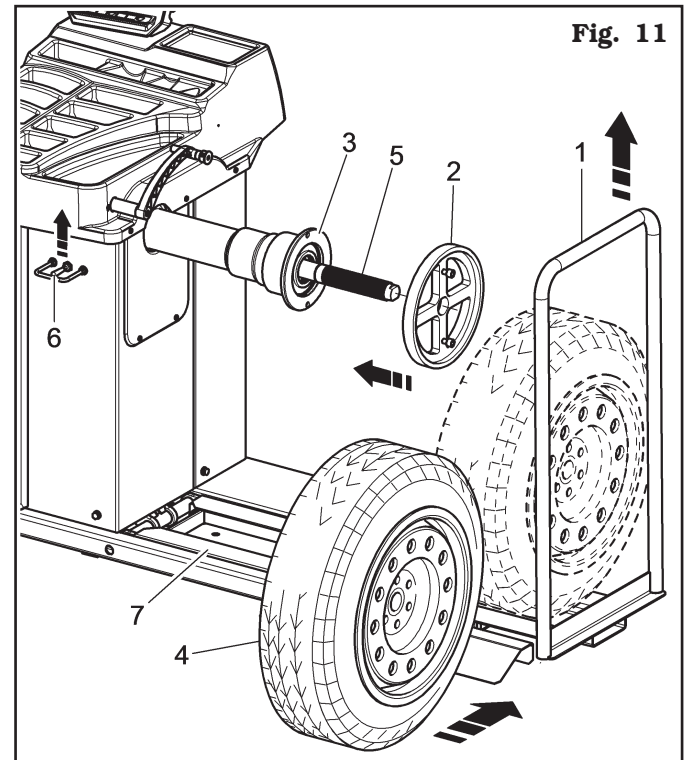
### 12.1 Wheel assembly

1. Move rightwards the wheel support (**Fig. 11 ref. 1**). Fit the adapter flange (**Fig. 11 ref. 2**) on the chuck flange (**Fig. 11 ref. 3**).
2. Remove any type of foreign body from the wheel (**Fig. 11 ref. 4**): pre-existing weights, stones and mud, and make sure the chuck (**Fig. 11 ref. 5**) and the rim centring area are clean before fitting the wheel on the chuck.
3. Place the wheel (**Fig. 11 ref. 4**) on the wheel support (**Fig. 11 ref. 1**) with the rim inner side towards the wheel balancer. Operate the lifting device control (**Fig. 11 ref. 6**) and, keeping it lifted, lift the footboard (**Fig. 11 ref. 7**) and centre manually the wheel on the chuck, with a minimum strain independently from its weight.



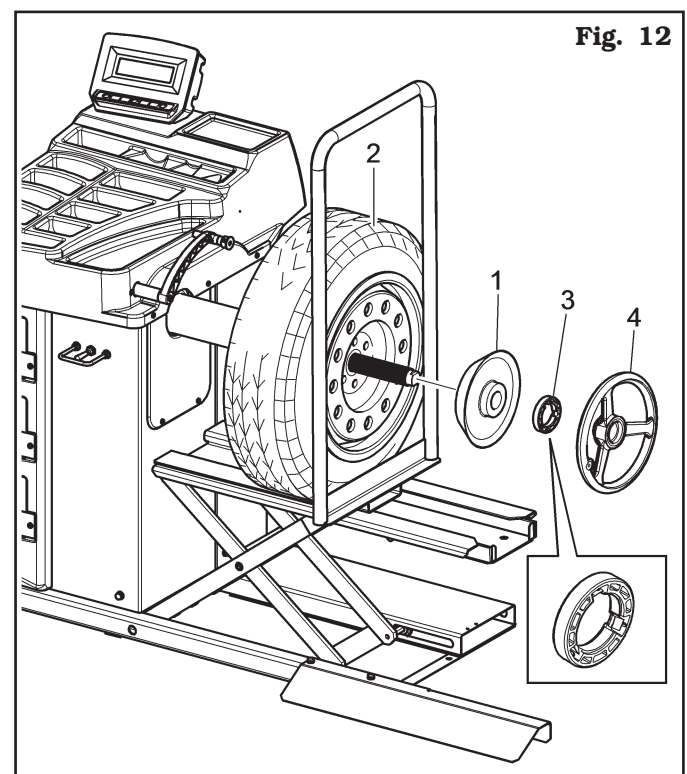
**ONCE THE WISHED HEIGHT HAS BEEN REACHED, RELEASE THE LIFTING DEVICE CONTROL.**

4. Move the wheel support leftwards (**Fig. 11 ref. 1**).



**Fig. 11**

5. Fit the cone (**Fig. 12 ref. 1**) against the wheel (**Fig. 12 ref. 2**) to be balanced. Fit the cone (**Fig. 12 ref. 1**) with the narrowest part against the wheel. These accessories must be selected according to the shape of the rim.
6. Fit the pressure ring (**Fig. 12 ref. 3**) in the hand-wheel nut (**Fig. 12 ref. 4**) and fasten everything against the cone (**Fig. 12 ref. 1**).



**Fig. 12**





**THE PRESSURE RING (FIG. 12 REF. 3) MUST BE MOUNTED WITH THE TEETH OR DISCHARGE SIDE TOWARDS THE RING-NUT (FIG. 12 REF. 4).**

7. Lower the lifting device control (Fig. 13 ref. 1) and then lower the footboard (Fig. 13 ref. 2).

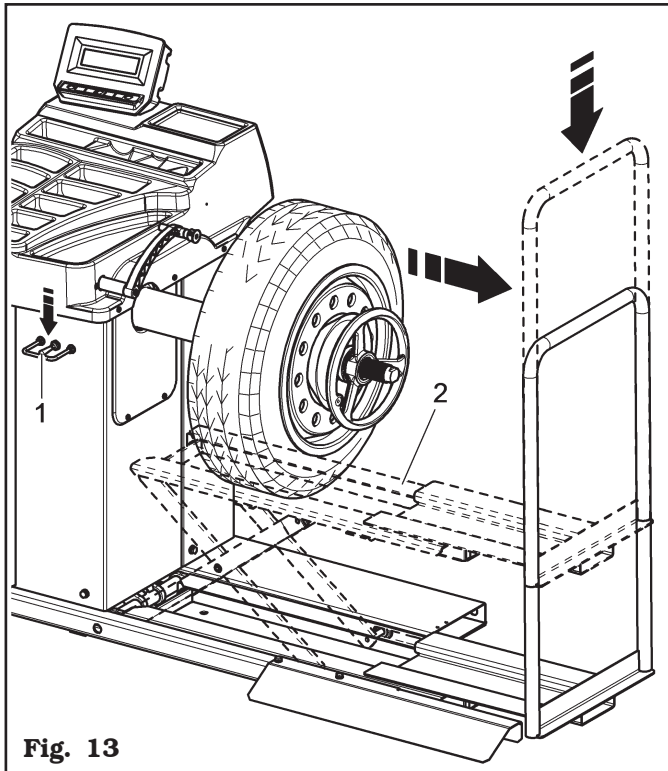


Fig. 13

### 12.2 Demounting of the wheel

1. Move leftwards the wheel support (Fig. 14 ref. 1) and bring the wheel support plane (Fig. 14 ref. 5) under the tyre (Fig. 14 ref. 2).
2. Lift the lifting device control (Fig. 14 ref. 3) and lift the footboard (Fig. 14 ref. 4) until the wheel bearing (Fig. 14 ref. 5) comes in contact with the tyre (Fig. 14 ref. 2).



**ONCE THE WISHED HEIGHT HAS BEEN REACHED, RELEASE THE LIFTING DEVICE CONTROL.**

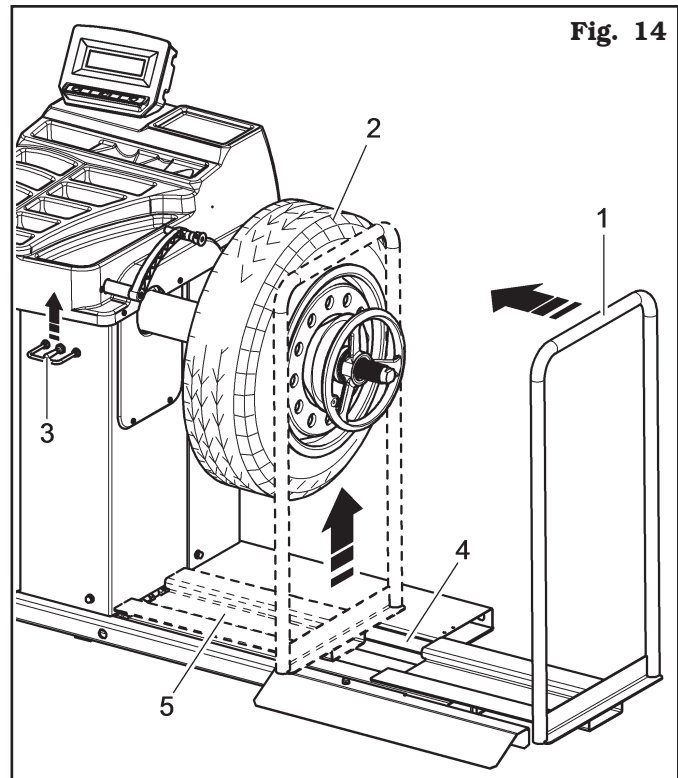


Fig. 14

3. Unlock the wheel (Fig. 15 ref. 1) engaged to the chuck, removing the locking devices (Fig. 15 ref. 2).
4. Move rightwards the wheel support (Fig. 15 ref. 3) together with the tyre that is leaning against it.
5. Lower the lowering device control (Fig. 15 ref. 4) and then lower the footboard (Fig. 15 ref. 5).

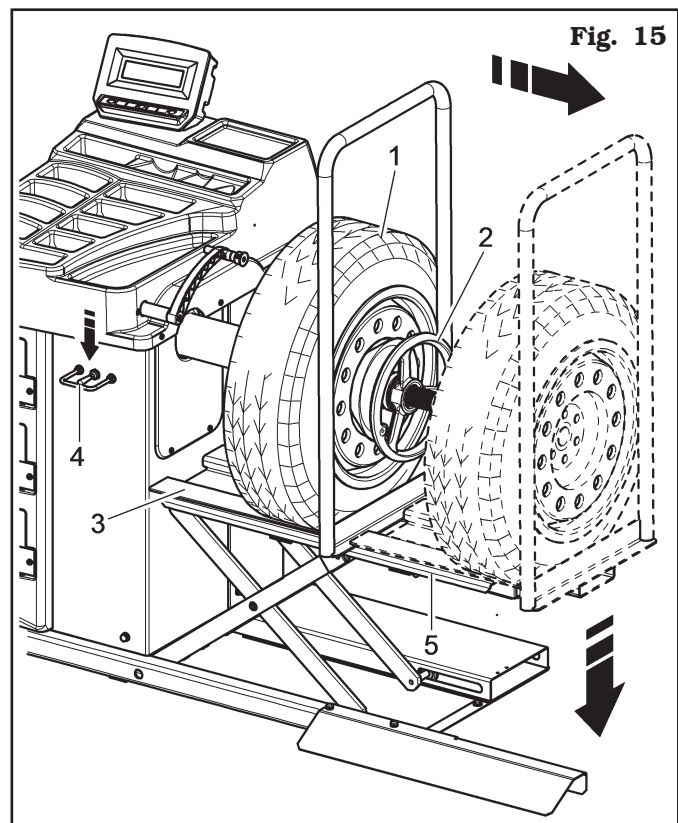


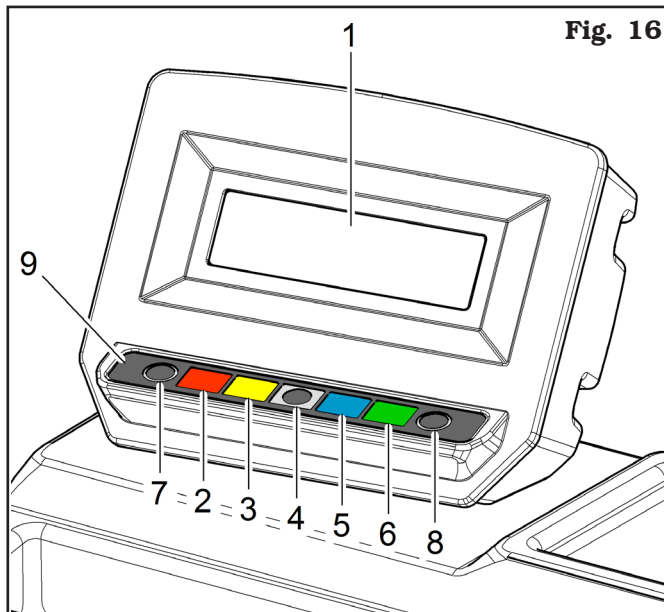
Fig. 15

6. Remove the wheel from the lifting device.

### 13.0 DISPLAY WITH KEYBOARD

The wheel balancers are equipped with a multifunction LCD display, equipped with a keyboard to interact/operate the controls present in graphical form on the same display.

On such display are displayed all the instructions for the correct wheel balancing, for example indicating where the operator shall fit adhesive or clip weights and the balancing mode and/or option used, as well as correct wheel rotation for inner/outer weights positioning.



**Fig. 16**

**KEY**

- 1 - Display
- 2 - Function push button (red)
- 3 - Function push button (yellow)
- 4 - Function push button (grey)
- 5 - Function push button (blue)
- 6 - Function push button (green)
- 7 - Previous page push button
- 8 - Next page push button
- 9 - Push button panel (keyboard with 7 keys)

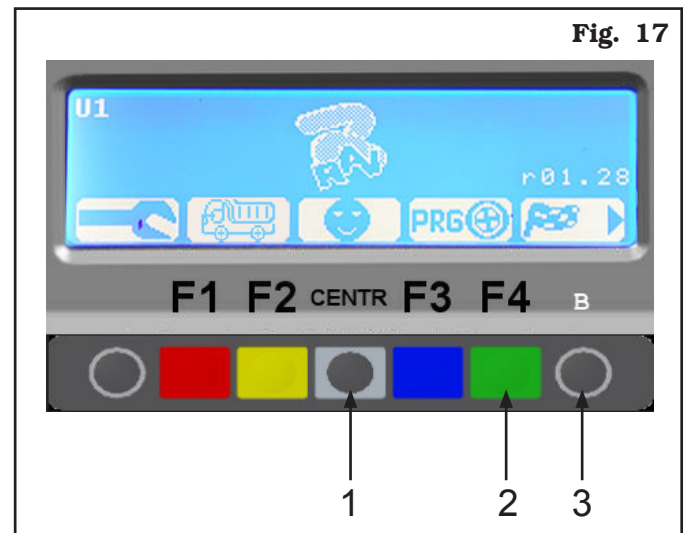
### 13.1 Brightness and contrast adjustment

From the first page of the program, by keeping the push button (**B**) (**Fig. 17 ref. 3**) pressed, push push button (**F4**) (**Fig. 17 ref. 2**) repeatedly in order to raise brightness/contrast or push push button (**CENTR**) (**Fig. 17 ref. 1**) repeatedly in order to lower brightness/contrast.

Try to find the best settings, going across the all steps, because the settings can pass through clear, dark and again clear.



**THE ADJUSTMENT REMAINS ALSO AFTER MACHINE SHUT-DOWN.**



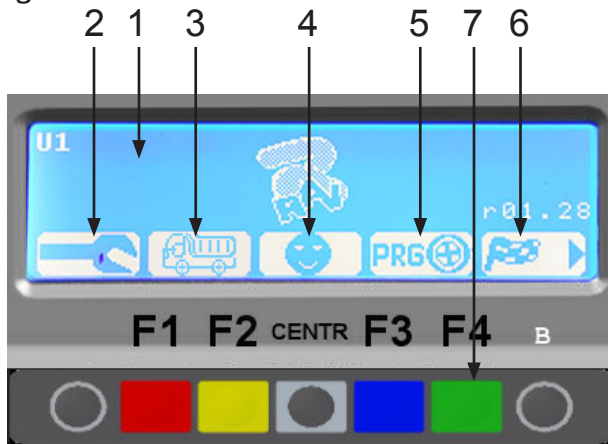
**Fig. 17**

## 14.0 SWITCHING THE MACHINE ON AND OFF




The ON/OFF master switch is located on the rear of the machine. To start the machine and access the program, switch on the system by turning the master switch. Wait a few seconds for the operating program to load and for the first program page to appear on the display screen (see **Fig. 18**).

The monitor shows various types of information and presents the user with numerous operation options.

**Fig. 18**



### KEY

- 1 – Start page
- 2 – Display of program configuration screen play (RED) (F1)
- 3 – Display of truck , car  or motorcycle  mode (YELLOW) (F2)
- 4 – Display of the tests of the different users (4 different users are managed) (Par. 15.2) (CENTRAL)
- 5 – Display of auxiliary programs modes (Par. 15.4) (BLUE) (F3)
- 6 – The balancing test starts (GREEN) (F4)
- 7 – Program operation key

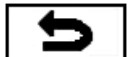
By means of the 6 keys of the operating keyboard (F1-F2-CENTR-F3-F4-B) all the machine functions can be used.

During program running, the various display pages show the different keys by means of which the corresponding function can be immediately selected.

Many display pages contain several rows of keys. In this case, the next row of keys can be displayed by


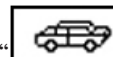

means of the key corresponding to the icon .


To go back and display the previous row of keys, press

the key corresponding to the icon  or in some


cases .

By pressing the “F2” key, the measurement mode can be changed from car to truck and vice versa.

The symbol “” which appears on the screen on the first page indicates that the machine is in TRUCK mode; the symbol “” on the other hand indicates CAR mode and the symbol “” indicates MOTORCYCLE mode.

Using the “TRUCK” mode  wheels can be balanced with a max static or dynamic unbalance of 1990 g (there is an automatic scale change from 990 g to 1990 g).


The indicated resolution is 50 g, however by pressing

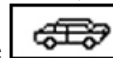
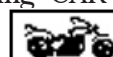
“CENTR” key  the unbalance can be CENTR with a max resolution of 10 g.




**FOR UNBALANCES FROM 40 G TO 100 G THE RESOLUTION IS ALWAYS 10 G; FOR UNBALANCES BELOW 40 G THIS IS NORMALLY INDICATED AS 0 G, HOWEVER BY**

**PRESSING THE KEY  THE UNBALANCE IS DISPLAYED WITH MAX RESOLUTION OF 10 G.**


In “TRUCK” mode , “MATCHING” procedure cannot be performed (Rim-tyre optimization) nor can ALL AUXILIARY functions (see Par. 15.4) be selected.

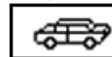
By using “CAR” mode  and “MOTORCYCLE” mode  wheels can be balanced with a max static or dynamic unbalance of 300g.

The indicated resolution is 5 g, however by pressing

“CENTR” key  the unbalance can be CENTR with a max resolution of 1 g.

In “CAR” mode  and “MOTORCYCLE” mode

 “MATCHING” procedure (Rim-tyre optimization; see Chapt. 19), SPLIT (see Chap. 17) and WEIGHTS HIDDEN BEHIND SPOKES MODE (see Chapt. 18) procedure can be performed.

ALL AUXILIARY functions (see Par. 15.4) can also be selected in “CAR” mode  only.

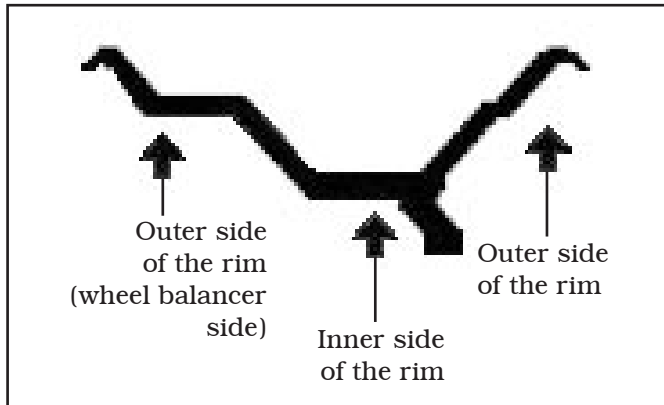


**IN ORDER TO FIT SPECIAL WHEELS ON THE BALANCER SHAFT, THE SPECIFIC CONES, FLANGES AND RING NUT WILL BE REQUIRED SUPPLIED SEPARATELY AS ACCESSORIES.**

## 15.0 WHEEL BALANCING



### Symbols on display



### 15.1 Determination of wheel dimensions

#### 15.1.1 Manual setting of wheel dimensions for dynamic static and balancing functions


- To make a measurement in **STATIC** mode:

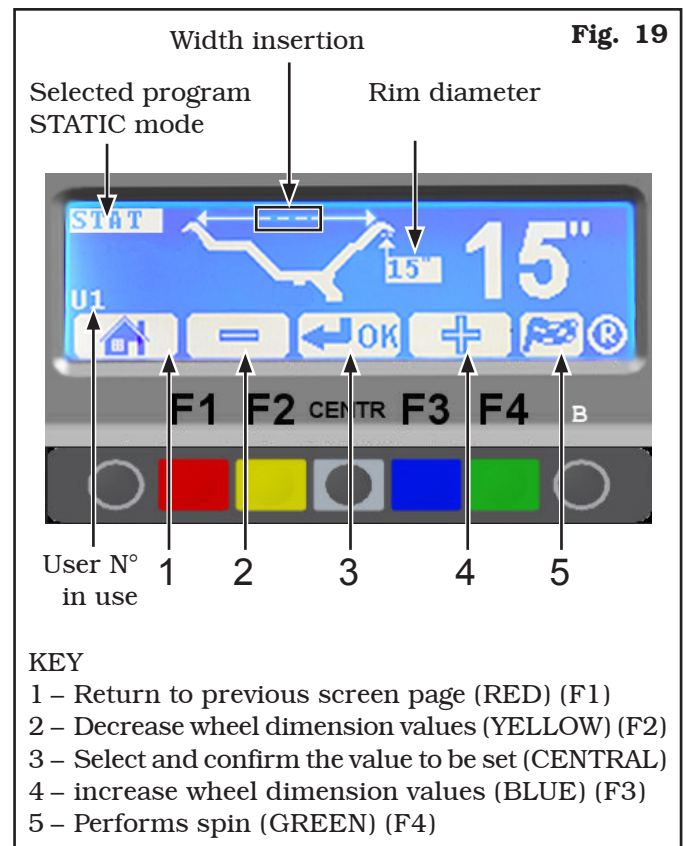
**Valid for truck/car/motorcycle**

Wheel balancers feature a manual caliper and a graduated scale for determining wheel dimensions (**Fig. 20** and **Fig. 22**).

The dimension of the rim distance is always set with measurement unit "mm".

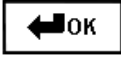
The width and diameter values on the other hand can be set in "inches" or "mm"; in the examples in this manual "inches" are used. To change the unit of measurement from "inches" to "mm", see Chap. 20.

Press "F3" , the program goes directly from the start screen page (**Fig. 18**) to the screen page illustrated below (STATIC mode, **Fig. 19**).



**KEY**

- 1 - Return to previous screen page (RED) (F1)
- 2 - Decrease wheel dimension values (YELLOW) (F2)
- 3 - Select and confirm the value to be set (CENTRAL)
- 4 - increase wheel dimension values (BLUE) (F3)
- 5 - Performs spin (GREEN) (F4)

Press the "CENTRAL" key  to select the value to set (only diameter) (**Fig. 19 ref. 3**).

The display screen will show the selected value on white bright background and on the right the same value in large characters. Increase or decrease

the measurements through the keys  or



. Press the "CENTRAL" key  and

execute the spin by pressing "F4" key  (**Fig. 19 ref. 5**).

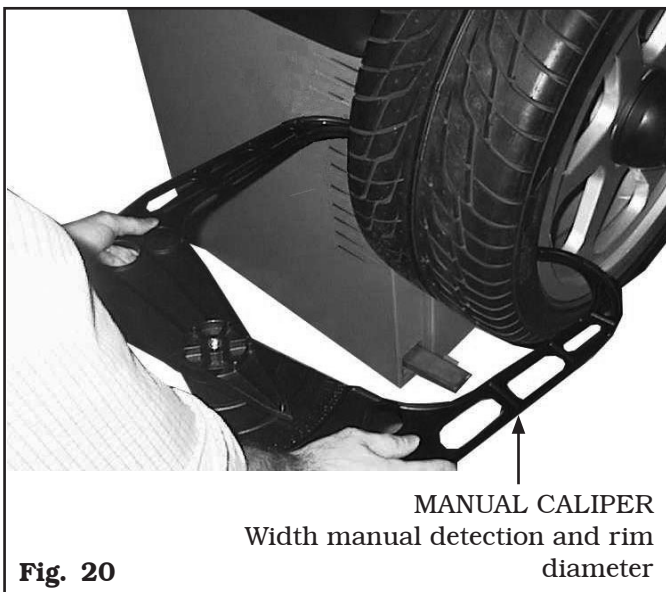
• To make a measurement in **DYNAMIC** mode:

**Valid for truck/car/motorcycle**

Enter the wheel width manually.

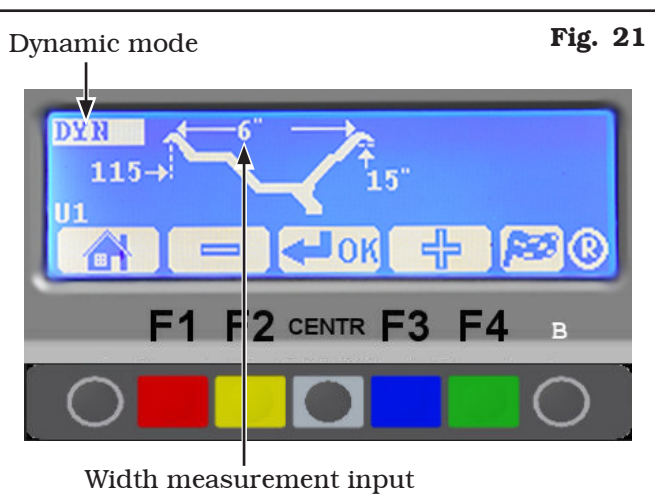
The operator must press “LESS”  or “MORE”  keys until the desired value is reached (**Fig. 21**).

Input the nominal width shown on the rim, or manually check by using the graduated caliper, positioning it on the outer and inner side of the wheel as shown in **Fig. 20**.

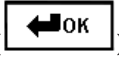


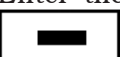
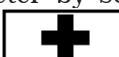
**Fig. 20**



Once wheel width has been input, the program prepares for dynamic mode measuring (**Fig. 21**).



**Fig. 21**

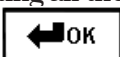
Press the centre key () to select the rim diameter dimension.

Enter the rim diameter by selecting the “PLUS”  or “MINUS”  key until the desired value is achieved.

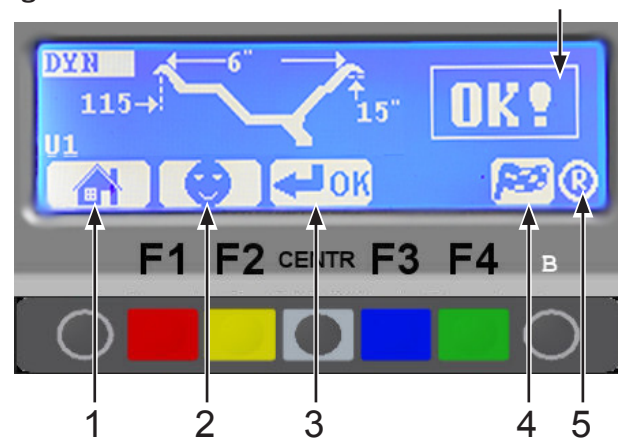
The width (see **Fig. 22**) is stored by selecting the “MINUS”  or “PLUS”  key until the value read on the graduated scale is achieved.



**Fig. 22**

After setting all the wheel dimensions, press the centre key () again to confirm. The program will show the screen page in **Fig. 23**.

**Fig. 23** Dimensions entered and confirmed



**KEY**



- 1 – Return to previous screen page (RED) (F1)
- 2 – User Control (Par. 15.2) (YELLOW) (F2)
- 3 – Select and confirm the value to be set (CENTRAL)
- 4 – Performs spin (GREEN) (F4)
- 5 – Function key used for recalculation program (Par. 15.5) (B)

- **To make a measurement in ALU-S mode and auxiliary programs:**



**Valid for truck/car/motorcycle**

Select the ALU-S function as described in Par. 15.4 and press the "CENTRE key" to confirm and enter the measurements.

Move the graduated scale to the position where the inner weight is to be fitted. Read the value to be set on the scale. Enter the distance by selecting the "PLUS"



 or "MINUS"  key until the desired value is achieved.

Press the "CENTRE key" to confirm.

Enter the wheel diameter (by selecting the "MINUS"  or "PLUS"  key until the desired value is achieved.

Press the "CENTRE key" to confirm.

The program will show the screen page in **Fig. 24**. Move the graduated scale to the position where the outer weight is to be fitted (always hidden inside the rim). Read the value to be set on the scale.

Enter the distance by selecting the "PLUS"  or "MINUS"  key until the desired value is achieved. Press the "CENTRE key" to confirm.

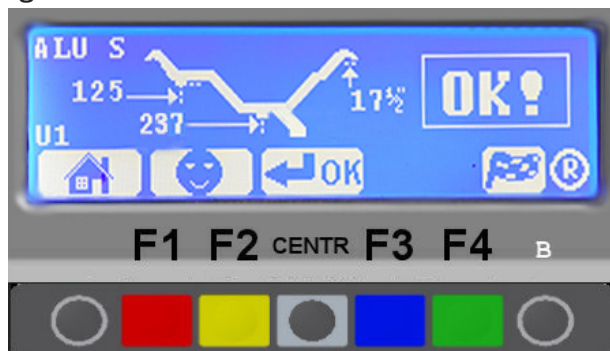
**Fig. 24**



To display all the entered measurements, press a few times "CENTR key".

Press the "F4 key" to start spin.

**Fig. 25**



**15.2 User control function**

To select user management, select the following key on the presentation page.



Wheel balancers can be used by 4 different users at the same time, by selecting the above indicated key several times, until the desired user is reached.

When the user key is pressed, the current user number appears on the display screen (T1, T2, T3, T4 in truck mode, U1, U2, U3 and U4 in car mode or M1, M2, M3 and M4 in motorcycle mode).

The system stores the data relating to the last performed spin according to the different operators. The desired user can be called every time the program displays the specific key. The measurements stored for each user are lost when the machine is switched off. User management is valid for any wheel balancer function.



**TO ENABLE OR DISABLE "USER CONTROL" FUNCTION, SEE CHAP. 20 (FIG. 72). ONCE THIS FUNCTION HAS BEEN DISENGAGED, BY PRESSING "USER KEY F3" ON THE PRESENTATION PAGE, THE ONLY CURRENT USER "T" (IN TRUCK MODE) APPEARS ON THE TOP LEFT OF THE MONITOR, "U" INDICATES CAR MODE, WHILE "M" INDICATES MOTORCYCLE MODE.**

## 15.3 Unbalance measurement

### 15.3.1 Static balancing (STAT)

#### Valid for truck/car/motorcycle


STATIC balancing is a procedure that offsets wheel vibrations using a single adhesive weight on a single plane. Press the "CENTRE key" to confirm. Enter the measurements (Par. 15.1) and proceed following the instructions below.




Make sure there are no stones and/or mud on the wheel.

Remove any counterweights.

Fit the wheel and make sure it is properly fastened (see Chapt. 12).

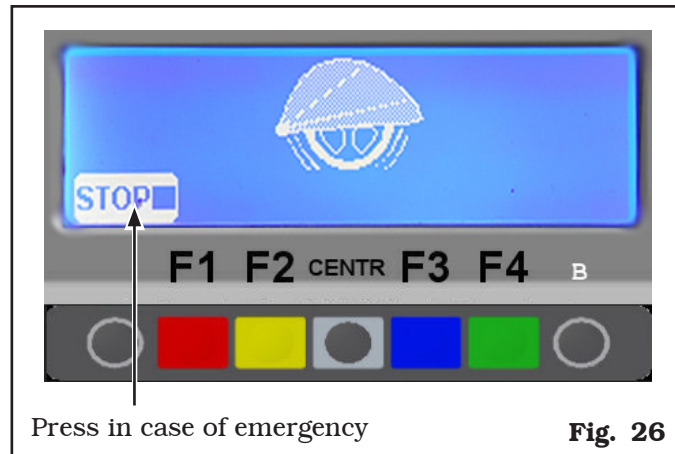
Press the "F3 key"  from the initial program page (see Chap. 14).

Enter the wheel measurements (Par. 15.1), close the

protection guard (if any) and press "F4 key"  to perform the spin.

In just a few seconds, the wheel runs at normal speed and the wheel balancer display shows wheel rotation (Fig. 26). Do not touch the wheel while taking measurements. At the end of the spin, the wheel will stop automatically, taking into account the measured unbalance so the outer weight fitting position is at approx. "12 o'clock".

Open the protection guard (if present).



Press in case of emergency

Fig. 26

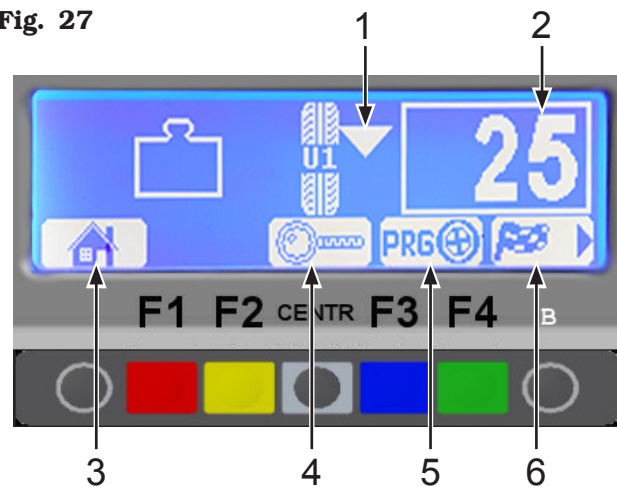
The display unit indicates the direction in which to move the wheel to fit the weight and how much weight is needed to correct the unbalance (see Fig. 27).

Turn the wheel at the point indicated by the arrows, until the correct position has been reached to correct

the unbalance (.

Once the unbalance value of the wheel side is known, the wheel can be positioned properly.

Fig. 27



#### KEY

- 1 - Turn the wheel in the direction shown by the arrows until correct position of the wheel itself is reached for the weight fitting
- 2 - Total outer weight to be fitted
- 3 - Return to initial program phase (RED) (F1)
- 4 - Displays exact unbalance (resolution 1 g instead of 5 g) (CENTRAL)
- 5 - Display of auxiliary programs modes (Par. 14.4) (BLUE) (F3)
- 6 - Performs wheel spin (GREEN) (F4)  
(if carter is missing)  
Spin performed on closing guard  
(if carter option is enabled)

Fit the adhesive weight in the measurement gauge as shown in **Fig. 28**., using a weight of pre-determined value (the example in **Fig. 27** shows 25 g).



**Fig. 28**

Fit the adhesive weight on the outside of the wheel, approximately in the centre of the wheel (see **Fig. 29**). The position of the outer weight is not visible but hidden inside.



**Fig. 29**

Check wheel balancing conditions by making a trial spin. The display screen will show an unbalance reset. The STATIC procedure is completed.


### **15.3.2 Dynamic balancing**

#### **Valid for truck/car/motorcycle**

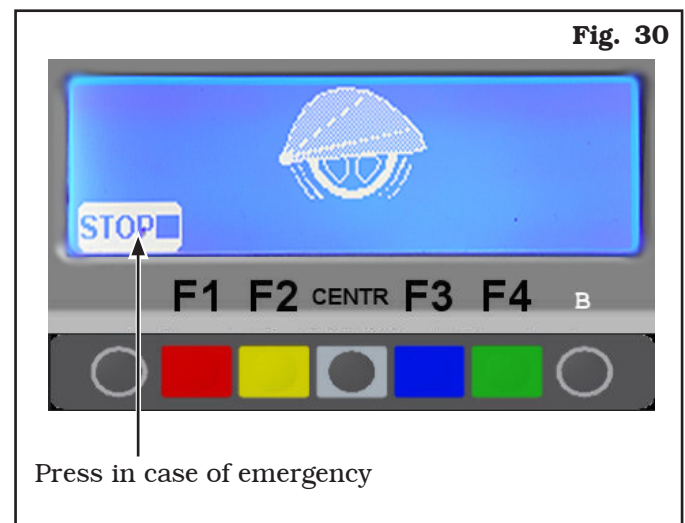
Dynamic balancing is a procedure that offsets the wheel vibrations using 2 weights on different planes. To perform a dynamic balancing spin:

- make sure there are no stones and/or mud on the wheel.
- Remove any counterweights.
- Fit the wheel and make sure it is fastened properly.

Press the "F3 key"  from the initial program page (see Chap. 14).

Enter the wheel measurements (Par. 15.1), close the protection guard (if any) , and press "F4 key"  to perform the spin.

In just a few seconds, the wheel runs at normal speed and the wheel balancer display shows wheel rotation (**Fig. 30**). After the spin, the wheel stops automatically, also taking into account the measured unbalance so that the fitting position of the outer weight is **exactly at "12 o' clock"**. Open the protection guard (if present).



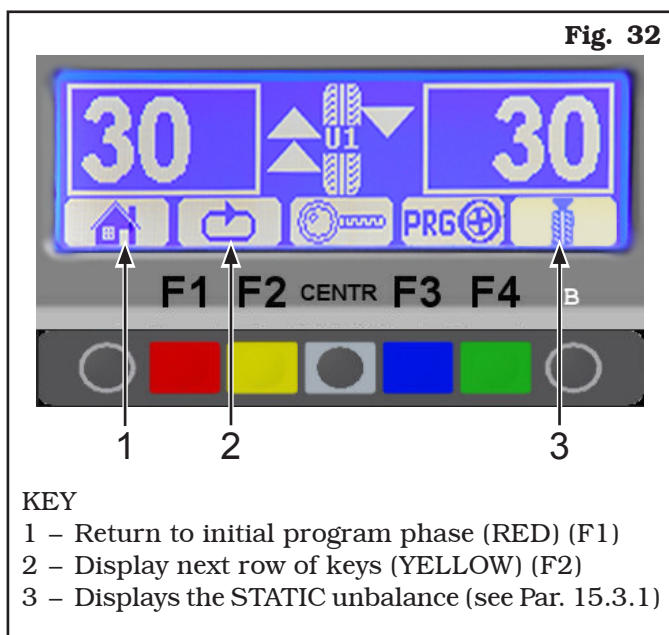
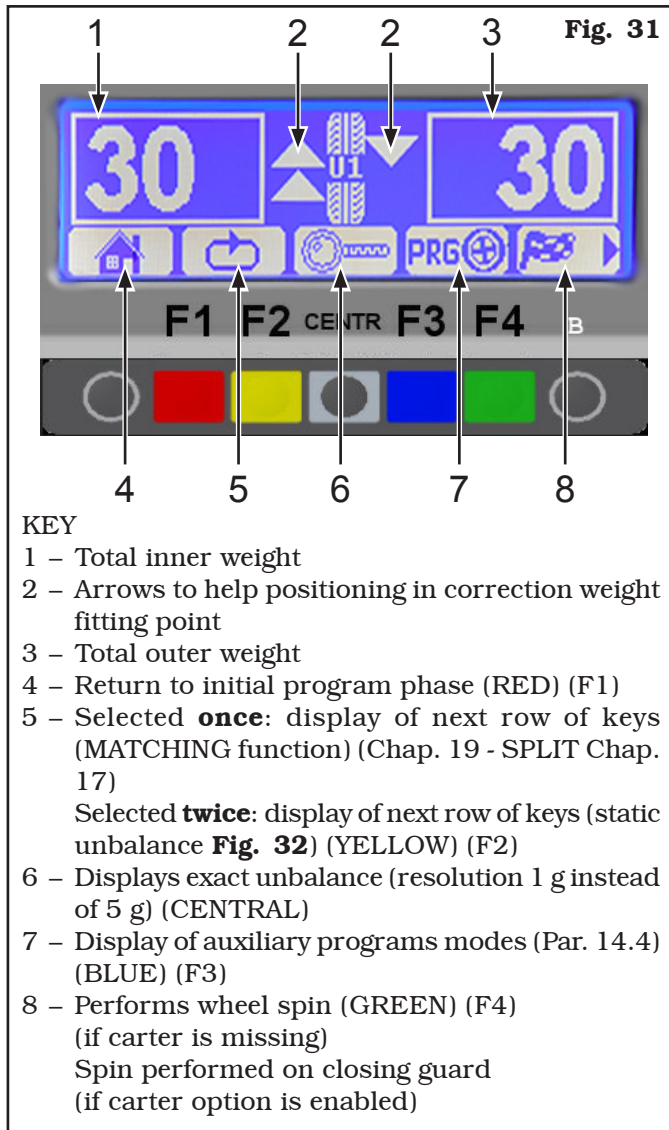
**Fig. 30**

The display unit indicates the direction in which to move the wheel to fit the weights and how much weight is needed to correct the unbalance (**Fig. 31**).

Weight can be determined in "grams" or "ounces"; in this manual examples are shown in grams. To change the unit of measurement from "grams" to "ounces", see Chap. 20.

Once the unbalance of the inside and outside of the wheel is known, it is possible to proceed with positioning for correction of unbalance (Par. 15.3.3).





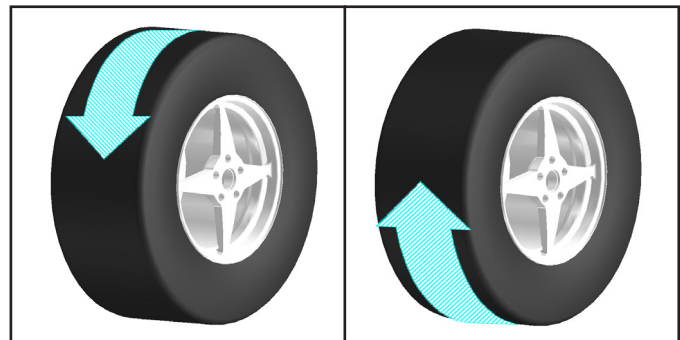
### 15.3.3 Positioning the correction weights on the wheel

The weights must be positioned at the top of the wheel, at “12 o’ clock”, so that the unbalance will be at the bottom and weight fitting point will be at the top.

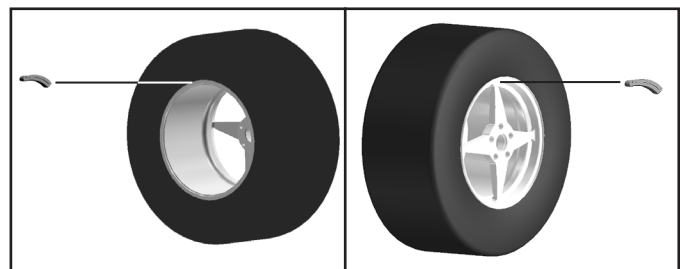
When the wheel balancer display screen shows ▲ or ▲▲ this means you are **very far** from the point where the counterweight is to be positioned.

Wheel position is over 30° from the exact fitting point. When the wheel balancer display screen shows ▲ or ▼ this means you are **not far** from the point where the counterweight is to be positioned.

Wheel position is within 30° from the exact fitting point.



When the wheel balancer display screen shows ➡ (inner side) and ◀ (outer side) the **exact position** has been reached for one side and for the other. The fitting point has been found. Now the unbalance can be corrected by fitting the necessary weight.



Once the wheel has been correctly positioned, fit the weight indicated by the machine on both sides of the wheel. The program automatically indicates the best weights to be fitted and rounds these off according to their position.

Should wheel dynamic unbalance be quite high and the weight to be fitted not available, the SPLIT procedure can be used so as to correct the dynamic unbalance dividing the weight amount into two smaller weights (Chapt. 17).

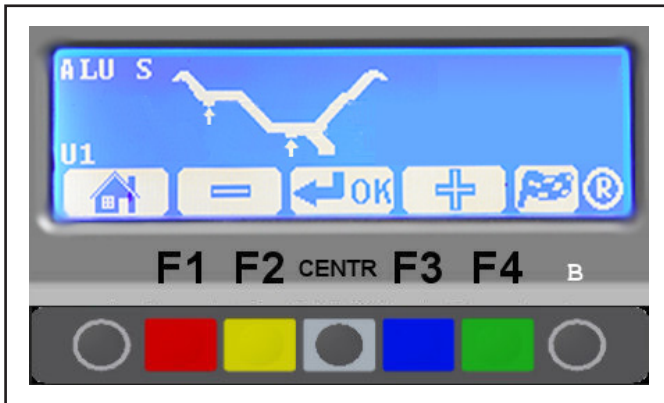
After fitting the weights, check the wheel balancing conditions and make a trial spin.

The STANDARD unbalance calculation procedure is now completed.

### 15.3.4 Wheel balancing with ALU-S program


**Valid for truck/car/motorcycle**



The ALU-S function enables the user to enter 2 different positions for fitting the adhesive weights on the outer and inner side of the rim, so as to select the more suitable position of the weights. The position of the outer weight is not visible but hidden inside. Press the "CENTRE key" to confirm. Enter the measurements (Par. 15.1) and proceed following the instructions below.



Make sure there are no stones and/or mud on the wheel. Remove any counterweights.


Fit the wheel and make sure it is fastened properly.

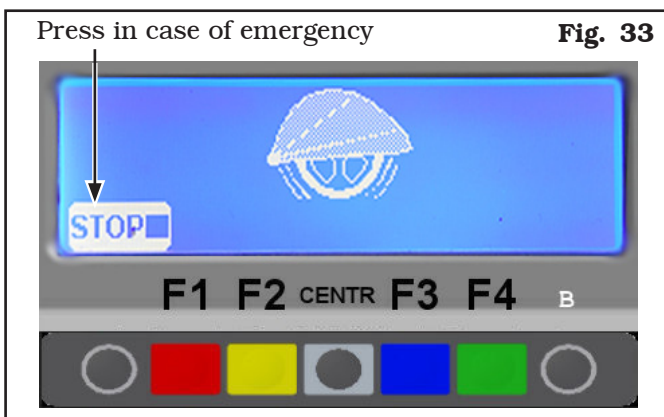
From the initial display page press the "F3 key"  to select the type of desired correction.

Using the  and  key, display the ALU-S function and confirm with the "CENTRE key"



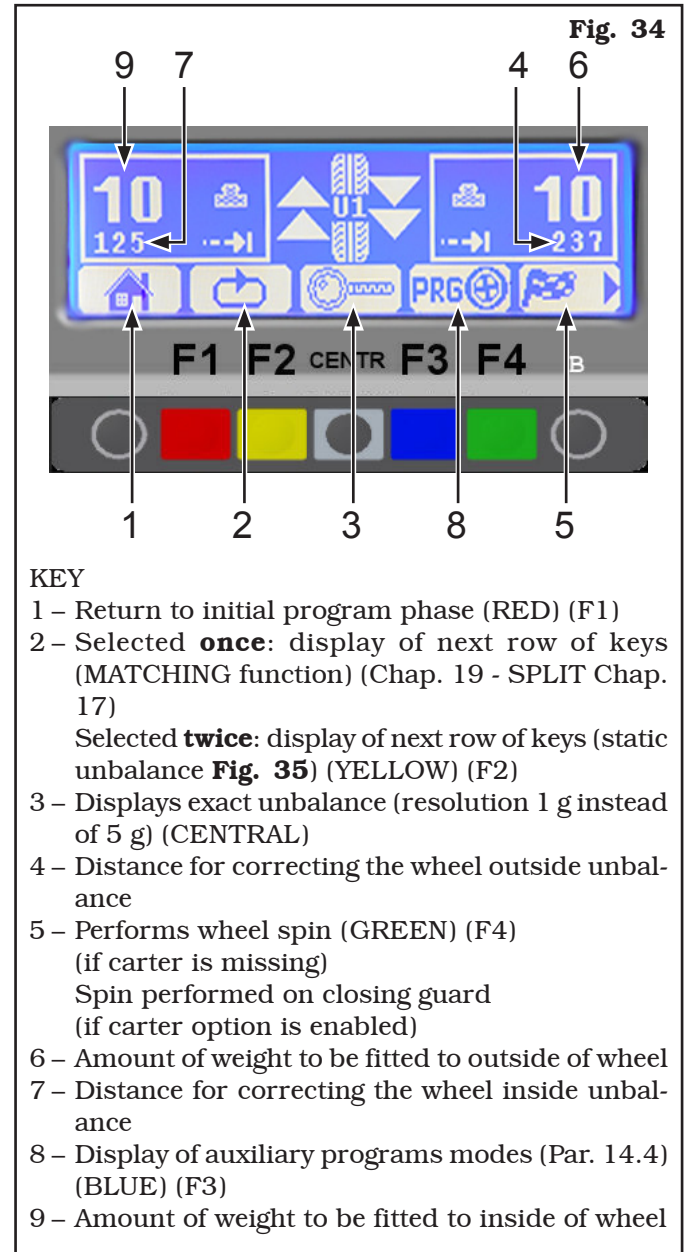
Enter the measurements as indicated in para. 15.1. After entering the measurements, close the guard (if

present) or press "F4 key"  to perform the spin, in just a few seconds, the wheel runs at normal speed and wheel balancer display shows wheel rotation (Fig. 33). Do not touch the wheel while taking measurements. At the end of the spin, the wheel will stop automatically, taking into account the measured unbalance so the outer weight fitting position is at approx. "12 o'clock".



The display unit indicates the direction in which to move the wheel to fit the weights and how much weight and distance are needed to correct the unbalance (Fig. 34).

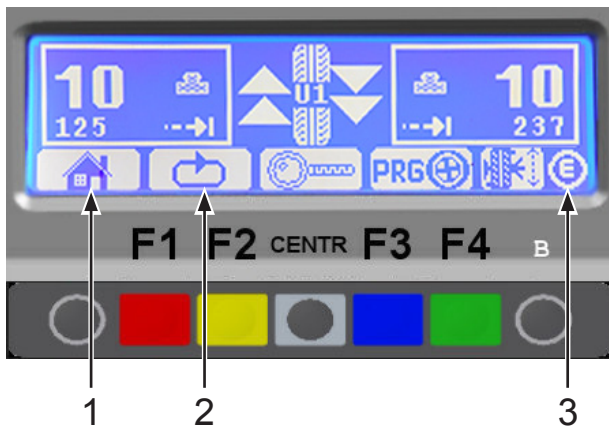
Once the unbalance value of the inner and outer wheel side is known, the wheel can be positioned properly. Turn the wheel in the direction indicated by the arrows (on the outer side, approximately at "12 o'clock") until the correct position is reached (par. 15.3.3).



**KEY**

- 1 – Return to initial program phase (RED) (F1)
- 2 – Selected **once**: display of next row of keys (MATCHING function) (Chap. 19 - SPLIT Chap. 17)
- 3 – Displays exact unbalance (resolution 1 g instead of 5 g) (CENTRAL)
- 4 – Distance for correcting the wheel outside unbalance
- 5 – Performs wheel spin (GREEN) (F4) (if carter is missing)  
Spin performed on closing guard (if carter option is enabled)
- 6 – Amount of weight to be fitted to outside of wheel
- 7 – Distance for correcting the wheel inside unbalance
- 8 – Display of auxiliary programs modes (Par. 14.4) (BLUE) (F3)
- 9 – Amount of weight to be fitted to inside of wheel

Fig. 35



## KEY

- 1 – Return to initial program phase (RED) (F1)
- 2 – Display next row of keys (YELLOW) (F2)
- 3 – ECO-WEIGHT key (B)

Fit the adhesive weight in the measurement gauge as shown in **Fig. 36**.

Fig. 36



Read the outer distance measurement on the distance/diameter caliper. Fit the adhesive weight on the outside of the wheel (**Fig. 37**) at the indicated distance (in the example at 237 mm) using a known weight (the example 10 g). The position of the outer weight is not visible but hidden inside. Turn the wheel until the correct point is reached (par. 15.3.3).



Fig. 37

Read the inner distance measurement on the distance/diameter caliper. Fit the adhesive weight on the inside of the wheel (**Fig. 37**) at the indicated distance (in the example at 125 mm) using a known weight (the example 10 g). Turn the wheel until the correct point is reached (par. 15.3.3). Check wheel balancing conditions by making a trial spin. The display screen will show an unbalance reset.

If the adhesive weight has to be hidden behind spokes, refer to “weights hidden behind spokes mode” in Chapt. 18.


The wheel balancing with ALU-S program is completed.

### 15.4 Measuring the unbalance with auxiliary programs



The available functions allow to select the appropriate weight positions to be placed in different positions compared to the standard ones (DYNAMIC unbalance).

The ALU programs measure rims by means of pre-set data in the wheel balancer.

The measurements entered by the operator will therefore be automatically corrected by the machine according to the selected program.

From the program start page, press "F3 key" .

On the top left of the monitor, the selected mode is displayed. Select the desired mode by means of the

"F3 key"  or "F2"  and enter the measurements required by the selected program.

#### 15.4.1 ALU-S1

**Valid for truck/car**

ALU-S1 function permits balancing wheels with light alloy rims by fitting adhesive weights on the inner side and weight with clip on outer side of wheel.

Enter the measurements (par. 15.1) and proceed as described in par. 15.3.4 (the inner weight is with clip and at 12 o'clock).



#### 15.4.2 ALU-S2

**Valid for truck/car**

ALU-S2 function allows the balancing of wheels with light alloy rims by fitting two adhesive weights on the outer and inner sides of the rim (the outer weight is at "12 o'clock"). Enter the measurements (par. 15.1) and proceed as described in par. 15.3.4 (the inner weight is adhesive and at 12 o'clock).



#### 15.4.3 STATIC 1

**Valid for truck/car/motorcycle**

The STATIC 1 function is a procedure that offsets wheel vibrations using a single weight with clip on a single plane positioned exactly at "12 o'clock".

Enter the measurements (par. 15.1) and proceed as described in par. 15.3.1 (only for wheel inner side).



**15.4.4 STATIC 2****Valid for truck/car**

The STATIC 2 function is a procedure that offsets wheel vibrations using a single adhesive weight on a single plane positioned exactly at 12 o' "clock".

Enter the measurements (par. 15.1) and proceed as described in par. 15.3.1 (only for wheel inner side).

**15.4.5 ALU 1****Valid for car**

ALU 1 function permits balancing wheels with light alloy rims by fitting adhesive weights on the outer sides of the rim at 12 o' clock.

Press the "CENTRE key" to confirm. Enter the measurements (Par. 15.1) and proceed following the instructions below.



Make sure there are no stones and/or mud on the wheel.

Remove any counterweights.

Fit the wheel and make sure it is properly fastened (see Chapt. 12).

From the first display page press the "F3 key" to select the type of desired correction; by means of the

"F3 key" or "F2 key" display the ALU 1 function and determine the dimensions of the wheel using the gauge provided (see Par.15.1).

After data entry, close the protection guard (if any)

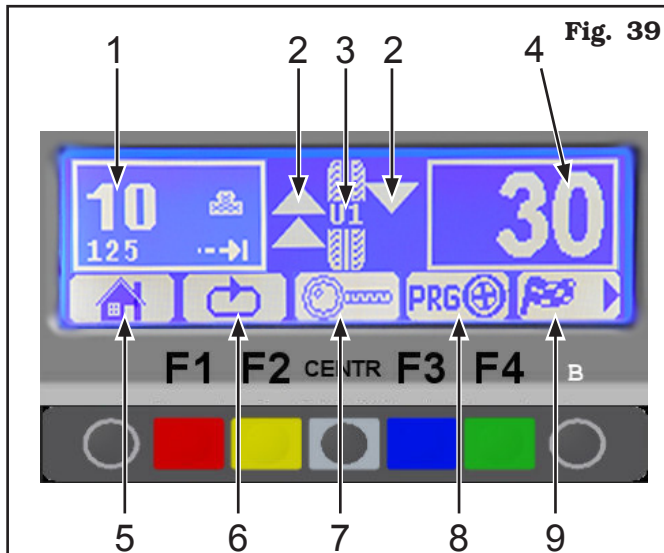
and press "F4 key" to automatically start wheel spin.

In just a few seconds, the wheel runs at normal speed and the wheel balancer display shows wheel rotation (see **Fig. 38**). Do not touch the wheel while taking measurements. At the end of the spin the wheel will stop automatically, also taking into account the measured unbalance so the external weight fitting point is exactly at "12 o' clock". Open the protection guard (if present).

**Fig. 38**

Press in case of emergency

The display unit indicates the direction in which to move the wheel to fit the weight and how much weight is needed to correct the unbalance (see **Fig. 39**). Turn the wheel at the point indicated by the arrows, until the correct position has been reached to correct the unbalance (see Par. 15.3.3).



**KEY**

- 1 – Total inner weight
- 2 – Arrows to help positioning manually the wheel (see Par. 15.3.3) in correction weight fitting point
- 3 – N° of current user
- 4 – Total outer weight
- 5 – Return to initial program phase (RED) (F1)
- 6 – Display next row of keys (MATCHING PROCEDURE and HIDDEN WEIGHTS) (YELLOW) (F2)
- 7 – Displays exact unbalance (resolution 1 g instead of 5 g) (CENTRAL)
- 8 – Display of auxiliary programs modes (see Par. 14.4) (BLUE) (F3)
- 9 – Performs wheel spin (GREEN) (F4) (if carter is missing)  
Performs spin with protection guard closed (if carter option is enabled) (GREEN) (F4)

The adhesive weight on the inner side of the wheel. The inner side weight must be positioned **by hand on the vertical** (**Fig. 40**).



**Fig. 40**

To fit the adhesive weight on the outer part of the wheel, turn the wheel in the direction of the arrows until the correct position is reached (the arrow must be horizontal).

Fit the adhesive weight on wheel outer side. The outer side weight must be positioned **by hand high up on the vertical at "12 o'clock"** (**Fig. 40**), using a weight of pre-determined value (the example in **Fig. 39** shows 32 g).

Check the wheel balancing conditions and make a trial spin.

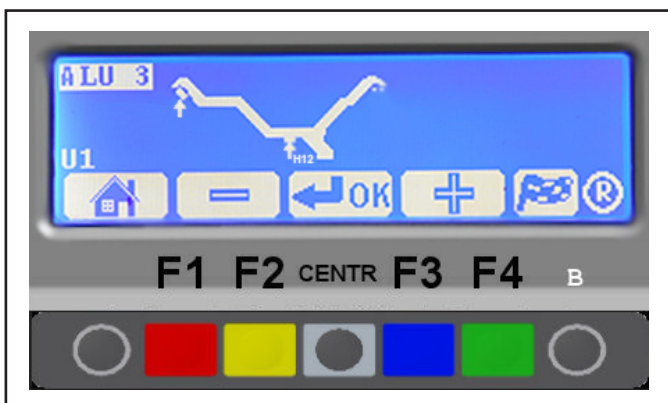
The wheel balancing with ALU 1 program is completed.

**15.4.6 ALU 2****Valid for car**

ALU 2 function balances wheels with light alloy rims by fitting adhesive weights on the outside and inside of the rim at 12 o'clock. The position of the inner weight is not visible but hidden inside. Press the "CENTRE key" to confirm. Enter the measurements (par. 15.1) and execute the spin by pressing "F4" key.

**15.4.7 ALU 3****Valid for car**

The ALU 3 function is a procedure that uses mixed weights to offset wheel unbalance: weight with clip on outer side of wheel, adhesive weight at 12 o'clock on inner side, not visible because inside the rim. Press the "CENTRE key" to confirm. Enter the measurements (par. 15.1) and proceed as for DYNAMIC unbalance.

**15.4.8 ALU 4****Valid for car**

The ALU 4 function is a procedure that uses mixed weights to offset wheel unbalance: weight with clip on outer side of wheel, adhesive weight at 12 o'clock on inner side. Press the "CENTRE key" to confirm. Enter the measurements (par. 15.1) and proceed as for DYNAMIC unbalance.

**15.4.9 PAX****Valid for car**



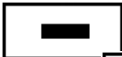
PAX function is a procedure that permits balancing PAX wheels using adhesive weights at pre-set distances to offset wheel unbalance. Press the "CENTRE key" to confirm. Select the wheel type model and proceed following the instructions below.




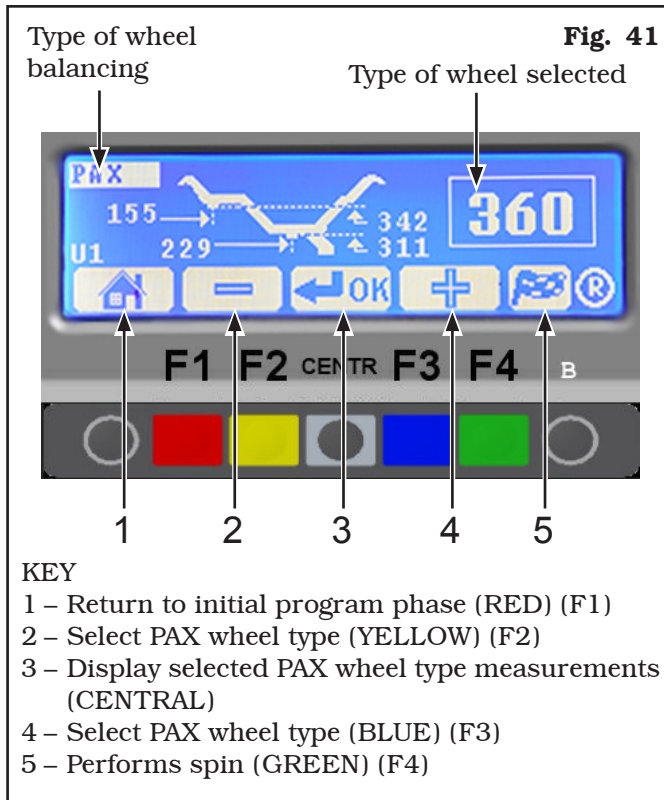
Make sure there are no stones and/or mud on the wheel. Remove any counterweights.


Fit the wheel and make sure it is properly fastened (Chap. 12).

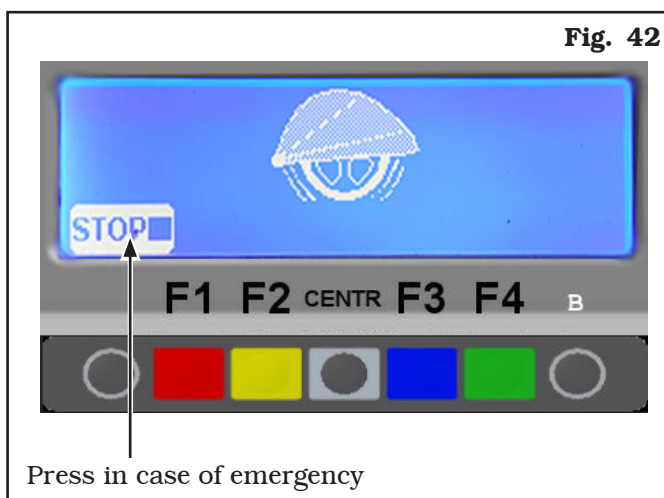
From the initial display page press the "F3 key"

 to select the type of desired correction. Using the "F3 key"  or "F2"  display

PAX function and select the "CENTRE key" 




Select the type of wheel using the “F3 ” or “F2 key” and close the protection guard to start wheel spin. In just a few seconds, the wheel runs at normal speed and the wheel balancer display shows wheel rotation (see **Fig. 42**). Do not touch the wheel while taking measurements. At the end of the spin, the wheel will stop automatically, taking into account the measured unbalance so the outer weight fitting position is at approx. “12 o'clock”. Open the protection guard (if present) or press “F4 key”  and proceed to fit the weight as shown for the ALU-S mode (see Par. 15.3.4).







### **15.5 Recalculation Function**

After making a spin, the wheel automatically stops, and the required weight/s and its/their position is/are always indicated.

If a test is performed in DYNAMIC, ALU-S, or STATIC mode, the data of the other modes can be obtained without making another spin by simply setting other

dimensions and pressing the “Recalculation key  ”

If, for example, from the page where ALU1 results are shown (see **Fig. 39**) key  is pressed, the program displays the list of auxiliary programs (see Par. 15.4).

At this point, select the required program by means of the key  or  , if necessary set the new dimensions and press key R “ ” to obtain the weight and position values in the new mode, taking into account the new dimensions.



### 15.6 ECO-WEIGHT procedure

After making the wheel spin in ALU-S mode, the monitor shows the total of 2 adhesive weights to precisely correct STATIC and DYNAMIC unbalance (see **Fig. 35**). It is possible to fit a single weight at a predetermined distance from the machine, so as to optimize the weight consumption and reduce both the DYNAMIC and any remaining STATIC unbalance as much as possible. Unlike the standard STATIC procedure, the ECO-WEIGHT procedure, though only using one weight, also considerably reduces the DYNAMIC unbalance, because the fitting distance of the weight on the rim is also calculated.

From the ALU-S unbalance results page (see **Fig. 35**),

press the Eco-Weight “**E**” key

The page shown in **Fig. 43** will be displayed.

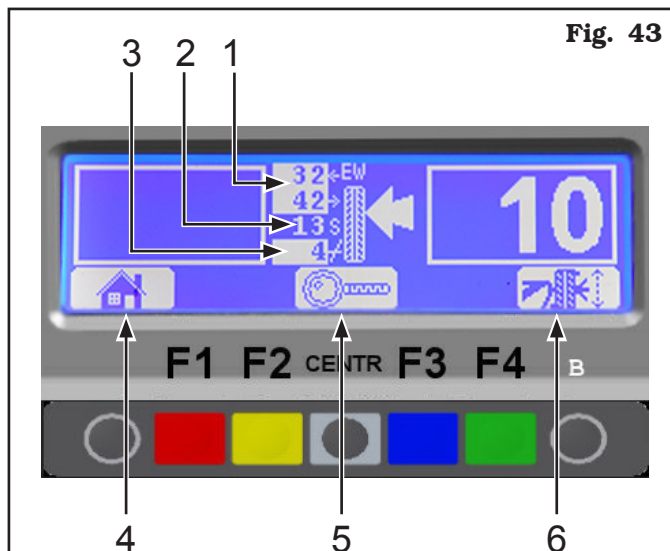


Fig. 43

#### KEY

- 1 – Equivalent dynamic unbalance of the inner and outer side of the wheel
- 2 – Equivalent static unbalance
- 3 – Remaining static weight after performing the ECO-WEIGHT program
- 4 – Return to initial phase (display of ALU-S values) (RED) (F1)
- 5 – Displays the exact unbalance (not approximate at >2 / >5 g) (CENTR)
- 6 – Perform wheel positioning to fit the weight on the other side (GREEN) (F4)

Remove the gauge and fit the adhesive weight in the pliers as shown in **Fig. 44**, using a weight of predetermined value (the example in **Fig. 43** shows 10 g).



Fig. 44

Read the weight fitting distance (see **Fig. 45**) and use the graduated scale, fitted on the distance-diameter caliper, to place the gripper at the correct distance on the outer side of the wheel. Fit the adhesive weight on the outer side of the wheel (see **Fig. 46**) at the distance indicated in **Fig. 45**.

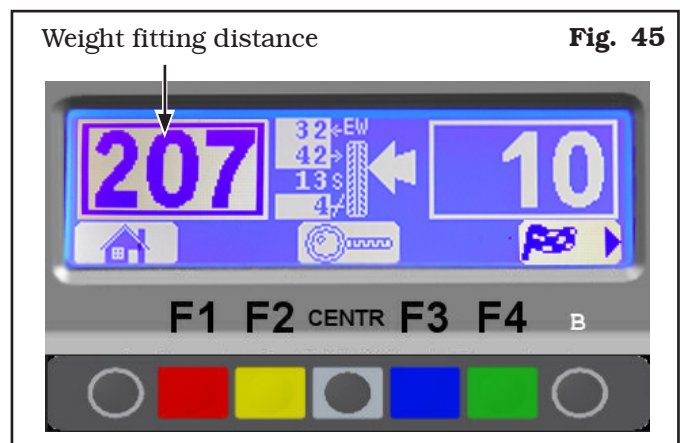


Fig. 45



Fit weight on the position where pliers touches the wheel

Fig. 46

Check the wheel balancing conditions and make a trial spin.

The ECO-WEIGHT procedure is completed.

## 16.0 WHEEL BALANCING IN MOTORCYCLE MODE (WITH DISTANCE CALIPER EXTENSION KIT)

By enabling the "Motorcycle wheel balancing" function (see **Fig. 72**) the wheel balancers can also balance motorcycle wheels.

From the opening page, press the "F2 key" to select car (**Fig. 47**) or motorcycle (**Fig. 48**) balancing mode.



The "motorcycle" mode automatically recalculates the wheel distance measurement, increasing it by the length of the extension supplied with distance caliper extension kit (kit available on demand).



**THE EXTENSION MUST BE FITTED ONLY WHEN BALANCING IS PERFORMED IN "MOTORCYCLE" MODE.**



**TO MOUNT THE EXTENSION AND THE COMPONENTS OF CALIPER EXTENSION KIT, PLEASE REFER TO THE SPECIFIC INSTRUCTIONS INCLUDED IN THE KIT.**

Balancing procedures are identical for both modes (car/motorcycle).

By selecting motorcycle mode, besides dynamic balancing (see Par. 15.3.2) STATIC balancing and/or ALU-S (Par. 15.3.1 and/or 15.3.4) can also be performed.

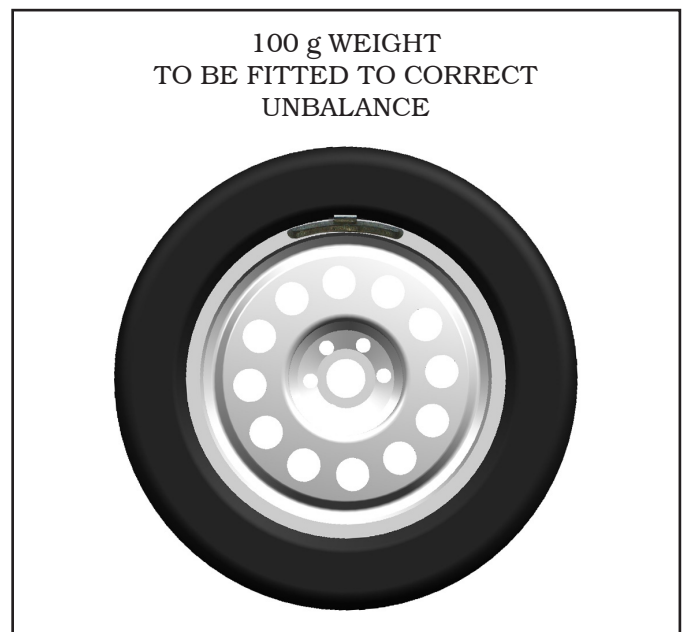
## 17.0 SPLIT PROCEDURE

**Valid for trucks/car/motorcycle**

The SPLIT procedure proves useful when the DYNAMIC unbalance (par. 15.3.2) of a wheel is fairly high and the weight to be fitted is not available, for instance a 100 g weight. It's possible then to correct the unbalance dividing the amount of weight into two weights of smaller size.

The SPLIT procedure eliminates errors caused by manually fitting two 50 g weights close to one another, which could leave considerable outstanding unbalance.

**For example:**



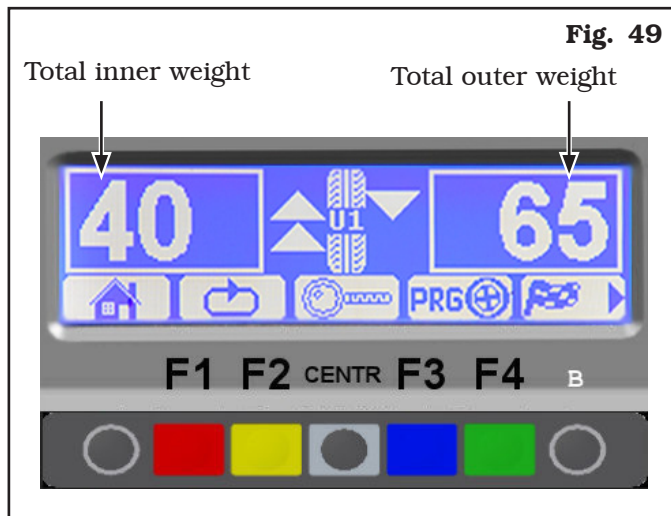



TWO SMALLER WEIGHTS (55g)  
USING SPLIT PROCEDURE

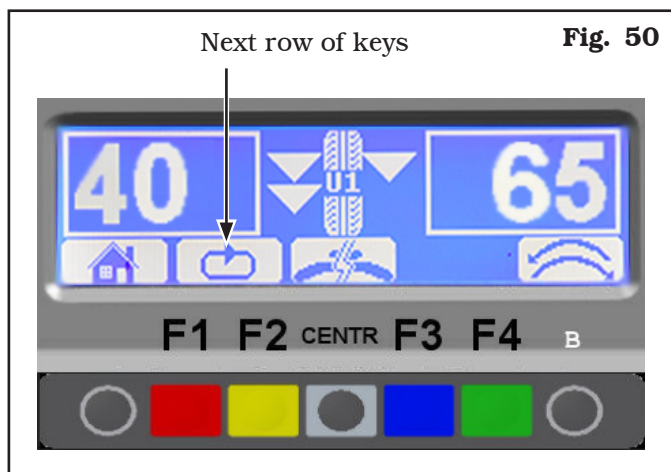


Proceed to dynamic unbalance measurement displaying by performing a standard wheel spin (see Par. 15.3.2).

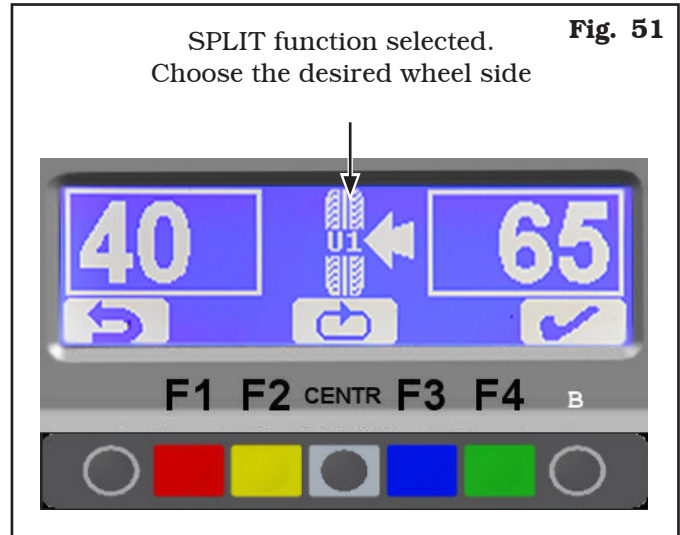
Once the unbalance values have been detected (see Fig. 49):

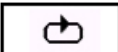


Press "key F2" corresponding to icon . The display screen will show another row of keys (see Fig. 50).

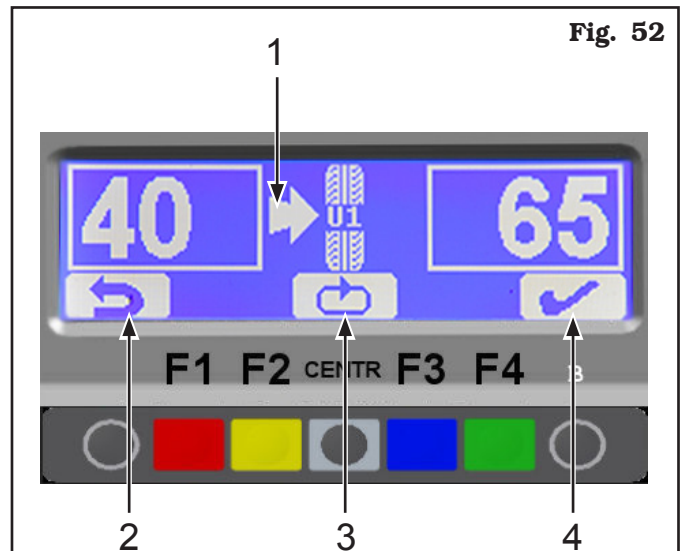


Press the key relating to the SPLIT function , the system will display the page in Fig. 51.



Press "CENTR key" corresponding to icon  to select the desired wheel side (outer or inner). Depending on the selected side, the monitor will show the position of the direction arrows.



Press "key F4"  to confirm.

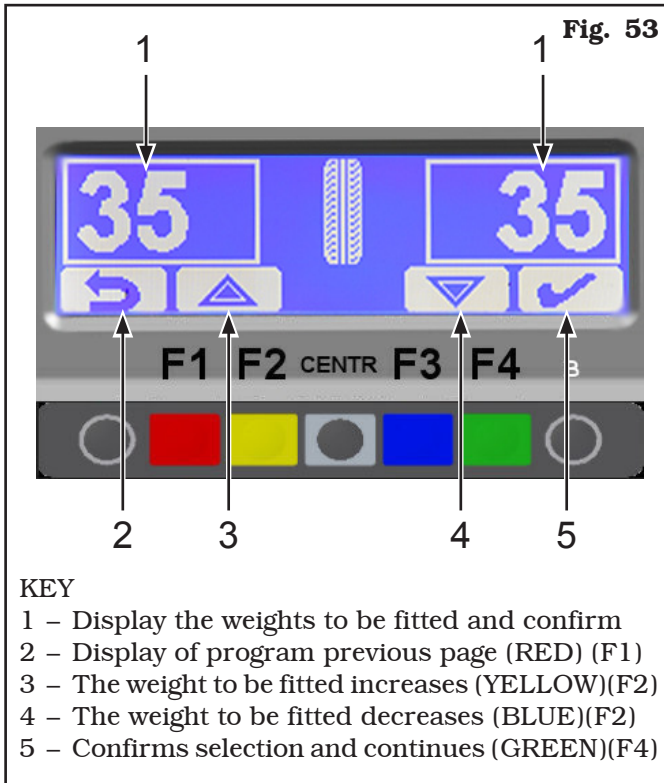


KEY


- 1 - Confirm the wheel side. In the example, the selected side is the inner, where the total weight is lower.
- 2 - Display of program previous page (RED) (F1)
- 3 - Selects wheel side (outer or inner) (CENTR)
- 4 - Confirms selection and continues (GREEN)(F4)

At this point, the system will display the quantity of the two weights to be fitted on the wheel (see **Fig. 53**).

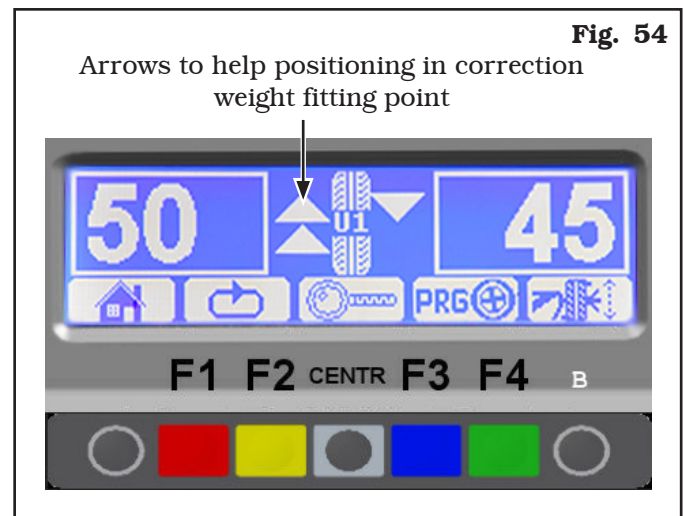
Using the keys corresponding to icons  and , the operator can increase or decrease the quantity of the weights in the awareness that, the bigger the weights, the bigger the distance will automatically be between them.




- KEY**
- 1 - Display the weights to be fitted and confirm
  - 2 - Display of program previous page (RED) (F1)
  - 3 - The weight to be fitted increases (YELLOW)(F2)
  - 4 - The weight to be fitted decreases (BLUE)(F3)
  - 5 - Confirms selection and continues (GREEN)(F4)

Choose the value of the weights to be fitted and press “key F4”  to confirm.

Turn the wheel at the point indicated by the arrows, until the correct position has been reached to correct the unbalance (see Par. 15.3.3).  
When the correct position has been reached, fit the **FIRST** weight.



The monitor again displays **Fig. 54**. Turn wheel at the point indicated by the direction arrows, and fit the **SECOND** weight.  
The inner side operation is complete, press “CENTR” key to quit.

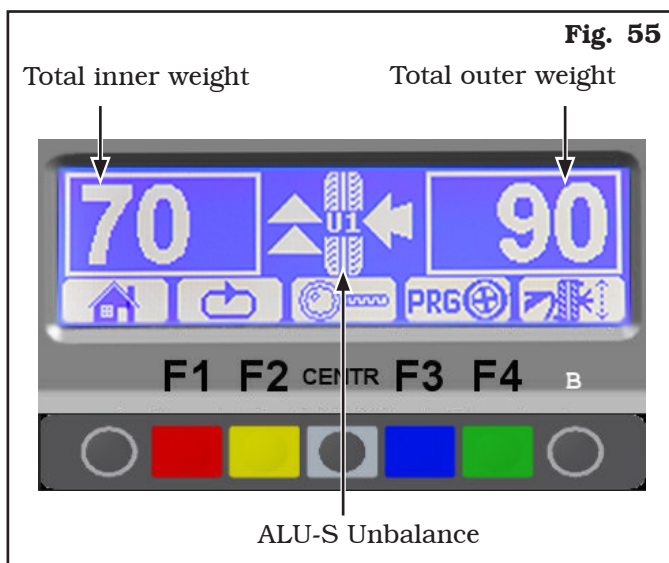
Press the **SPLIT** function key  again (to perform the same operation for the outer side of the wheel) or fit the outer weight on the top part of the wheel, at 12 o'clock.

## 18.0 WEIGHTS HIDDEN BEHIND SPOKES MODE

### Valid for trucks/car/motorcycle

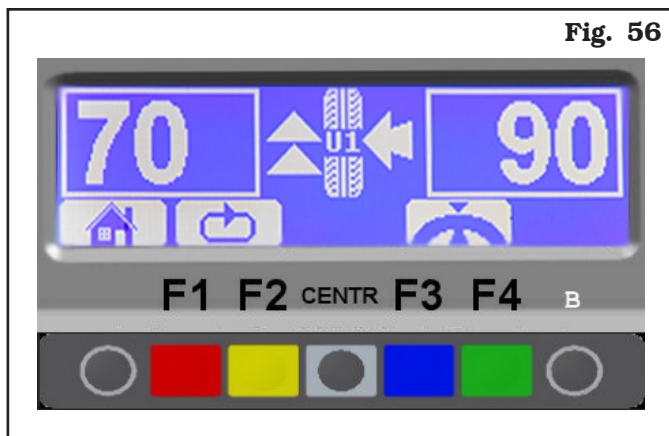
Adhesive correction weight positioning may not look attractive on some types of rims. In this case, "weights hidden behind spokes" mode can be used: it splits any correction weight on the outer side into two parts to be hidden behind rim spokes. It can be used in ALU-S Static mode.

Proceed to display the ALU-S unbalance measurements by performing a spin (see Fig. 55).



Once the unbalance values have been determined,

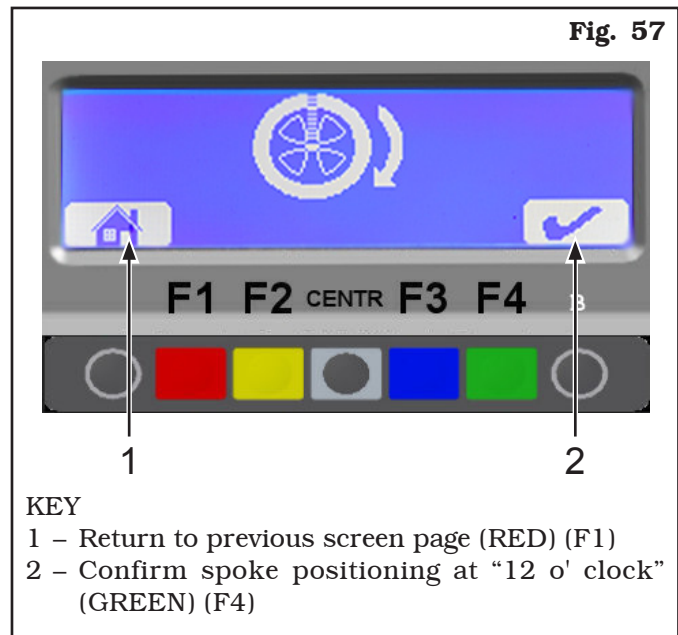
press the "F2 key" corresponding to the icon ; at this point, the next row of keys is displayed on the monitor (see Fig. 56).



Press the "F3 key" relating to the weights hidden behind

spokes mode . The program will display the screen page in Fig. 57.

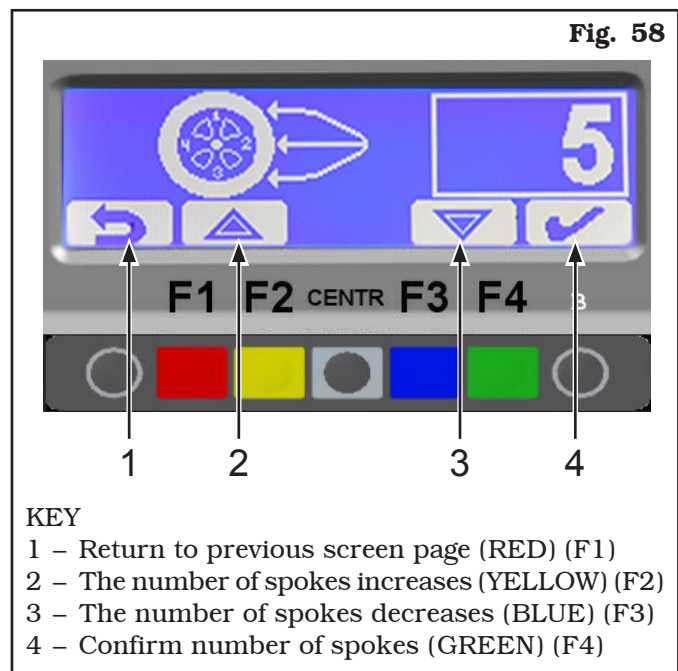
Move any spoke up to "12 o'clock" (in many cases, the position could already be behind or near one of the spokes) and press the "F4 key" to confirm and continue.



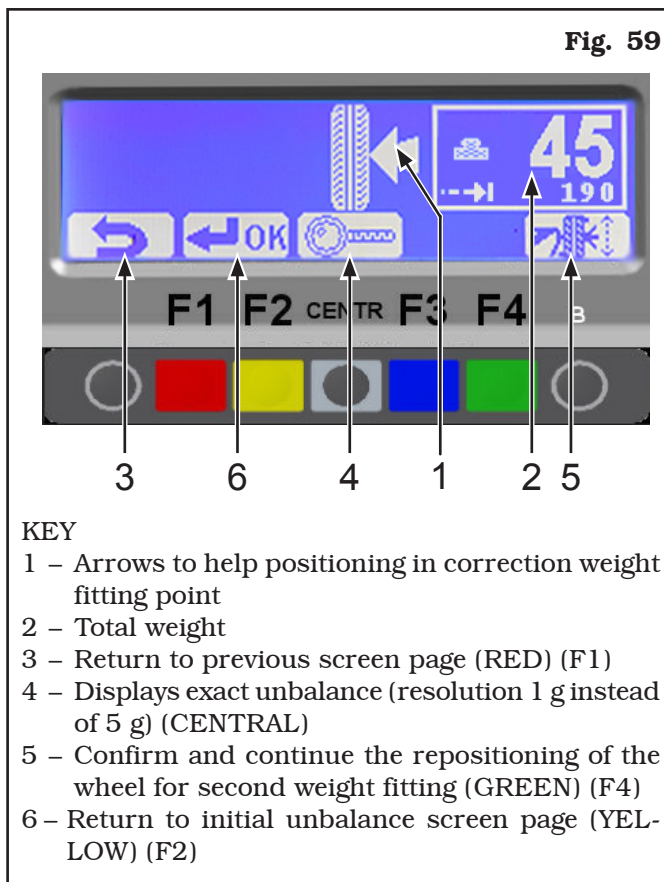
Enter the number of spokes existing on the wheel, using "F2" and "F3 key" (see Fig. 58).

A minimum of 3 spokes and a maximum of 12 can be entered.

Press the "F4 key" to confirm and continue.



The machine automatically calculates weight position in two positions hidden behind the spokes.

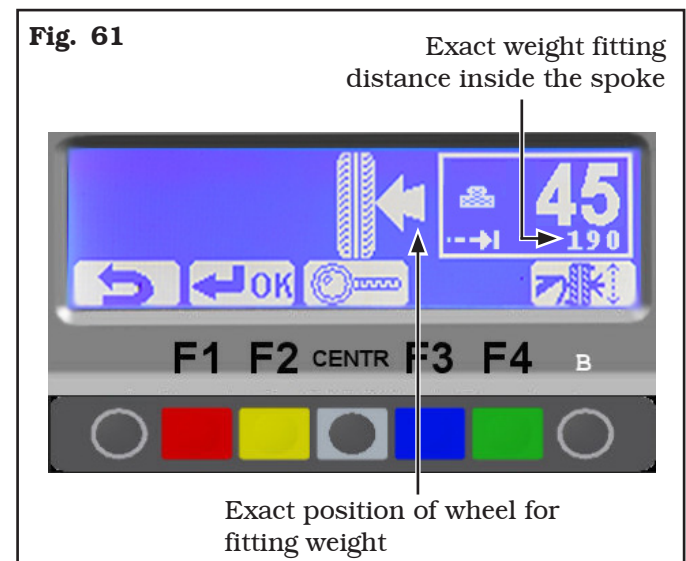


Correctly position the wheel (see Par. 15.3.3) and lock it.

Fit the adhesive weight (in the example this is 45 g) in the gauge as shown in **Fig. 60**.



Fit the adhesive weight inside the spoke at the point indicated on the display screen in **Fig. 61**.



Press the "F4 key" to confirm weight positioning behind the spoke and continue.

The display screen will show the page in **Fig. 59** for fitting the second weight.

Correctly position the wheel (see Par. 15.3.3) and lock it.

Fit the second adhesive weight in the gauge as shown in **Fig. 60**.

Fit the adhesive weight inside the spoke at the point indicated on the display screen in **Fig. 61**.

Press the "F4 key" to confirm positioning of second weight behind the spoke.

The system displays the initial unbalance situation before performing the SPOKES procedure.

Perform another test spin.

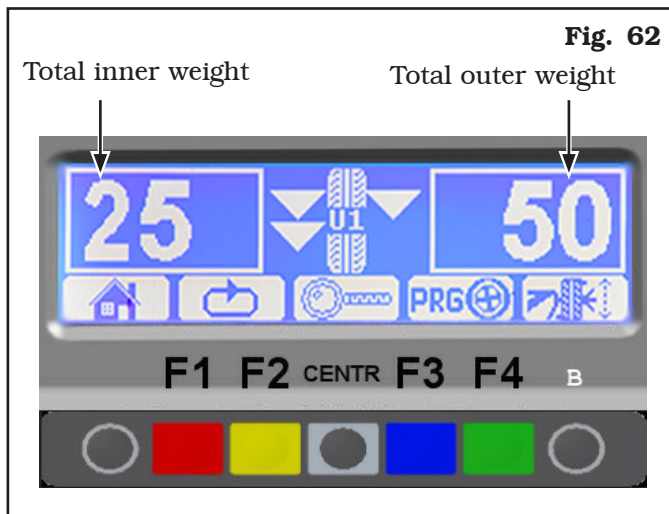
The SPOKES procedure is completed.


## 19.0 MATCHING PROCEDURE (Rim - Tyre Optimization)

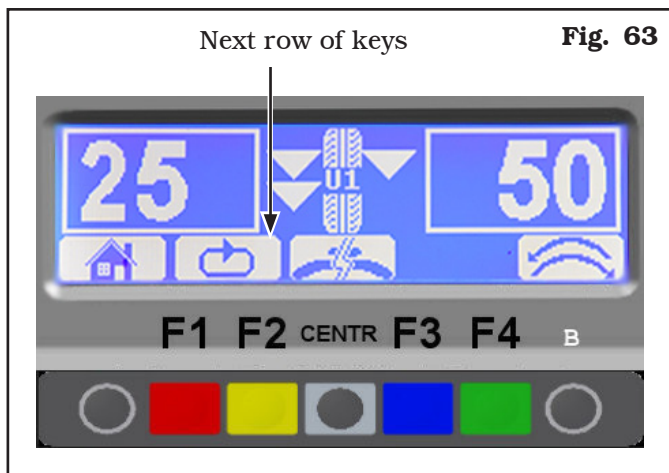
### Valid for car/motorcycle


The Matching procedure offsets strong unbalance, reducing the weight quantity to be fitted on the wheel to achieve balancing. This procedure permits reducing unbalance as much as possible by offsetting the tyre unbalance with that of the rim.

After displaying any unbalance measurement (see example in **Fig. 62**).



Once detected the unbalance measurements, press the F2 key corresponding to the icon . The monitor will show a new key sequence (see **Fig. 63**).

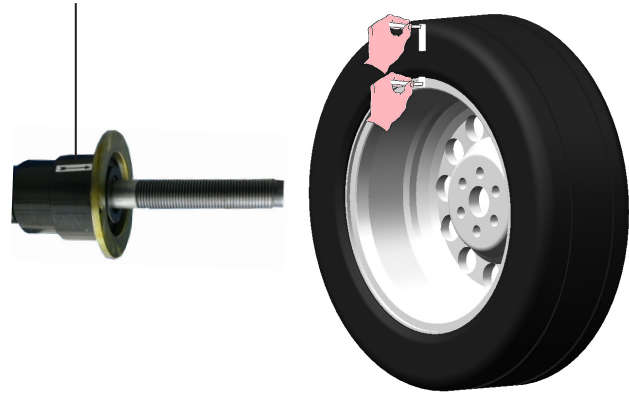


Press the key relating to the MATCHING function  (\*), the system will display the page in **Fig. 64**.

(\*): the MATCHING operation can only be performed if the static unbalance is > of 30 g. If it is less than this, the key relating to this operation is not displayed.

Make a reference mark, using chalk for instance, of the position of the rim and tyre, remaining in line with the arrow on the flange, so as to be able to fit the rim back on in the same position on the machine.

Make a reference mark on the rim and tyre, in line with the arrow on the flange



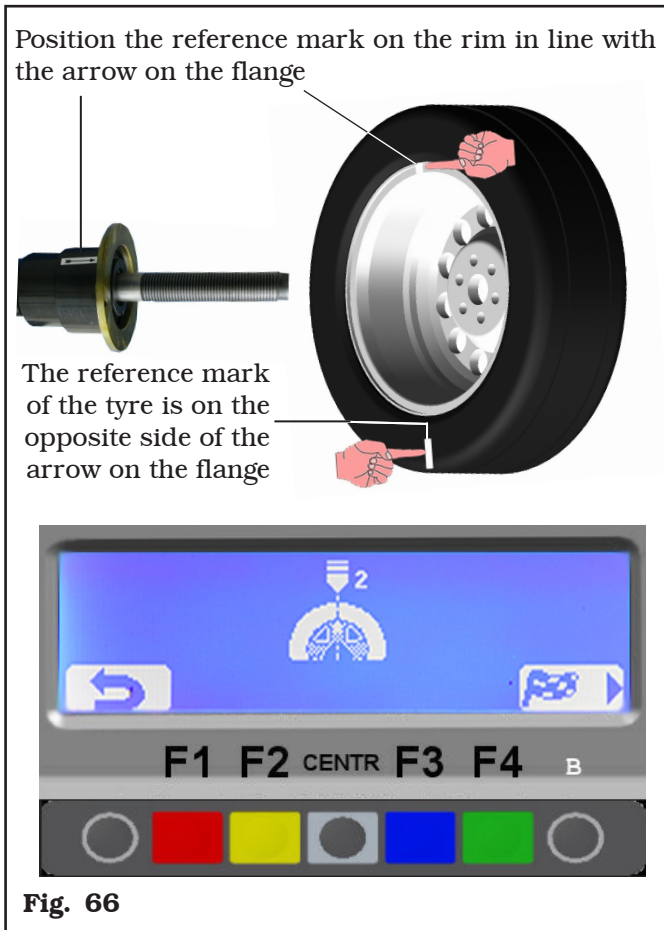
**Fig. 64**

Remove the wheel from the wheel balancer. Remove the tyre and turn it on the rim through 180°.

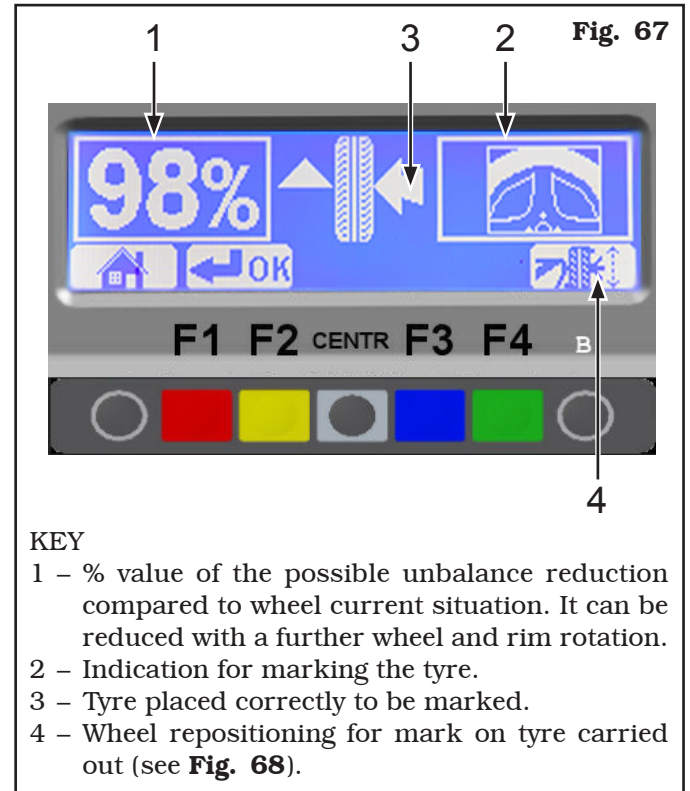


**Fig. 65**

Fit the wheel back on the wheel balancer, positioning the reference mark on the rim in line with the arrow on the flange.



Close the protection guard. Make the second spin by pressing the "F4 key". At the end of the spin the monitor will display the following screen:



You can choose to return back by pressing "F2" key, or continue following further instructions. Cancel the previously made reference marks. Position the wheel following the arrows on the display screen. Look at the arrows on the right. When these are horizontally (see Par. 15.3.3) make the FIRST reference mark on the tyre (see **Fig. 67**).





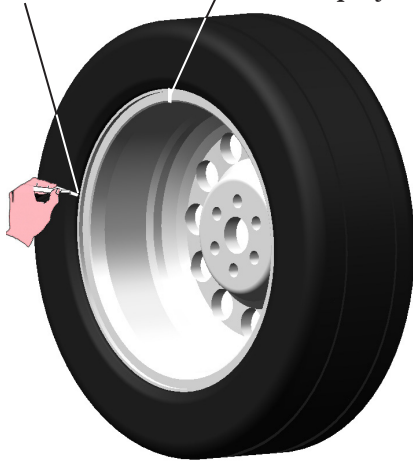
Press the repositioning key "F4" (see **Fig. 67**). Look at the arrows on the left. When these are placed horizontally make the **SECOND** reference mark on the rim.

Fig. 68



FIRST REFERENCE  
MARK ON THE TYRE  
(arrows on the right  
of the display screen)


SECOND REFER-  
ENCE MARK  
ON THE RIM  
(arrows on the left  
of the display screen)



Remove the wheel from the wheel balancer. Remove the wheel and turn the tyre on the rim so that the two points coincide. Fit the wheel on the balancer (see **Fig. 69**) so that the two reference marks next to the arrow on the chuck flange.

Fig. 69



Press the green key corresponding to icon  on the keyboard. The system will again display the page with previous unbalance values.

Perform another spin and correct any residual unbalance using the weights at disposal.

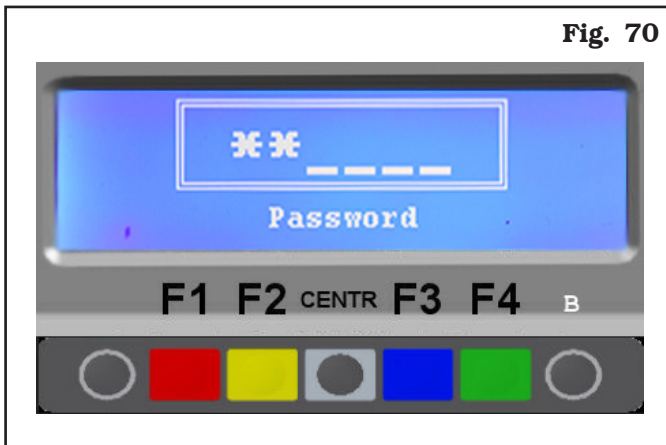
## 20.0 SETUP OF MEASUREMENT, RESOLUTION, WIDTH MEASUREMENT OPTIONS AND SETTING TRUCK/MOTORCYCLE MODE

### 20.1 Unit for measuring the weight and width/diameter of the rim

The weight determining wheel unbalance can be indicated on the display in "gram" or "ounce" measurement unit.

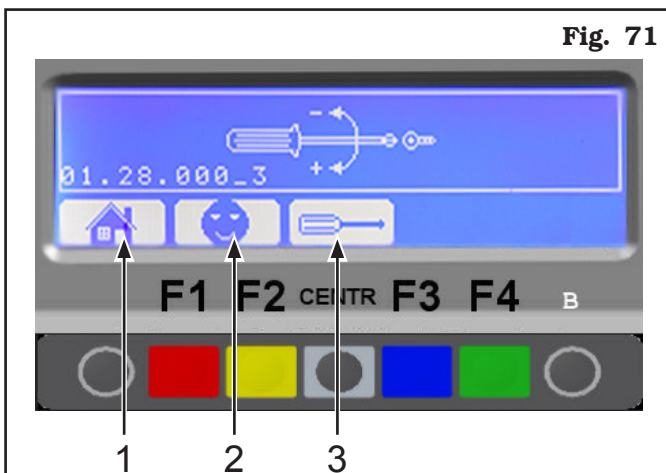
The width and diameter can be indicated in "inches" or "mm"

To change the unit of measurement, press the "F1 key" from the opening presentation page (see **Fig. 18**):



**Fig. 70**


Type in the password **F1-F2-CENTR-F3**, the program will show the screen page in **Fig. 71**:

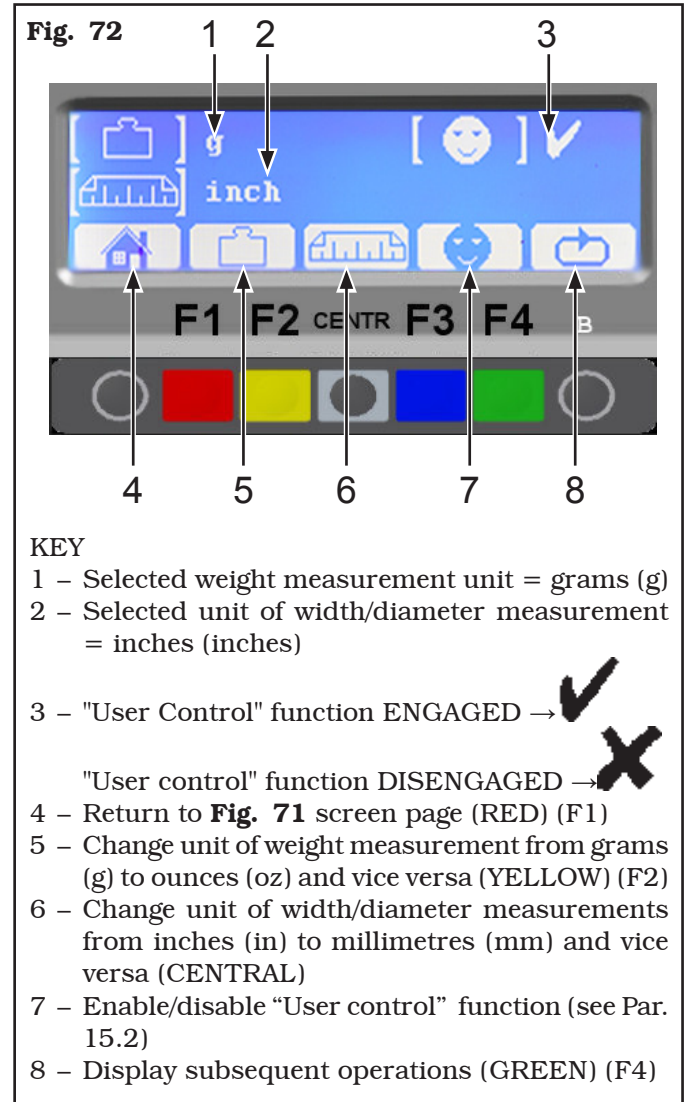


**Fig. 71**

**KEY**



- 1 - Return to initial program page (RED) (F1)
- 2 - Configuration (YELLOW) (F2)
- 3 - Calibrations (CENTRAL)


Press key "F2"  and the program will display the following figure:

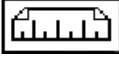


**Fig. 72**


**KEY**

- 1 - Selected weight measurement unit = grams (g)
- 2 - Selected unit of width/diameter measurement = inches (inches)
- 3 - "User Control" function ENGAGED → 
- "User control" function DISENGAGED → 
- 4 - Return to **Fig. 71** screen page (RED) (F1)
- 5 - Change unit of weight measurement from grams (g) to ounces (oz) and vice versa (YELLOW) (F2)
- 6 - Change unit of width/diameter measurements from inches (in) to millimetres (mm) and vice versa (CENTRAL)
- 7 - Enable/disable "User control" function (see Par. 15.2)
- 8 - Display subsequent operations (GREEN) (F4)

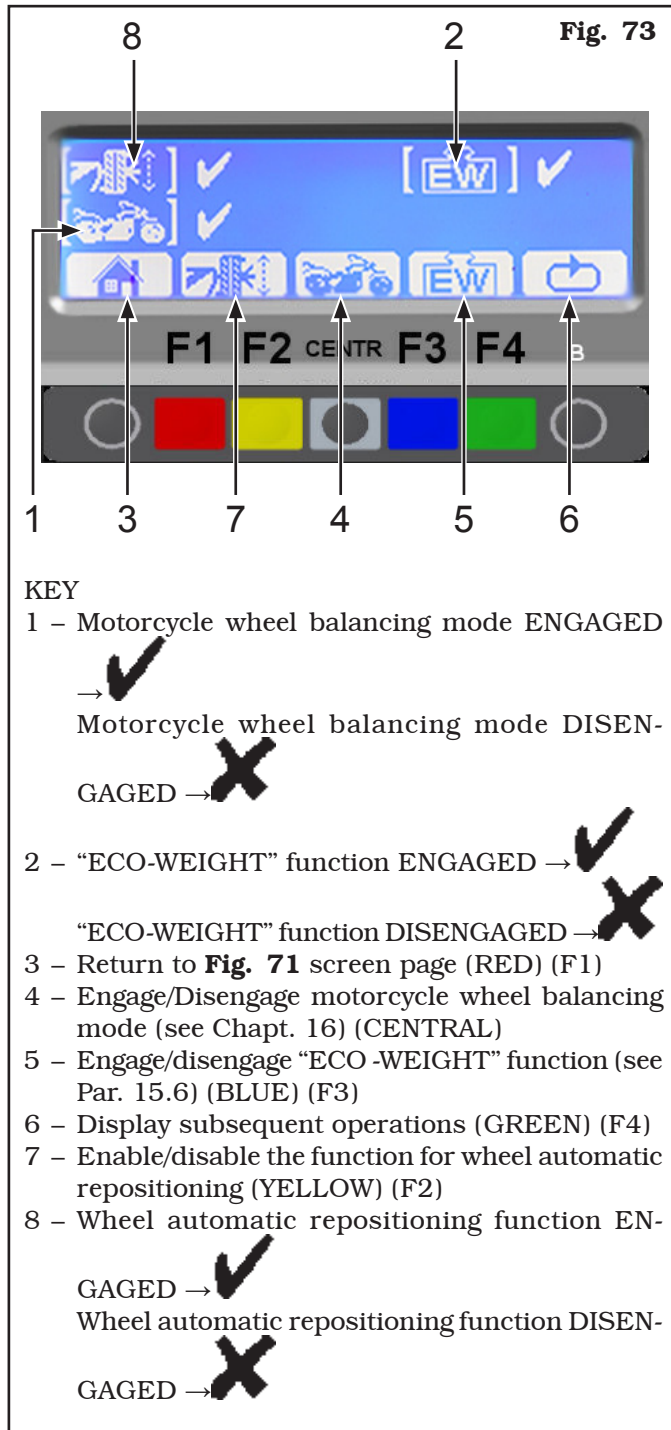
Press the "F2 key"  to change weight unit of measurement from grams to ounces and vice versa. The symbol "g" or "oz" appears on the monitor (see Chap. 22).

Press the "F3 key"  to change the width and diameter unit of measurements from inches to millimetres and vice versa. The symbol "in" or "mm" appears on the monitor.

After setting the required measurement unit, to engage or disengage the motorcycle wheel balancing mode,

press the "F4 key" .

The program will show the following display page:



Press the “CENTR key” to engage or disen-  
gage motorcycle wheel balancing mode (see Chapt. 16).

Press the “F3 key” to engage or disengage  
“ECO -WEIGHT” function (see Par. 15.6).

All the settings of the measurement unit are stored  
even after the machine is switched off.

## 20.2 Setting preview result of static and eco-weight

During the ECO-WEIGHT procedure (see Par. 15.6),  
it is possible to enable or disable the preview of some  
results:

- equivalent static Unbalance of the wheel preview,
- Eco-weight preview.

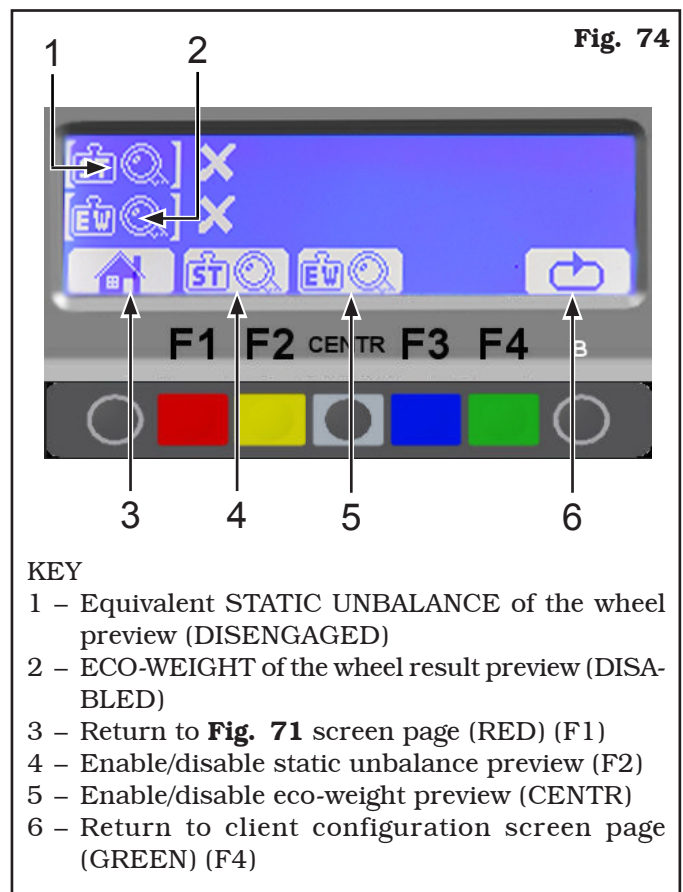
To unable or disable these result previews, press the

“F1” key . The program will show the screen  
page in **Fig. 70**.

Press the “F2 key” . Enter password **F1-F2-  
CENTR-F3** to access the “customer configuration”  
screen page (see **Fig. 72**).

From the “client configuration” page (see **Fig. 71**),

press **3 times in succession** “key F4” . The  
screen page will be displayed as in **Fig. 74**.



To enable/disable required result preview, press the

key or .


When the preview is enabled, this is shown by a mark





At the end press key “F1” to exit.

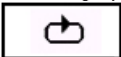
### **20.3 Lower weight limit**


Correction weight below a certain limit is normally shown equal to zero. This limit can be set from 10 g to 1 g.

At the end of the spin however, by pressing the key  (see example **Fig. 31**), the weight can be displayed with max resolution of 1g, not considering the set lower limit.


To change the resolution and lower limit, from the opening presentation page (see **Fig. 18**), press the "F1 key" ; the program will display the page in **Fig. 70**.

Press the "F2 key" . Enter password **F1-F2-CENTR-F3** to access the "customer configuration" screen page (see **Fig. 72**).

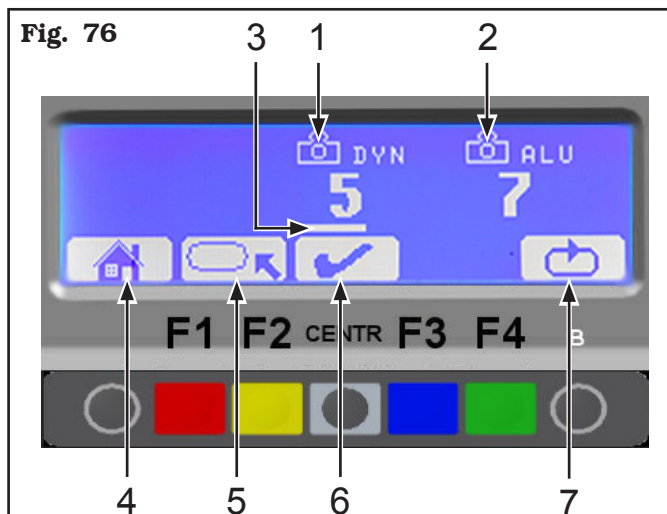
From the "client configuration" page, press **5 successive times** the "F4 key" , the program will show the following screen page:

Move the selection line under the option to be changed by means of the "F2 key" ,

and set the lower limit by means of the "CENTR key" . After terminating the operation, press the "F1 key"  to exit.



**BOTH THE RESOLUTION AND THE LOWER LIMIT FOR DYNAMIC WHEEL BALANCING MODE ARE SET AT 50 G (TRUCK) OR AT 5 G (CAR/MOTORCYCLE). THE LOWER LIMIT FOR ALL THE OTHER MODES IS SET AT 70 G (TRUCK) OR AT 7 G (CAR/MOTORCYCLE).**



- KEY**
- 1 - Lower weight limit setting (5 g) for dynamic wheel balancing mode
  - 2 - Lower weight limit setting (7 g) for ALU (all types) PAX and STATIC modes (all types)
  - 3 - Selection line
  - 4 - Return to **Fig. 71** screen page (RED) (F1)
  - 5 - Move the selection line under the resolution or lower limit value (YELLOW) (F2)
  - 6 - Change the selected values with the selection line (CENTRAL)
  - 7 - Return to client configuration screen page (GREEN) (F4)

## 20.4 Setting adhesive weight dimensions and static threshold percentage

To ensure the balancing machine precisely calculates the dimensions and total adhesive weights, set the thickness and length of the adhesive weights at disposal.

It is also necessary to set the static threshold percentage used in the ECO-WEIGHT procedure

To set the above values, from the opening presentation page (see **Fig. 18**), press the "F1 key" ; the program will display the page in **Fig. 70**.

Press the "F2 key" . Enter password **F1-F2-CENTR-F3** to access the "customer configuration" screen page (see **Fig. 72**).

From the "client configuration" page, press **6 successive times** the "F4 key" ; the program will show the following screen page:

Move the selection line under the option to be changed

using "key F2" . Set the adhesive weight dimensions and the static threshold percentage by means

of the "CENTR key" .

After terminating the operation, press the "F1 key"

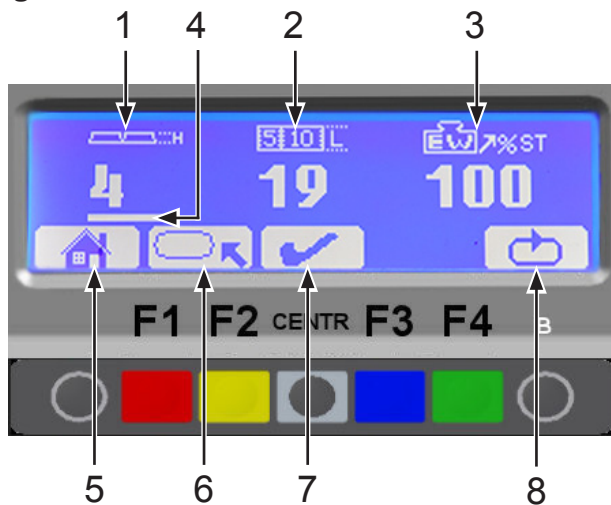


to exit.



**THE SIZE OF THE WEIGHTS STICKERS CAN BE DIFFERENT FOR THE CAR/MOTORCYCLE MODE AND THE TRUCK MODE. ACCORDING TO THE SELECTED MODE (CAR/MOTORCYCLE OR TRUCK) SET THE CORRESPONDING SETTING OF HEIGHT AND WIDTH OF THE WEIGHT TO USE.**

**Fig. 77**





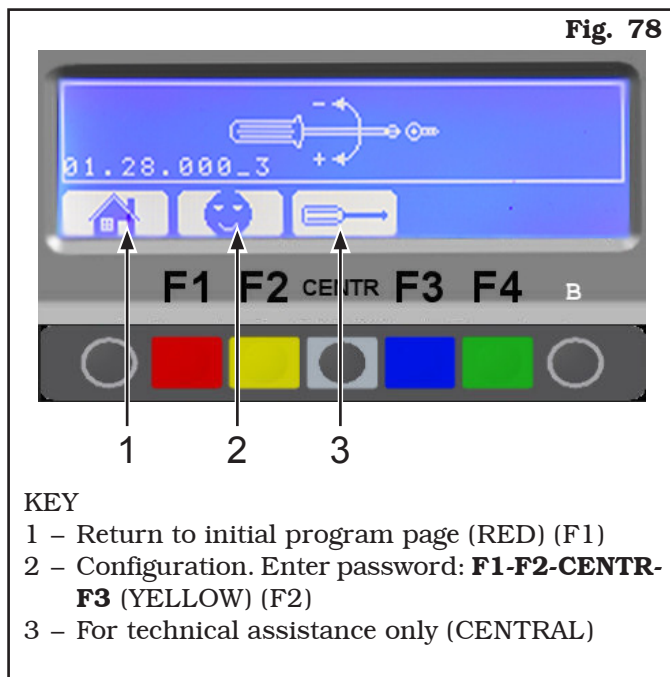
### KEY


- 1 – Setting the adhesive weight thickness (4mm)
- 2 – Setting the adhesive weight length (19 mm)
- 3 – Static threshold percentage used in the ECO-WEIGHT procedure. Can be set between 0 and 200%
- 4 – Selection line
- 5 – Return to **Fig. 71** screen page (RED) (F1)
- 6 – Move the selection line under adhesive weights setting or under the static threshold percentage (YELLOW) (F2)
- 7 – Change the selected values with the selection line (CENTRAL)
- 8 – Return to client configuration screen page (GREEN) (F4)

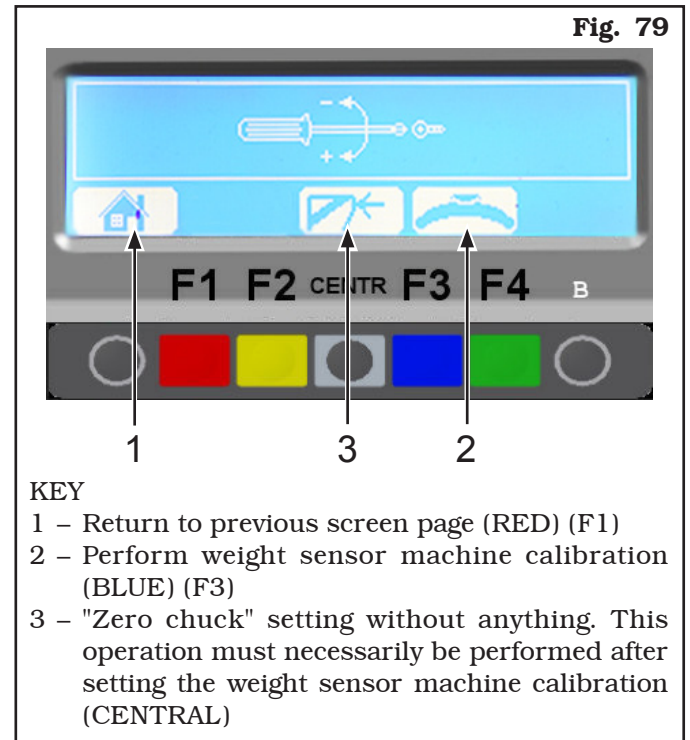
## 21.0 CALIBRATION

### 21.1 Calibration in "CAR" or "MOTORCYCLE" mode

From program presentation screen page, when the machine is set to CAR or MOTORCYCLE mode (the symbol "  " or "  " appears on the screen, see **Fig. 18**) press "F1 key"; the program will display the following screen page:

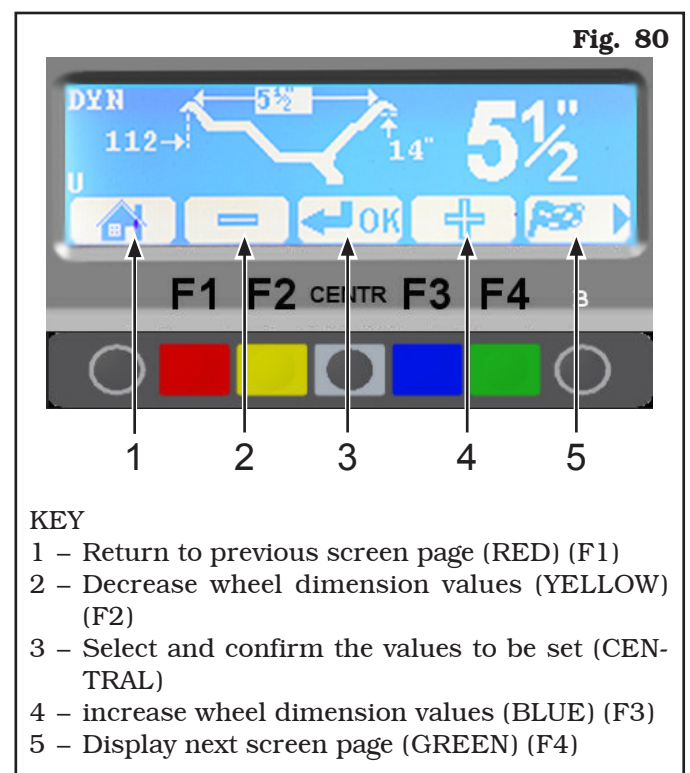




Press the "CENTR key" , enter the password **F1-F2-CENTR-F3**, the program displays the following page:

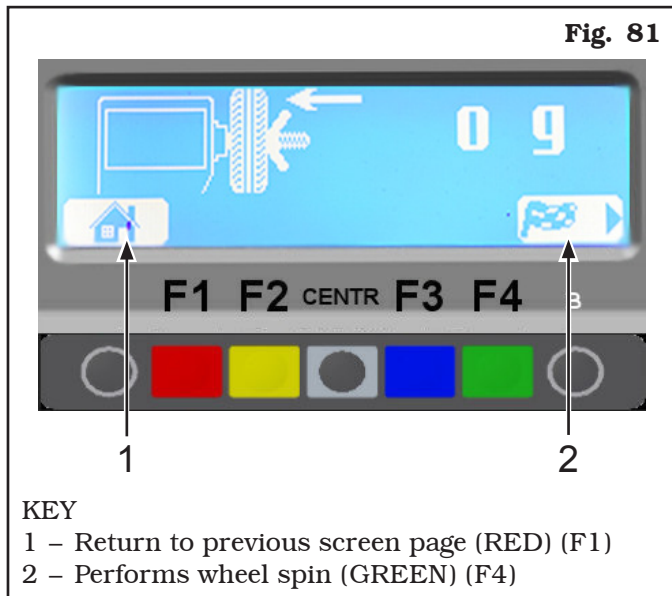


Fit a wheel of medium size, possibly balanced ( $\emptyset = 13 \div 14$ ,  $L = 4 \div 5$ ).

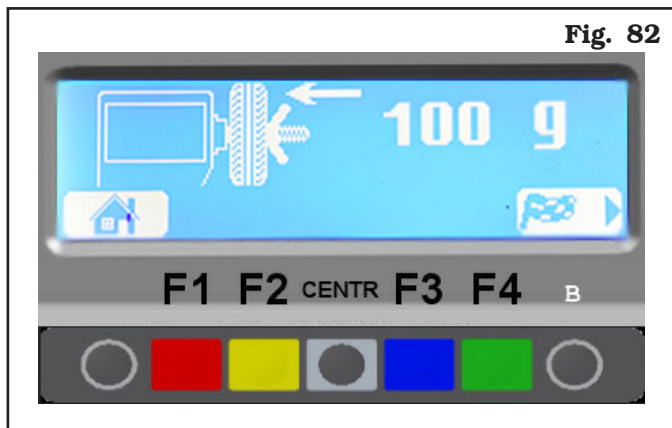
From the calibration page menu (see **Fig. 79**) press the weight sensor calibration "F3 key"; the program will display the following page:



Carefully enter distance, diameter and wheel width measurements, pressing the "CENTRE key" to select each measurement and confirm. Select "  F2" or "  F3" keys to enter the desired values. Press the "F4 key" to continue. The program will show the following display page:



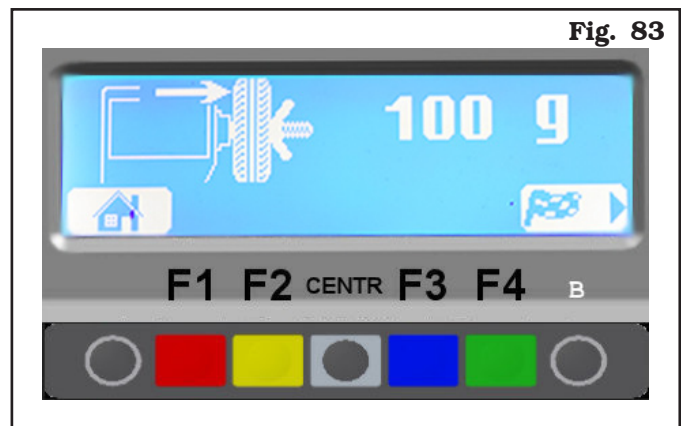
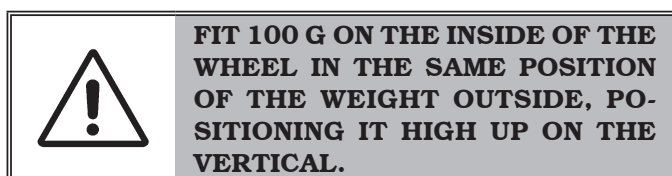
As shown in **Fig. 81**, press the "F4 key" to perform a wheel spin without adding weights. After making the spin, the program will show **Fig. 82**:



Fit 100 g on the outside of the wheel, positioning the weight at "12 o' clock".

Press "F4 key" to perform the spin.

After the spin, remove the 100 g weight from the outside and fit it inside the wheel, as shown in **Fig. 83**.




After the spin, remove the 100 g weight from the inside of the wheel and confirm by means of the "CENTRE key".





The calibration operation is now over. The program will show **Fig. 79**.

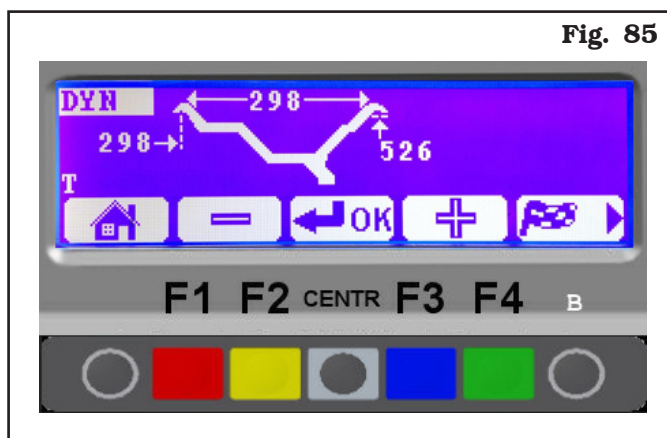
Press the "F1 key" to return to the initial program page.

### 21.2 Calibration in "TRUCK" mode

When the machine is set in truck mode (the symbol  appears on the screen, see chapt. 14) press the "F1 key"; the program shows the page in **Fig. 70**. Enter the password **F1-F2-CENTR-F3** and press "CENTR". The program will show the screen page in **Fig. 79**.

Press "F3"  to continue (or press "F1"  to go back).

The program will display the following image:



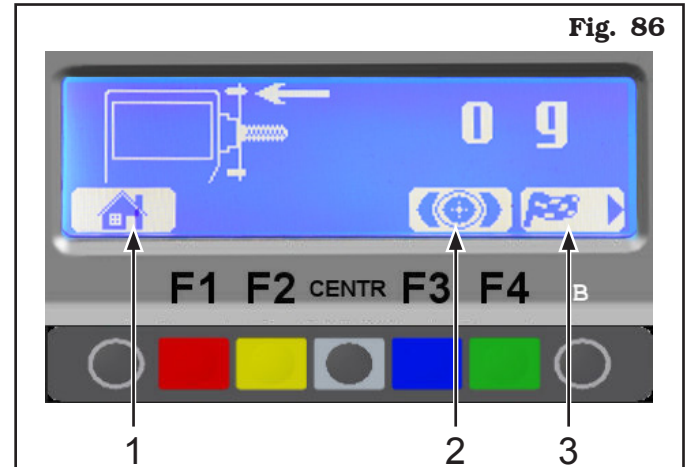
**Fig. 85**

Fit the calibration tool in as indicated in **Fig. 86**, using the two M10 screws provided.



**THE CALIBRATION TOOL MUST  
BE POSITIONED WITH THE LONG-  
ER CYLINDERS IN THE SHAFT  
INNER SIDE.**

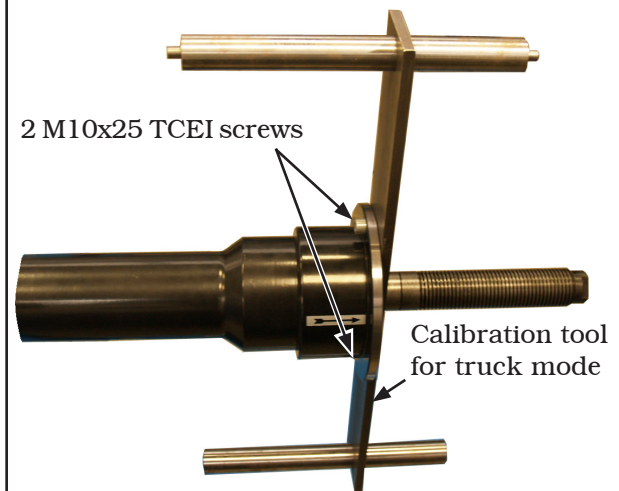
Press "F4"  to confirm the fixed tool measures. The program will display the following image:

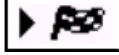


**Fig. 86**

**KEY**

- 1 - Return to previous screen page (RED) (F1)
- 2 - Releases/locks the electropneumatic brake that stops the shaft (BLUE) (F3)
- 3 - Performs wheel spin (GREEN) (F4)

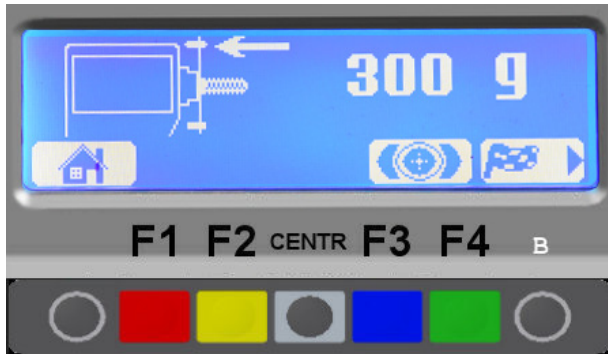


Press the "F4 key"  to perform a spin with the setting tool fitted, but without weights.

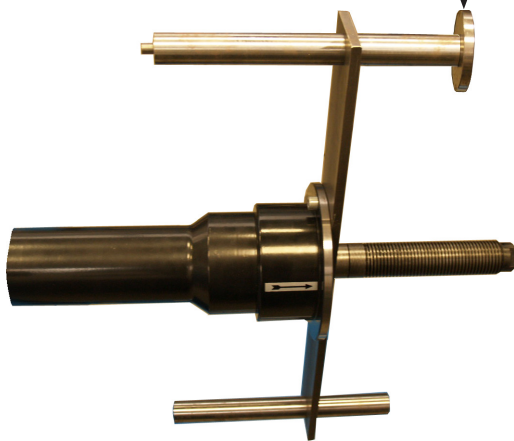


After executing the spin, the program displays the following image:

Fig. 87



300 gr counterweight  
positioned OUTSIDE



**PLACE IT EXACTLY AT "12 O'CLOCK"**

Fit the 300 gr counterweight on the external side and place it exactly at "12 o' clock".

Press "F4 key" to perform the spin.

After the spin, remove the 300 g counterweight from the outside and fit it inside the calibration tool, as shown in **Fig. 88**.

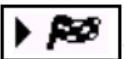
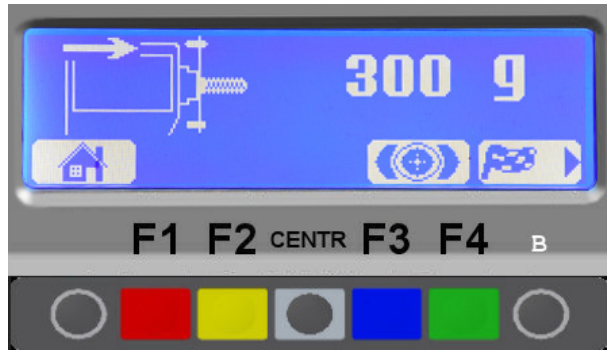
To perform a spin with the counterweight on the internal side, as **Fig. 89**, press the "F4" key .

Fig. 88



300 gr counterweight  
positioned INSIDE

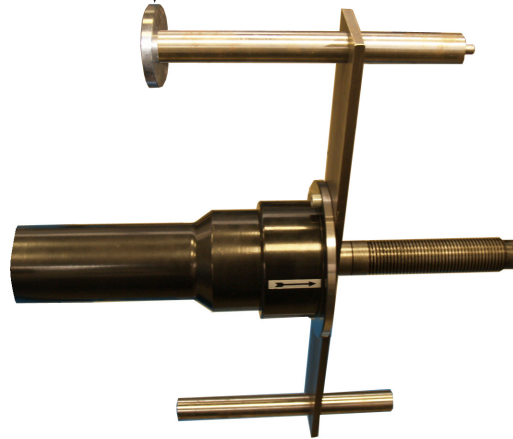



Fig. 89



At the end of the spin remove the calibration tool and

confirm with the "key CENTR" .

The "TRUCK mode" machine calibration operation is terminated.

Press "F1"  to return to the initial program page.

### **21.3 “Zero chuck” setting without anything**

From the setting menu page (see **Fig. 79**) press the "CENTRE" key relating to the "zero chuck" setting. Press key "F4" to perform the chuck reset spin without having fitted anything. Chuck resetting is complete. Press key "F1" to exit.

## **22.0 DISPLAY MODE OF WEIGHTS MEASUREMENT UNIT**

The machine is supplied with "grams" (g) option enabled (see Chap. 20.1), therefore weights will be displayed only in grams.

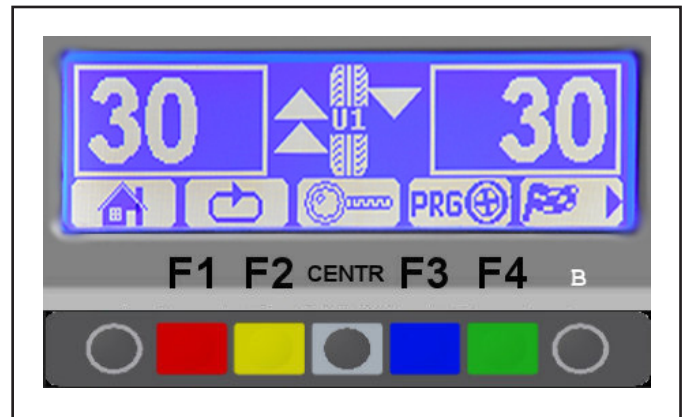
In order to modify the measurement unit carry out the following procedure: if "ounce" option (Oz) is activated from "Configuration" menu (see Par. 20.1), "ounce" weight displaying mode is set.


"Ounces" option enabling allows to switch during the use of the machine from ounce weight display to grams weight display, and vice versa.

### **22.1 Display of the weights in grams**

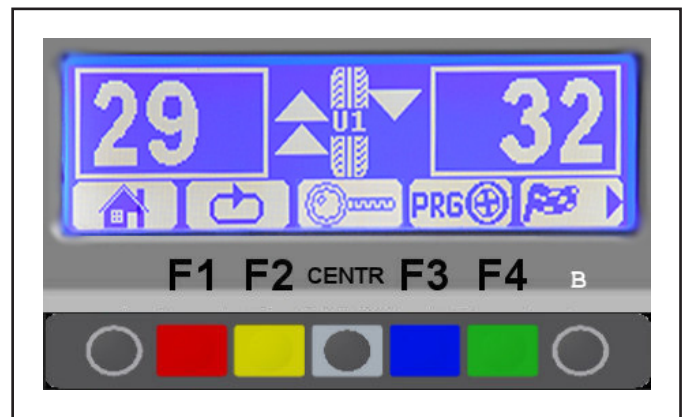
**Select the display of unit of measurement expressed in grams (g) (see Chap. 20.1 - Configuration Menu).**


On the following screen page:

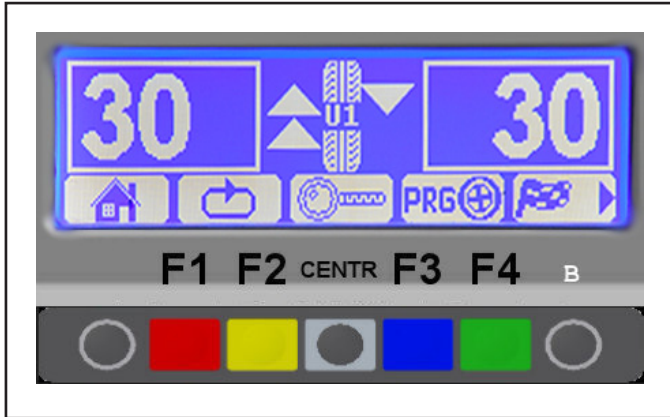


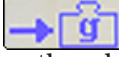
Press the button "CENTR"  to display the weight with maximum resolution (1g) to be fitted on the wheel, expressed in grams.

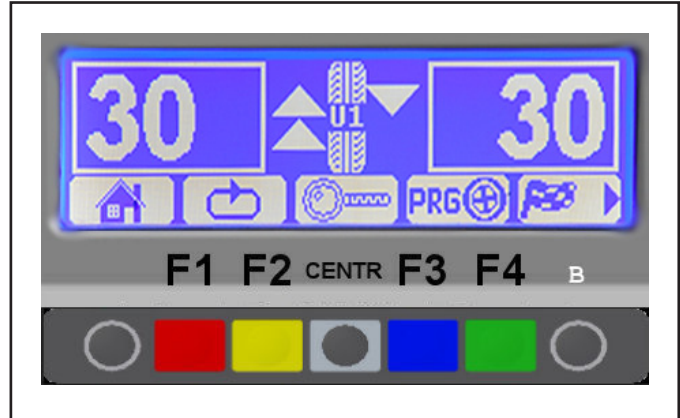
On the monitor the next screen page will be displayed:



Press again the button "CENTR"  to display the approximated weight to be fitted to the wheel, expressed in grams.



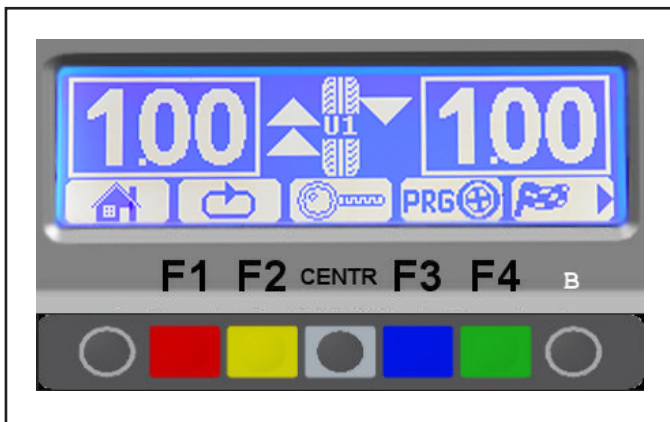
Press the button "CENTR"  to set the display of the weights to be fitted on the wheel in grams. On the monitor the next screen page will be displayed:




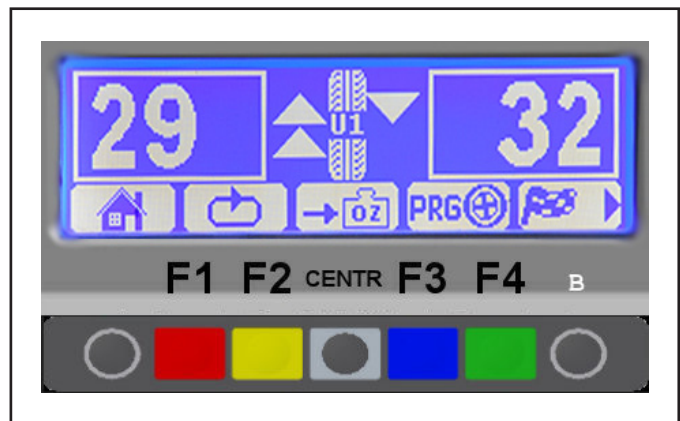
## 22.2 Display of the weights in Ounces / grams


Select the display of unit of measurement expressed in Ounces (oz) (see Chap. 20.1 - Configuration Menu).

On the following screen page:

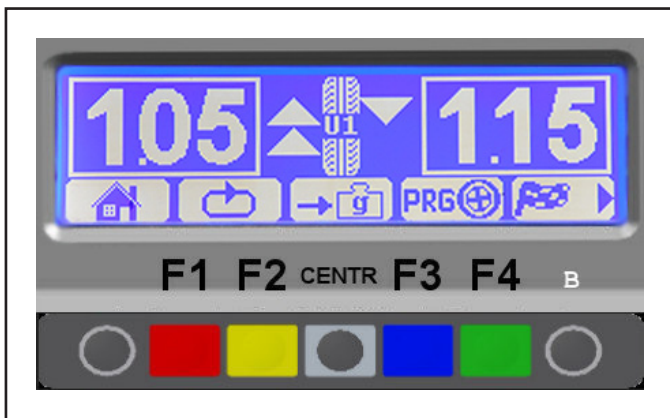



Press the button "CENTR"  to display the weight with maximum resolution (1 g) to be fitted on the wheel, expressed in grams. On the monitor the next screen page will be displayed:

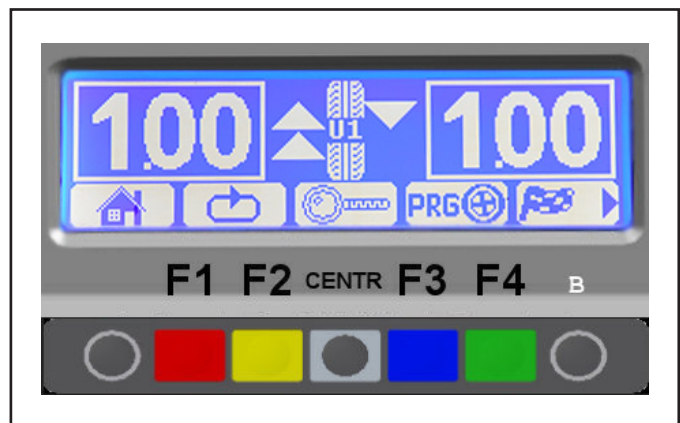


Press the button "CENTR"  to display the weight with maximum resolution (0.05 oz) to be fitted on the wheel, expressed in Ounces.


On the monitor the next screen page will be displayed:



Press the button "CENTR"  to set the display of the weights to be fitted on the wheel in Ounces. On the monitor the next screen page will be displayed:



### 23.0 ERROR SIGNALS

During wheel balancer operation, if wrong commands are given by the operator or device faults occur, an error code or symbol may appear on the display screen. Press key F1  to return to the previous program phase after remedying the fault. Below is a troubleshooting chart.

<b>Error code</b>	<b>Error description</b>	<b>Cause</b>
2	No rotation signal	<ul style="list-style-type: none"> <li>- Faulty position transducer or transducer not fitted correctly.</li> <li>- The motor is faulty or has not started because something is preventing its rotation.</li> </ul>
3	Excessive weight value in wheel balancer calibration	During the calibration procedure, the machine detects excessive weight. <ul style="list-style-type: none"> <li>- The weight may not have been fitted properly.</li> <li>- The data acquisition or measurement sensor may be faulty.</li> </ul>
8	Insufficient weight value in wheel balancer calibration	During the calibration procedure, the machine detects insufficient weight. <ul style="list-style-type: none"> <li>- The weight may not have been fitted properly.</li> <li>- The data acquisition or measurement sensor may be faulty.</li> </ul>
9	Calibration spin not completed	During the calibration procedure, the spin is not completed because the key has been pressed (STOP).



## 24.0 ROUTINE MAINTENANCE



**BEFORE CARRYING OUT ANY ROUTINE MAINTENANCE OR ADJUSTMENT PROCEDURE, POSITION THE MAIN SWITCH "0", DISCONNECT THE MACHINE FROM THE ELECTRICITY SUPPLY USING THE SOCKET/PLUG COMBINATION AND CHECK THAT ALL MOBILE PARTS ARE AT A STANDSTILL.**



**BEFORE EXECUTING ANY MAINTENANCE OPERATION, MAKE SURE THERE ARE NO WHEELS LOCKED ONTO THE CHUCK.**

To guarantee the efficiency and correct functioning of the machine, it is essential to carry out daily or weekly cleaning and weekly routine maintenance, as described below.

Cleaning and routine maintenance must be conducted by authorized personnel and according to the instructions given below.

- Remove deposits of tyre powder and other waste materials with a vacuum cleaner.

**DO NOT BLOW IT WITH COMPRESSED AIR.**

- Do not use solvents to clean the pressure regulator.



**ANY DAMAGE TO THE MACHINE DEVICES RESULTING FROM THE USE OF LUBRICANTS OTHER THAN THOSE RECOMMENDED IN THIS MANUAL WILL RELEASE THE MANUFACTURER FROM ANY LIABILITY!!**

**25.0 TECHNICAL DATA****25.1 Technical electrical data**

Max. absorbed voltage (W)		250
Power supply	Voltage (V)	230
	Phases	1
	Frequency (Hz)	50/60
Rotation speed (rev/min)		100 (car) - 80 (truck)

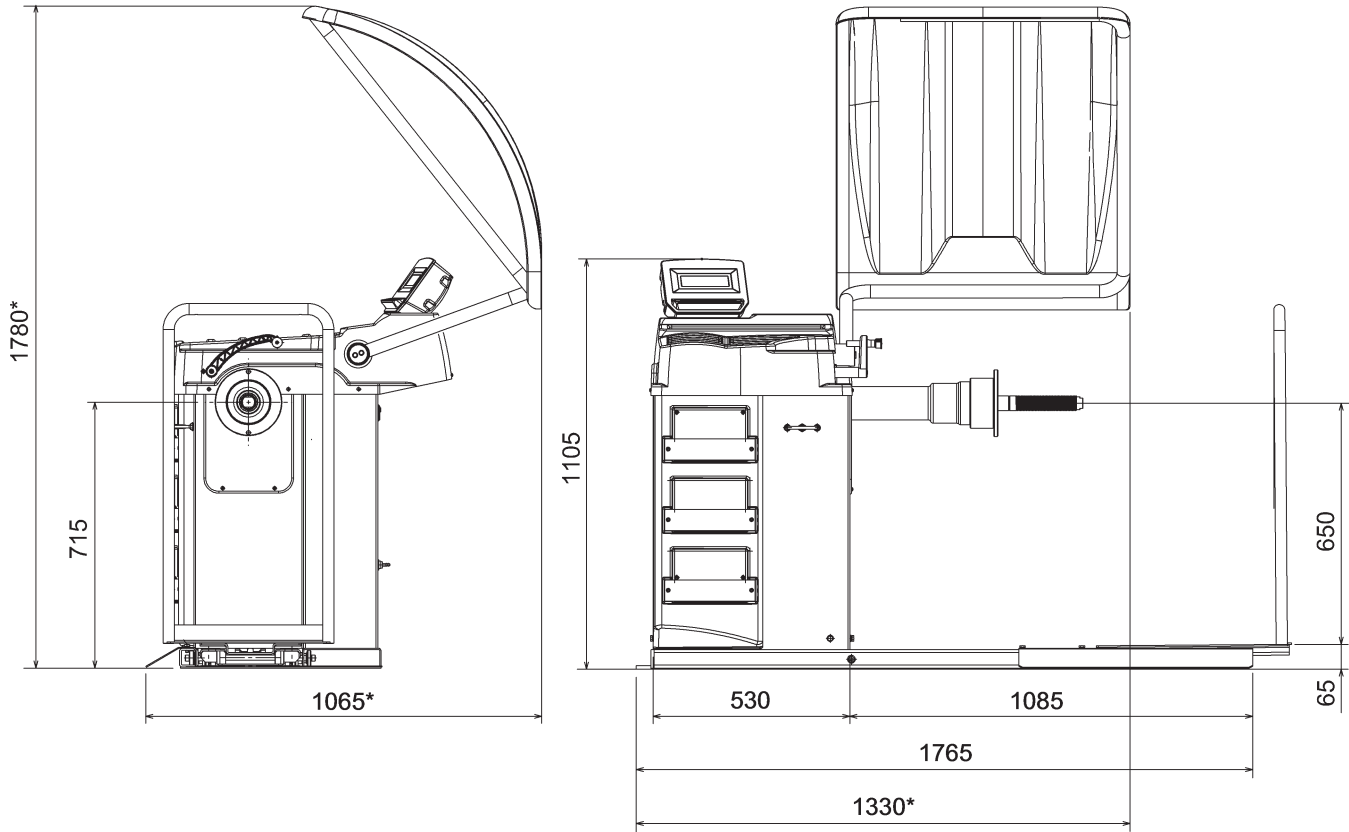
**25.2 Technical mechanical data**

Balancing precision (g)	$\pm 1$ (car) - $\pm 10$ (truck)
Rim width (inches)	1.5 ÷ 22
Rim diameter (inches)	10 ÷ 26 (manually up to 30)
Max wheel diameter inside protection (mm)	1300
Max wheel width inside protection (mm)	700
Cycle time (sec)	6
Sound emission level (dBA)	< 70
Air supply (Pneumatic lifting) (bar)	4 ÷ 10
Max. wheel weight (kg)	200

Weight (Kg)	175
-------------	-----

### 25.3 Dimensions

Fig. 90



\* Optional

## 26.0 STORING

If storing for long periods disconnect the main power supply and take measures to protect the machine from dust build-up. Lubricate parts that could be damaged from drying out.

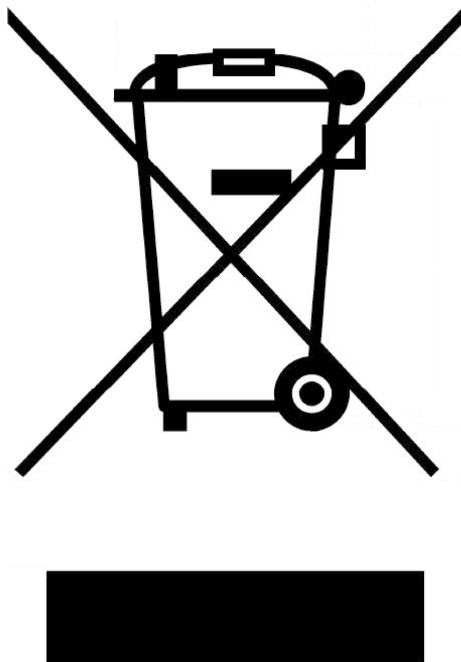
## 27.0 SCRAPPING

When the decision is taken not to make further use of the machine, it is advisable to make it inoperative by removing the connection pressure hoses. The machine is to be considered as special waste and should be dismantled into homogeneous parts. Dispose of it in accordance with current legislation.

**Instructions for the correct management of waste from electric and electronic equipment (WEEE) according to the Italian legislative decree 49/14 and subsequent amendments.**

In order to inform the users on the correct way to dispose the product (as required by the article 26, paragraph 1 of the Italian legislative decree 49/14 and subsequent amendments), we communicate what follows: the meaning of the crossed dustbin symbol reported on the equipment indicates that the product must not be thrown among the undifferentiated rubbish (that is to say together with the "mixed urban waste"), but it has to be managed separately, to let the WEEE go through special operations for their reuse or treatment, in order to remove and dispose safely the waste that could be dangerous for the environment and to extract and recycle the raw materials to be reused.

**Fig. 91**



## 28.0 REGISTRATION PLATE DATA



**The validity of the Conformity Declaration enclosed to this manual is also extended to products and/or devices the machine model object of the Conformity Declaration can be equipped with.**



**ATTENTION: TAMPERING WITH, CARVING, CHANGING ANYHOW OR EVEN REMOVING MACHINE IDENTIFICATION PLATE IS ABSOLUTELY FORBIDDEN; DO NOT COVER IT WITH TEMPORARY PANELS, ETC., SINCE IT MUST ALWAYS BE VISIBLE.**

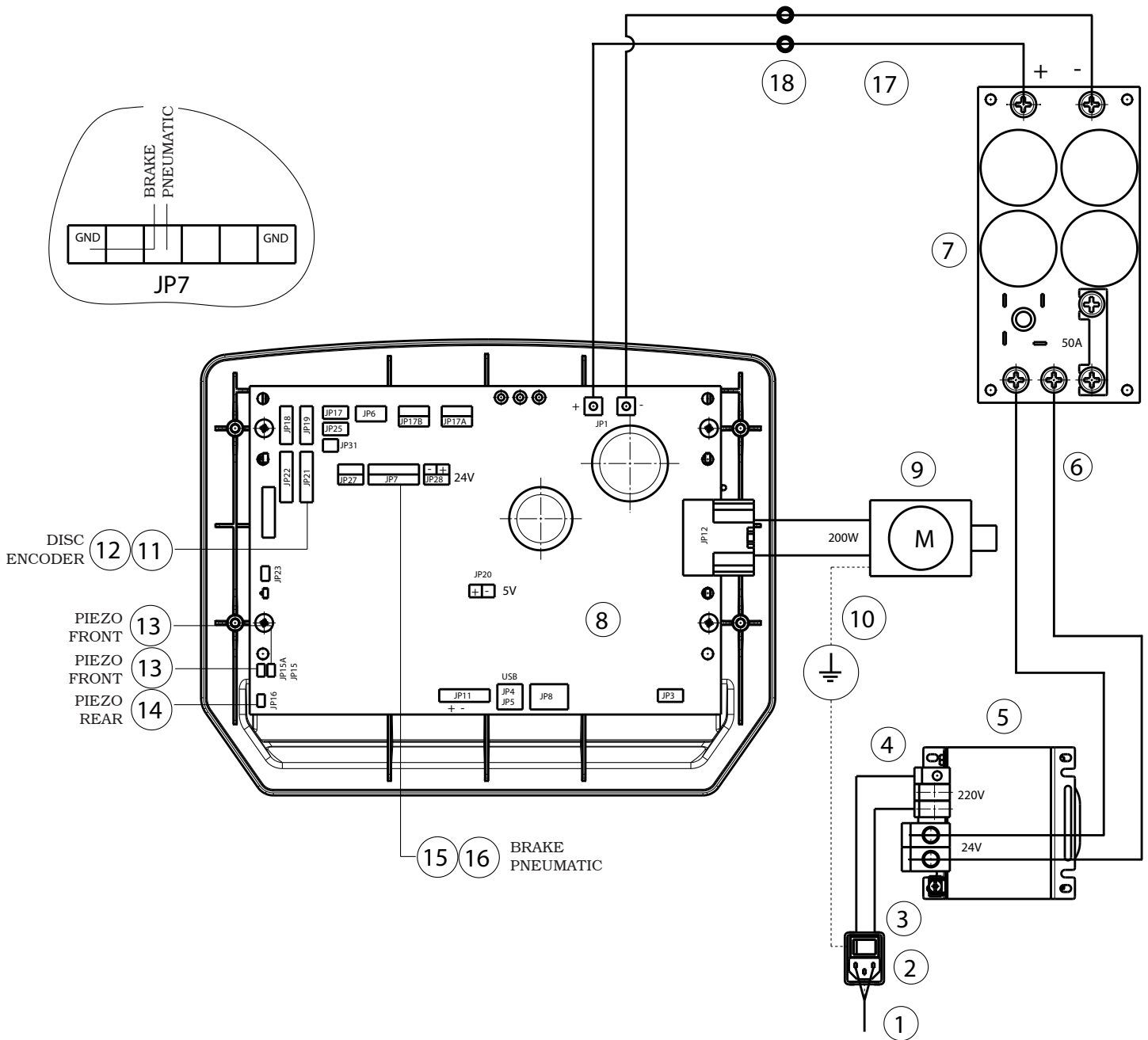
**Said plate must always be kept clean from grease residues or filth generally.**

*WARNING: Should the plate be accidentally damaged (removed from the machine, damaged or even partially illegible) inform immediately the manufacturer.*

## 29.0 FUNCTIONAL DIAGRAMS

Here follows a list of the machine functional diagrams.





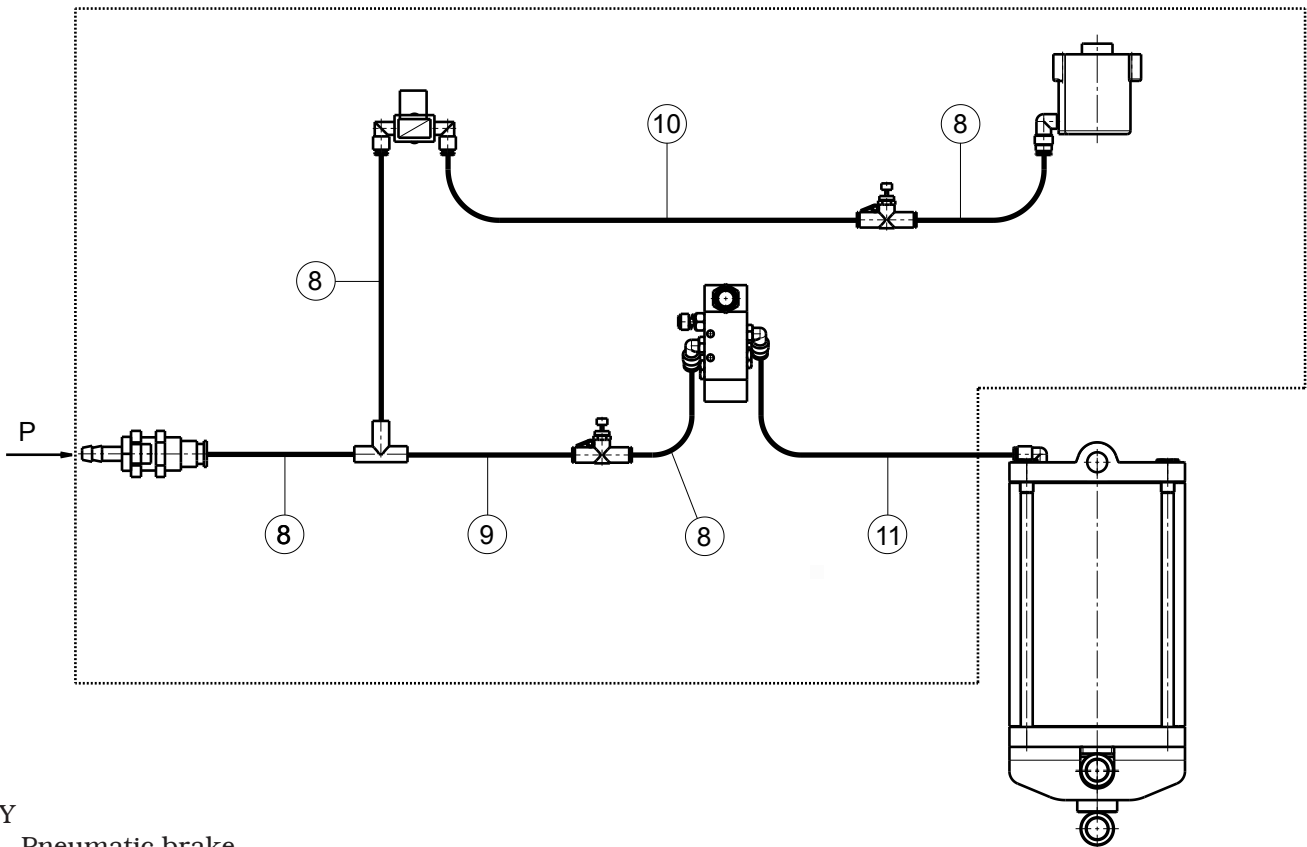
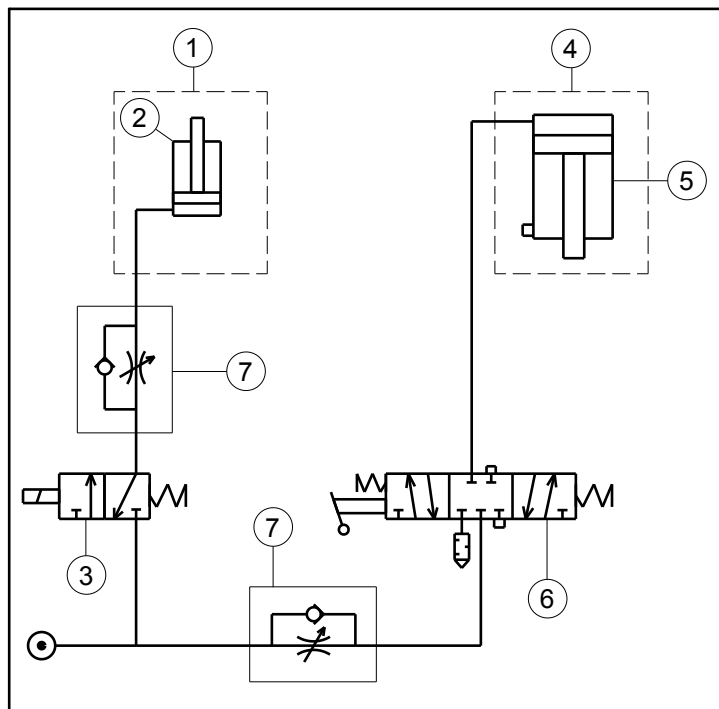
**KEY**

- |                                      |                                    |
|--------------------------------------|------------------------------------|
| 1 - Power supply cable               | 10 - Motor support ground cable    |
| 2 - Wired switch with plug           | 11 - Wheel position sensor cable   |
| 3 - Cable from switch to transformer | 12 - Buffered encoder board        |
| 4 - Fuse                             | 13 - Piezo with front cable        |
| 5 - Special transformer              | 14 - Piezo with cable              |
| 6 - Power card transformer cable     | 15 - Cable for solenoid valve SV-B |
| 7 - Power card                       | 16 - Mounting SV3                  |
| 8 - Display kit                      | 17 - Board cable extension         |
| 9 - Motor                            | 18 - Terminal                      |

GTL2.120NRC

**WIRING CONNECTION  
DIAGRAM**

1296-M020-0\_R



**KEY**

- 1 - Pneumatic brake
- 2 - Brake operating cylinder
- 3 - Pneumatic brake solenoid valve EV-B 3/2 NC
- 4 - Lifting device
- 5 - Lift operating cylinder
- 6 - Lever distributor 5/3 CC
- 7 - Unidirectional pneumatic reducer
- 8 - Rilsan Pipe 6x4 bl L=200
- 9 - Rilsan Pipe 6x4 bl L=350
- 10 - Rilsan Pipe 6x4 bl L=500
- 11 - Rilsan Pipe 6x4 bl L=700

GTL2.120NRC

**PNEUMATIC CONNECTION  
DIAGRAM**

1296-M020-0\_R



# Dichiarazione di Conformità

Declaration of Conformity  
Konformitätserklärung  
Déclaration de Conformité  
Declaración de Conformidad



Noi  
We / Wir / Nous / Nosotros

**RAVAGLIOLI S.p.A.**  
**via 1° Maggio, 3**  
**40037 Pontecchio Marconi (Bologna) – ITALIA**

### dichiariamo sotto la nostra esclusiva responsabilità che il prodotto

declare, undertaking sole responsibility, that the product  
erklären unter unserer alleinigen Verantwortung, dass das Produkt  
déclarons, sous notre entière responsabilité, que le produit  
declaramos bajo nuestra exclusiva responsabilidad, que el producto

<b>Equilibratrice</b> Wheel Balancer Auswuchtmaschine Équilibreuse de roue Equilibradora	
--	--

### al quale questa dichiarazione si riferisce, in base alle seguenti Direttive applicabili:

to which this declaration applies in compliance with the following applicable Directives:  
auf das sich diese Erklärung bezieht, in nachstehenden anwendbaren Normen entspricht:  
objet de cette déclaration est confor aux Directives applicables suivantes:  
al que se refiere esta declaración cumple con las siguientes Normas aplicables:

**2006/42/CE** Direttiva Macchine  
**2014/30/UE** Direttiva Compatibilità Elettromagnetica

### Per la conformità alle suddette direttive sono state seguite le seguenti Norme Armonizzate:

To comply with the above mentioned Directives, we have followed the following harmonized directives:  
In Übereinstimmung mit o.g. Richtlinien wurden folgende harmonisierte Normen befolgt:  
Pour la conformité aux normes ci-dessus, nous avons suivi les normes harmonisées suivantes:  
Para la conformidad a las Normas arriba mencionadas, hemos seguido las siguientes normas armonizadas:

**UNI EN ISO 12100:2010** Sicurezza del macchinario – Principi generali di progettazione – Valutazione del rischio e riduzione del rischio

**CEI EN 60204-1:2006/AC:2010** Sicurezza del macchinario – Equipaggiamento elettrico delle macchine – Parte 1: Regole generali

### La persona preposta a costituire il fascicolo tecnico è RAVAGLIOLI S.p.A.

The technical documentation file is constituted by RAVAGLIOLI S.p.A.  
Vorgesetzte Rechtsperson für die Erstellung des technischen Lastenheftes ist RAVAGLIOLI S.p.A.  
La société RAVAGLIOLI S.p.A. est l'organisme désigné à la présentation de la documentation technique.  
RAVAGLIOLI S.p.A. es encargata a la constitución del archivo técnico.

**RAVAGLIOLI S.p.A.**