

CASCOS

LIFTING PROFESSIONALS



4 POST LIFTS



C445H

Type	Ref.	Min	kg			
Hydraulic lifting table	13359	195 mm	4Tn-3.5Aux	1950 Kg.	230-400V/3ph/50Hz/3kW 230V/1ph/50Hz/2,2kW	40"

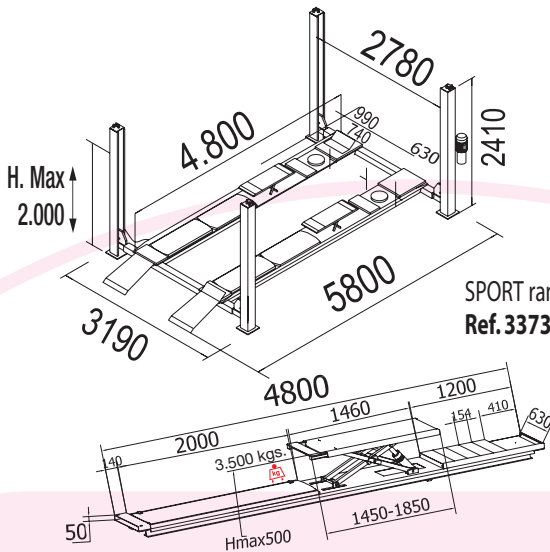

SPORT ramps available
Ref. 33730 - 1800 mm

With built in hydraulic lifting table.

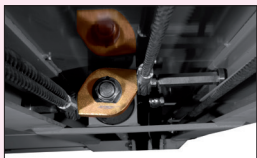
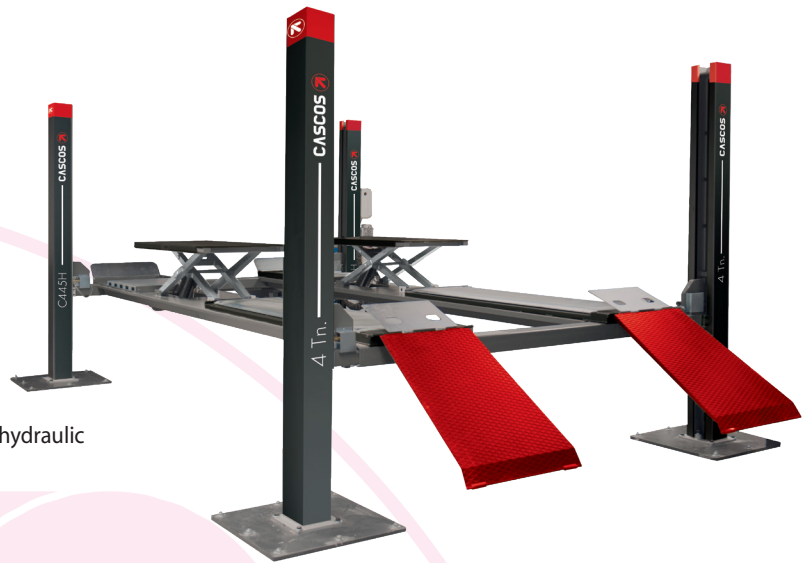

Security indicator

Indicator that prevents a bad levelling, and ensures that the cylinder works within the best conditions assuring a **longer lasting life**.



* See conditions

Warranty
5 YEARS*
Hydraulic

Hydraulic cylinders produced and tested one by one in our factory. The cylinders count with the security valves that **detects** any lack of oil, closing the circuit and preventing the lift from the descending.

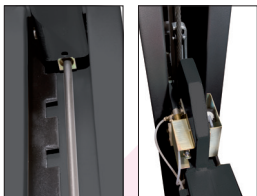

Security x2

Double security system in each post :

- **Mechanical** (safety bars)
- **Pneumatic** (security ladders)

Ensures a better reliability than the electromagnetic security system.

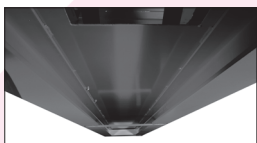

Our platforms are built with:

Reinforced super structure by double T steel beams for intensive use, keeping the platform flat/straight over the years.

Minimal height

Our platforms descend almost to the ground level avoiding the use of bulky run-up ramps to allow sport cars to go in (and consequently, using less garage area).

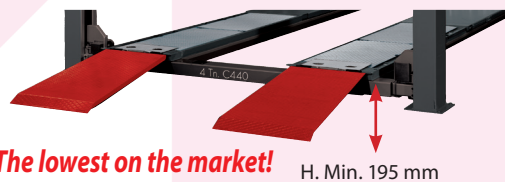

The lowest on the market!

H. Min. 195 mm

Alignment

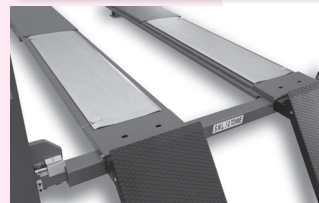

Alignment plates with the new **sliding bearings system**:

- More comfortable and sensitive to alignment.
- Manual lock in the center of the platform.

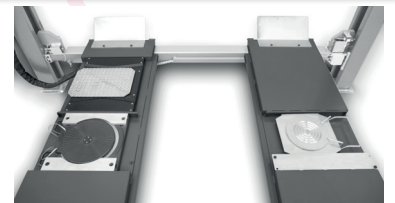

Recesses ready for alignment plates and / or turning plates 50 mm height. The lift includes Steel spacers for smaller turning plates.



Picture model C 442 (alignment)

VERSIONS WITH PLAY DETECTOR INTEGRATED

Lift includes play detector listed on VOSA accepted equipment, securely integrated on the platform designed with recesses to integrate turning plates and fix them in line with VOSA requirements.

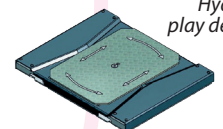

Hydraulic play detector

Repairable during at least 10 years.

We ensure spare parts availability during at least this period.



2006/42/CE & EN - 1493:2011
European Directives
& Approved Standards



OPTIONAL EQUIPMENT

Oleopneumatic Jacks

4 Tn

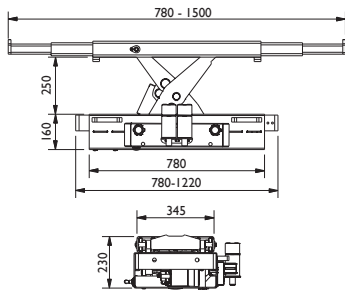
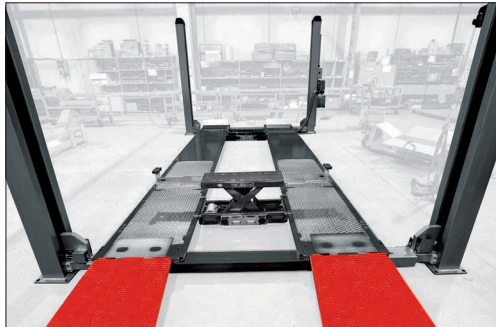

2 - 2,6 Tn

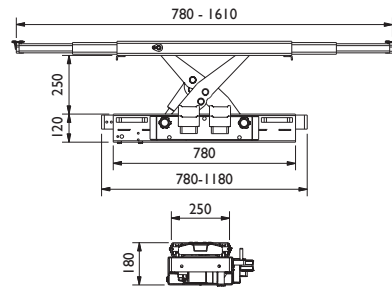

	Without lip
Capacity	Ref
2 Tn	50515
2,6 Tn	50517
4 Tn	50565

Accesories

Magnetic lighting kit

LED 24 V
Without installation

Ref.: 34053

Top Covers

Ref.: 32129

Magnetic holder for tools

Ref.: 26141

Magnetic air Kit

Ref.: 26177

Sport ramps kit

Ref.: 33730

Integrated power plug Assembled in factory

Ref.: 22164