

# Installation instructions

Transport refrigeration

Frigo Top 24 | 36 | 38 | 43 RT-D

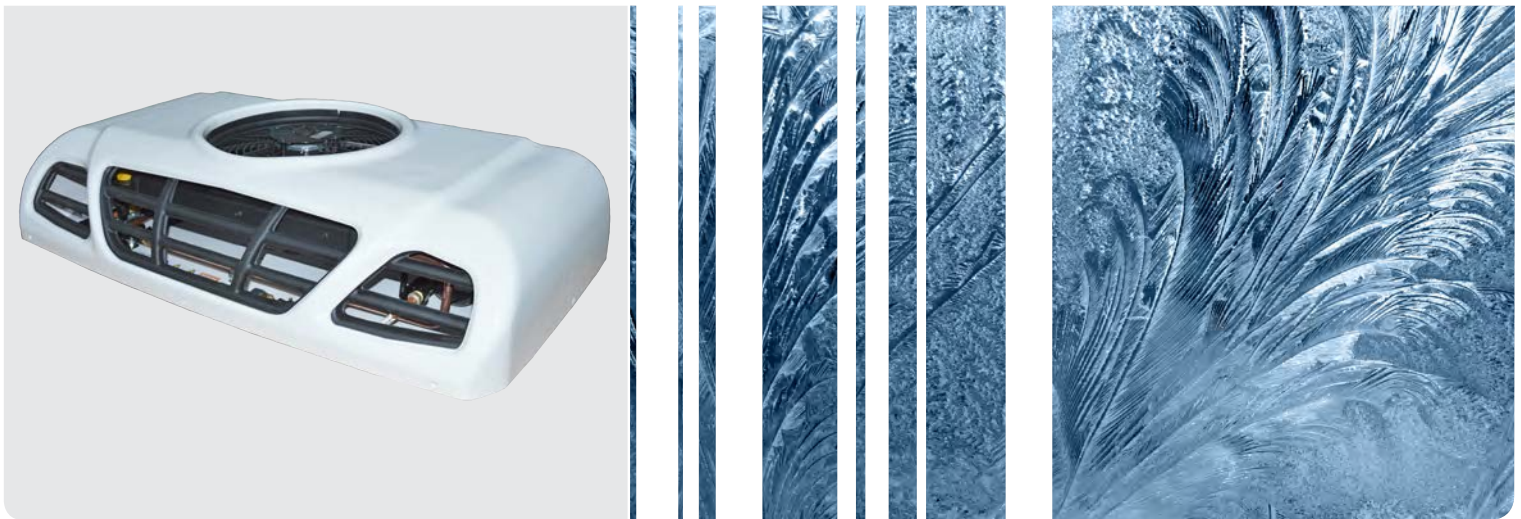

## English

Installation instructions are valid for:

- Frigo Top 24 RT-D 12V R134a
- Frigo Top 24 RT-D 12V R452A
  
- Frigo Top 36 RT-D 12V R404A
- Frigo Top 36 RT-D 12V R134a
- Frigo Top 36 RT-D 12V R452A
  
- Frigo Top 38 RT-D 12V R404A
  
- Frigo Top 43 RT-D 12V R452A
- Frigo Top 43 RT-D 12V R404A
  
- Frigo Top 43 RT-D 24V R452A
- Frigo Top 43 RT-D 24V R404A

# Content

<b>1</b>	<b>About this document</b>	<b>3</b>
1.1	Purpose of the document	3
1.2	Using this document	3
1.3	Use of symbols and highlighting	3
1.4	Necessary Tools	3
1.5	Warranty and liability	3
<b>2</b>	<b>Safety</b>	<b>4</b>
2.1	Intended use	4
2.2	Qualifications of installation personnel	4
2.3	Safety information	4
2.4	Safety information on operation	4
2.5	High pressure	4
<b>3</b>	<b>Scope of delivery</b>	<b>5</b>
3.1	Frigo Top 24 RT-D R134a / R452A	5
3.2	Frigo Top 36 RT-D R134a / R452A	6
3.3	Frigo Top 36 RT-D R404A	7
3.4	Frigo Top 38 RT-D R404A	8
3.5	Frigo Top 43 RT-D R404A / R452A	9
<b>4</b>	<b>Installation and handling</b>	<b>10</b>
4.1	Installation options	10
4.2	Optimal working range	10
4.3	Safe lifting of the Frigo Top 36 (R134a, R452A) / 38 / 43 (R404A, R452A)	10
<b>5</b>	<b>Frigo Top place on the vehicle</b>	<b>11</b>
5.1	Drilling holes	11
5.2	Which template to use	11
<b>6</b>	<b>Hose connections</b>	<b>17</b>
6.1	Frigo Top 24 RT-D R134a	17
6.2	Frigo Top 24 RT-D R452A	17
6.3	Frigo Top 36 RT-D R452A	17
6.4	Frigo Top 36 RT-D R134a	18
6.5	Frigo Top 36 RT-D R404A	18
6.6	Frigo Top 38 RT-D R404A	18
6.7	Frigo Top 43 RT-D R404A / R452A	19
6.8	Hose diagrams	19
<b>7</b>	<b>Install the compressor</b>	<b>21</b>
7.1	Fill the compressor with oil	21
<b>8</b>	<b>Crimp the hose to the fitting</b>	<b>22</b>
8.1	Cut hose and lubricate the O-rings	22
8.2	Insert the fitting	22
8.3	Tighten the clamp	22
<b>9</b>	<b>Hose lay-out in Frigo Top</b>	<b>23</b>
9.1	Frigo Top 24 RT-D	23
9.2	Frigo Top 36 RT-D	23
9.3	Frigo Top 38 RT-D	24
9.4	Frigo Top 43 RT-D	24
<b>10</b>	<b>Install control element</b>	<b>25</b>
10.1	Install control element in the dashboard	25
10.2	Install control element in a box	25
10.3	Connect the control element	25
<b>11</b>	<b>Vacuum and charge the system</b>	<b>26</b>
11.1	General procedure	26
11.2	Vacuum down the system	26
11.3	Fill the service station with oil	27
11.4	Charge the system with oil and refrigerant (R134a)	27
11.5	Charge the system with oil and refrigerant (R404A or R452A)	27
<b>12</b>	<b>Place the covers</b>	<b>29</b>
12.1	Frigo Top 24 (R134a / R452A) / 36 (R404A) Condenser	29
12.2	Frigo Top 36 (R134a / R452A) / 38 (R404A) / 43 (R404A / R452A) Condenser	29
<b>13</b>	<b>Initial operation</b>	<b>29</b>
<b>14</b>	<b>Technical data</b>	<b>30</b>
<b>15</b>	<b>Annex</b>	<b>31</b>
15.1	Frigo Top cable assignment	31
15.2	Frigo Top components	31
15.3	Cable colours	31
15.4	Symbols	32
15.5	Wiring diagram overview	32
15.6	Diagram Frigo Top 24 RT-D, 12 V, power circuit, (R134a, R452A)	33
15.7	Diagram Frigo Top 24 RT-D, 12 V, auxiliary, (R134a, R452A)	34
15.8	Diagram Frigo Top 36 RT-D, 12 V, power circuit, (R404A)	35
15.9	Diagram Frigo Top 36 RT-D, 12 V, auxiliary, (R404A)	36
15.10	Diagram Frigo Top 36 RT-D, 12 V, (R134a, R452A) 38 RT-D, 12 V, (R404A) 43 RT-D, 12-24 V, (R404A, R452A), power circuit	37
15.11	Diagram Frigo Top 36 RT-D, 12 V, (R134a, R452A) 38 RT-D, 12 V, (R404A) 43 RT-D, 12-24 V, (R404A, R452A), auxiliary	38

# 1 About this document





## 1.1 Purpose of the document

These installation instructions are an integral part of the product and contain all the information required to ensure correct and safe installation.





## 1.2 Using this document



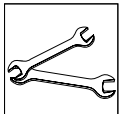

Before installing the unit, read the installation instructions.

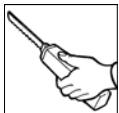
## 1.3 Use of symbols and highlighting

	Explanation
▶	Action to be taken
✓	Requirements for the following necessary action
	Note on a special technical feature
	Separate information is available
	Possibility on property damage
	Possibility on a severe or mortal injury

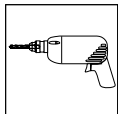
## 1.4 Necessary Tools

Tool	Description
	Lubricate all fittings and O-rings before connecting
	Equalize torsion couple by using 2 wrenches for tightening and losing fittings
	Knife
	Heated cutting device
	Mechanical cutting device
	Soldering iron
	File

Tool	Description
	Drill
	Silicon glue gun
	Safety glasses
	Safety gloves

Tbl. 01: Tools

## 1.5 Warranty and liability

Webasto shall not assume liability for defects or damage that are the result of the installation and operating instructions being disregarded.

- This liability exclusion particularly applies for:
  - Installation by untrained personnel
  - Improper use
  - Repairs not carried out by a Webasto service workshop
  - Use of non-original spare parts
  - Conversion of the unit without permission from Webasto

## 2 Safety

### 2.1 Intended use

The Frigo Top 24 | 36 | 38 | 43 RT-D is approved for cargo space refrigeration on vehicles according category N1 as defined by directive 2007/46/CE

*Vehicles designed and constructed for the carriage of goods and having a maximum mass not exceeding 3,5 tonnes*

### 2.2 Qualifications of installation personnel

The installation personnel must have the following qualifications:

- Successful completion of Webasto training
- Corresponding qualification for working on technical systems.
- Certified to work on refrigeration systems

### 2.3 Safety information

#### Safety information on installation

Danger posed by live parts

- ▶ Prior to installation, disconnect the vehicle from the voltage supply.
- ▶ Always comply with legal requirements.
- ▶ Observe data on type label.

Danger of lacerations on sharp edges

- ▶ Fit protectors on sharp edges.

### 2.4 Safety information on operation

#### Avoiding damage to property

Incorrect handling

- ▶ Protect the unit against mechanical stress (e.g. dropping, impacts or knocks).
- ▶ Do not place heavy objects on top of the unit.
- ▶ Do not step on the unit.

Cables damaged on sharp edges can cause short-circuits

- ▶ Fit protectors on sharp edges.

### 2.5 High pressure

The Frigo Top 24 | 36 | 38 | 43 RT-D has a built-in pressure switch set at 32 bar.

# 3 Scope of delivery

The package contains all parts for a correct installation.

The Frigo Top comes standard with:

- Frigo Top system
- Control unit
- Electrical parts (fuses and crimp terminals)



The hose kit is not part of the scope of delivery and need to be ordered separately. See the pricelist for part numbers.

The hose kit includes fittings.

## 3.1 Frigo Top 24 RT-D R134a / R452A



	Description
	Condenser (external)
	Cover for condenser (external)
	Bag with small parts for condenser
	Evaporator (internal)
	Evaporator cover (Internal)
	Bag with small parts for refrigerator
	Drilling templates
	Rubber studs, roof mount only
	Oil 250 ml
	Manuals Important safety instructions Operator instructions

	Description
	Control unit
	Housing for control unit
	Mounting parts for control unit
	Strip type fuse box, fuse and terminal
	Blade type fuse box, blade type
	Connector PACKARD 1
	Terminals

Tbl. 02: Scope of delivery, Frigo Top 24 RT-D

### 3.1.1 Hose kit

	Description
	Hoses
	Fittings

Tbl. 03: Hose kit

### 3.1.2 Optional parts

- De-Icing kit (For R452A only)
- Heating kit (For R452A only)

### 3.2 Frigo Top 36 RT-D R134a / R452A

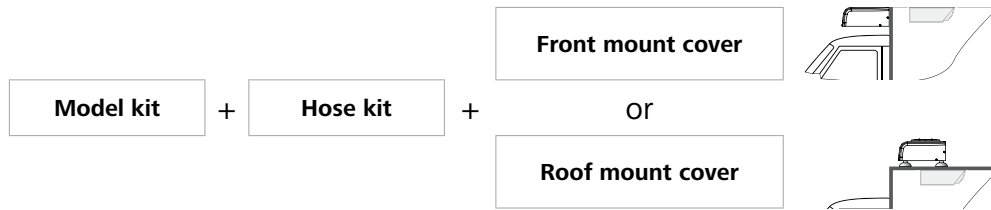

	Description
	Condenser (external)
	Bag with small parts for condenser
	Evaporator (internal)
	Evaporator cover
	Bag with small parts for refrigerator
	Drilling templates
	Oil 250 ml
	Manuals Important safety instructions Operator instructions
	Control unit
	Housing for control unit
	Mounting parts for control unit

	Description
	Strip type fuse box, fuse and terminal
	Blade type fuse box, blade type
	Connector PACKARD 1
	Terminals

Tbl. 04: Scope of delivery, Frigo Top 36 RT-D

#### 3.2.1 Cover

	Description
	Upper cover (external)
	Rubber studs, roof mount only

Tbl. 05: Scope of delivery, Cover Frigo Top 36 RT-D

#### 3.2.2 Hose kit

	Description
	Hoses
	Fittings









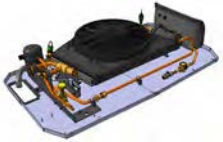

Tbl. 06: Hose kit



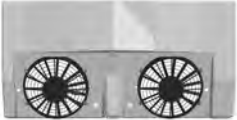

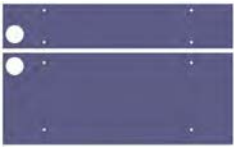

#### 3.2.3 Optional parts

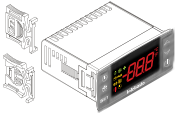
- De-Icing kit (For R452A only)
- Heating kit (For R452A only)

### 3.3 Frigo Top 36 RT-D R404A





	Description
	Condenser (external)
	Upper cover (external)
	Bag with small parts for condenser
	Evaporator (internal)
	Evaporator cover
	Bag with small parts for refrigerator
	Drilling templates
	Rubber studs, roof mount only
	Oil 250 ml
	Manuals Important safety instructions Operator instructions
	Control unit

	Description
	Housing for control unit
	Mounting parts for control unit
	Strip type fuse box, fuse and terminal
	Blade type fuse box, blade type
	Connector PACKARD 1
	Terminals

Tbl. 07: Scope of delivery, Frigo Top 36 RT-D

#### 3.3.1 Hose kit

	Description
	Hoses
	Fittings

Tbl. 08: Hose kit

#### 3.3.2 Optional parts

- De-Icing kit
- Heating kit



### 3.4 Frigo Top 38 RT-D R404A

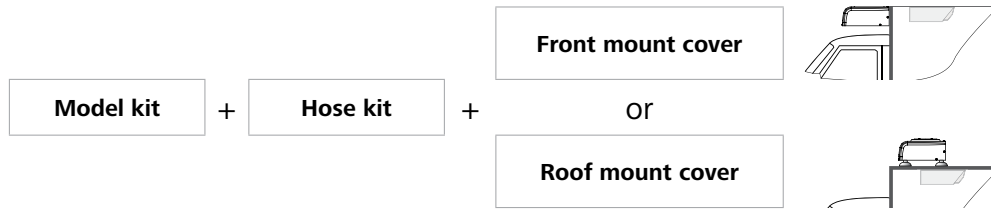

	Description
	Condenser (external)
	Bag with small parts for condenser
	Evaporator (internal)
	Evaporator cover
	Bag with small parts for refrigerator
	Drilling templates
	Oil 250 ml
	Manuals Important safety instructions Operator instructions
	Control unit
	Housing for control unit
	Mounting parts for control unit

	Description
	Strip type fuse box, fuse and terminal
	Blade type fuse box, blade type
	Connector PACKARD 1
	Terminals

Tbl. 09: Scope of delivery, Frigo Top 38 RT-D R404A

#### 3.4.1 Cover

	Description
	Upper cover (external)
	Rubber studs, roof mount only

Tbl. 10: Scope of delivery, Cover Frigo Top 38 RT-D

#### 3.4.2 Hose kit

	Description
	Hoses
	Fittings

Tbl. 11: Hose kit

#### 3.4.3 Optional parts

- De-Icing kit
- Heating kit



### 3.5 Frigo Top 43 RT-D R404A / R452A

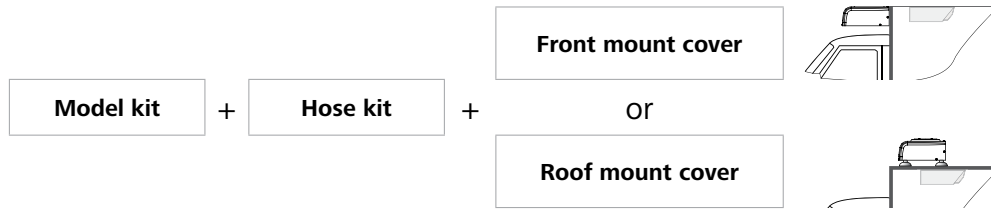

	Description
	Condenser (external)
	Bag with small parts for condenser
	Evaporator (internal)
	Evaporator cover
	Bag with small parts for refrigerator
	Drilling templates
	Oil 250 ml
	Manuals Important safety instructions Operator instructions
	Control unit
	Housing for control unit
	Mounting parts for control unit

	Description
	Strip type fuse box, fuse and terminal
	Blade type fuse box, blade type
	Connector PACKARD 1
	Terminals

Tbl. 12: Scope of delivery, Frigo Top 43 RT-D

#### 3.5.1 Cover

	Description
	Upper cover (external)
	Rubber studs, roof mount only

Tbl. 13: Scope of delivery, Cover Frigo Top 43 RT-D

#### 3.5.2 Hose kit

	Description
	Hoses
	Fittings

Tbl. 14: Hose kit

#### 3.5.3 Optional parts

- De-icing kit
- Heating kit

# 4 Installation and handling

## 4.1 Installation options

There are two options to install the Frigo Top condenser.

- Roof mount
- Front mount

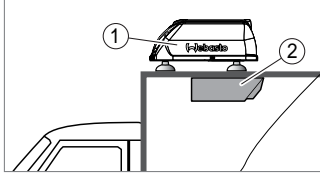

Fig. 01: Roof mount

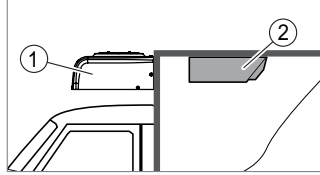

Fig. 02: Front mount

1. Condenser
2. Evaporator

Tbl. 15 shows the possible mounting options for the Frigo Top models.

Model	Roof mount	Front mount
Frigo Top 24 RT-D	Yes	No
Frigo Top 36 RT-D R404A	Yes	No
Frigo Top 36 RT-D R134a / R452A	Yes	Yes
Frigo Top 38 RT-D	Yes	Yes
Frigo Top 43 RT-D	Yes	Yes

Tbl. 15: Frigo Top mount options

## 4.2 Optimal working range

The refrigeration system works optimal when the vehicle is placed within the ranges shown in the images below.

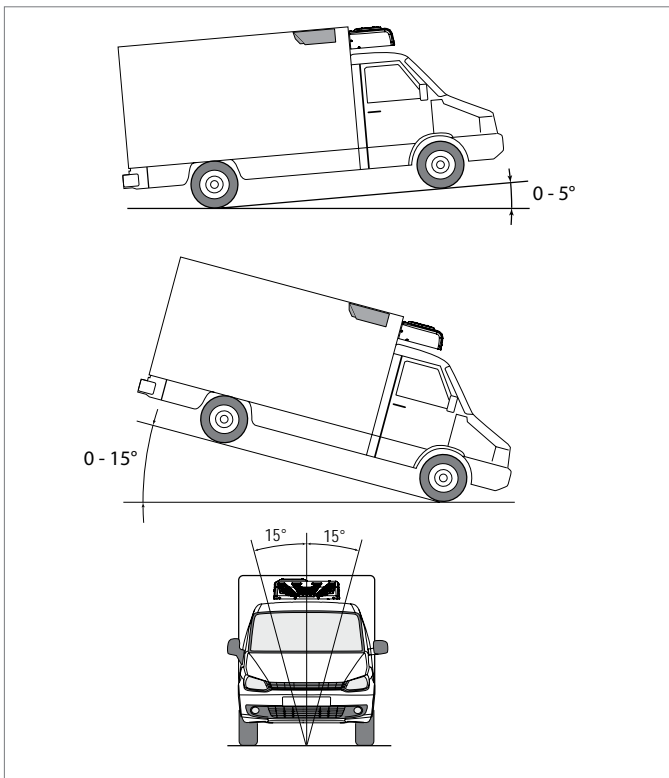

Fig. 03: Frigo Top working ranges (Top mount and Roof mount)

## 4.3 Safe lifting of the Frigo Top 36 (R134a, R452A) / 38 / 43 (R404A, R452A)

Make sure to lift the Frigo Top only at points located at the corners of the frame. See Fig. 04 and Fig. 05

- Use threaded shackles.
- Make sure the chain has a minimum length of 0,6 meter.

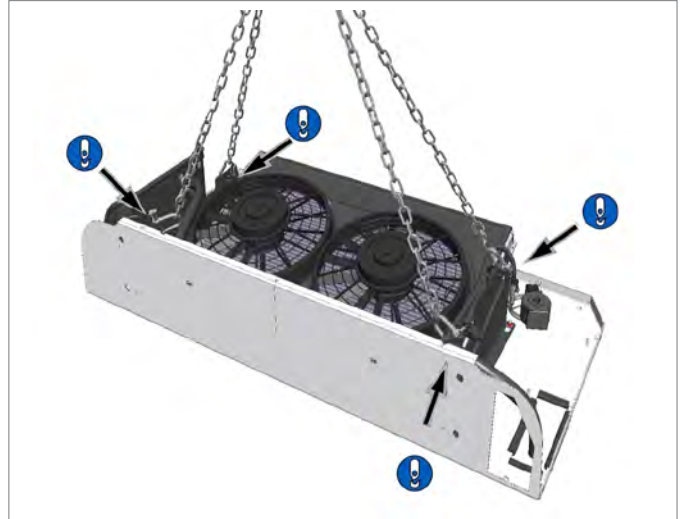

Fig. 04: Lift Frigo Top 36 Condenser R134a

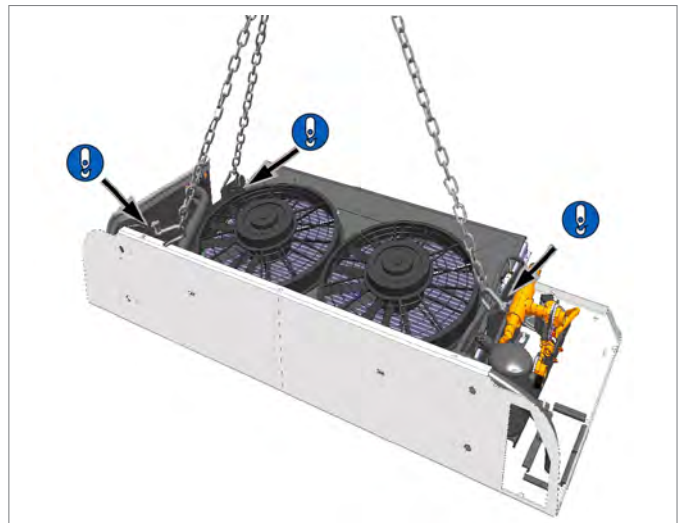

Fig. 05: Lift Frigo Top 36 / 38 / 43 Condenser (R404A, R452A)

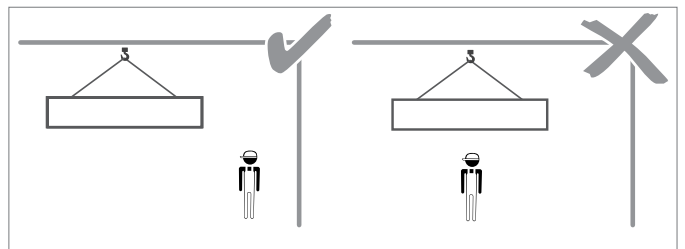

Fig. 06: Do not stand under lifted load

# 5 Frigo Top place on the vehicle

## 5.1 Drilling holes



### ATTENTION

Incorrectly chosen location of the Frigo Top condenser and evaporator

Result: Damage of components incorporate in wall and roof of the cooling compartment. e.g. wiring for lights

- ▶ Follow instructions given by the vehicle manufacturer.
- ▶ Check wall and roof before drilling holes

The drilling templates need to be aligned on the vehicle.

- ▶ Locate the place for the evaporator and condenser.
- ▶ Align templates.
- ▶ Drill the holes according template.

### 5.1.1 Roof mount, required parts

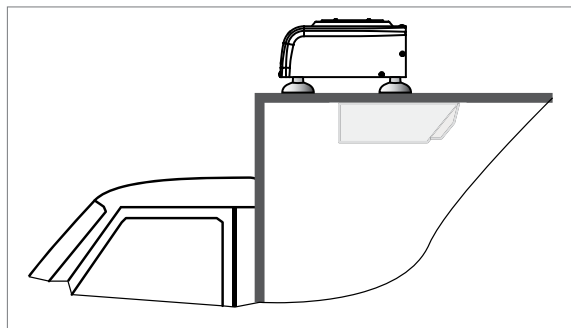





Fig. 07: Frigo Top 24 / 36 / 38 / 43 roof mount, rubber studs

The parts listed in Tbl. 16 are valid for all Frigo Top models

- ▶ Place the 4 rubber studs between roof and condenser unit.

	Description
	Rubber stud (4x)
	Hex bolt M10x150 (4x)
	Washer 12x30x2 (8x)
	Nut, self locking M10 (4x)

Tbl. 16: Parts roof mount

### 5.1.2 Front mount, required parts

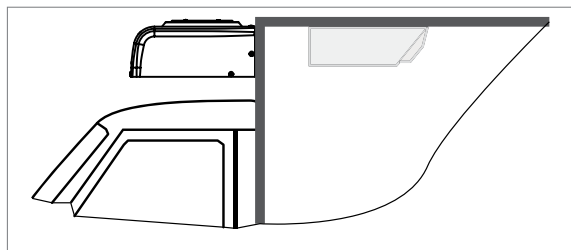





Fig. 08: Frigo Top 36 / 38 / 43 roof mount, rubber studs

The parts listed in Tbl. 17 are valid for all Frigo Top models (except Frigo Top 24 RT-D)

	Description
	Hex bolt M10x150 (4x)
	Washer 12x30x2 (8x)
	Nut, self locking M10 (4x)

Tbl. 17: Parts front mount

## 5.2 Which template to use

Model	Mount	Refrigerant	Drilling dimension	
			Condenser	Evaporator
Frigo Top 24 RT-D	Roof	R134a / R452A	„Fig. 09“ page 12	
Frigo Top 36 RT-D	Roof	R134a / R452A	„Fig. 10“ page 13	
Frigo Top 36 RT-D	Roof	R404A	„Fig. 13“ page 15	
Frigo Top 38 RT-D	Roof	R404A	„Fig. 10“ page 13	
Frigo Top 43 RT-D	Roof	R404A / R452A	„Fig. 14“ page 16	
Frigo Top 36 RT-D	Front	R134a / R452A	„Fig. 11“ page 14	„Fig. 12“ page 14
Frigo Top 38 RT-D	Front	R404A	„Fig. 11“ page 14	„Fig. 12“ page 14
Frigo Top 43 RT-D	Front	R404A / R452A	„Fig. 11“ page 14	„Fig. 12“ page 14

## 5.2.1 Frigo Top 24 RT-D, roof mount

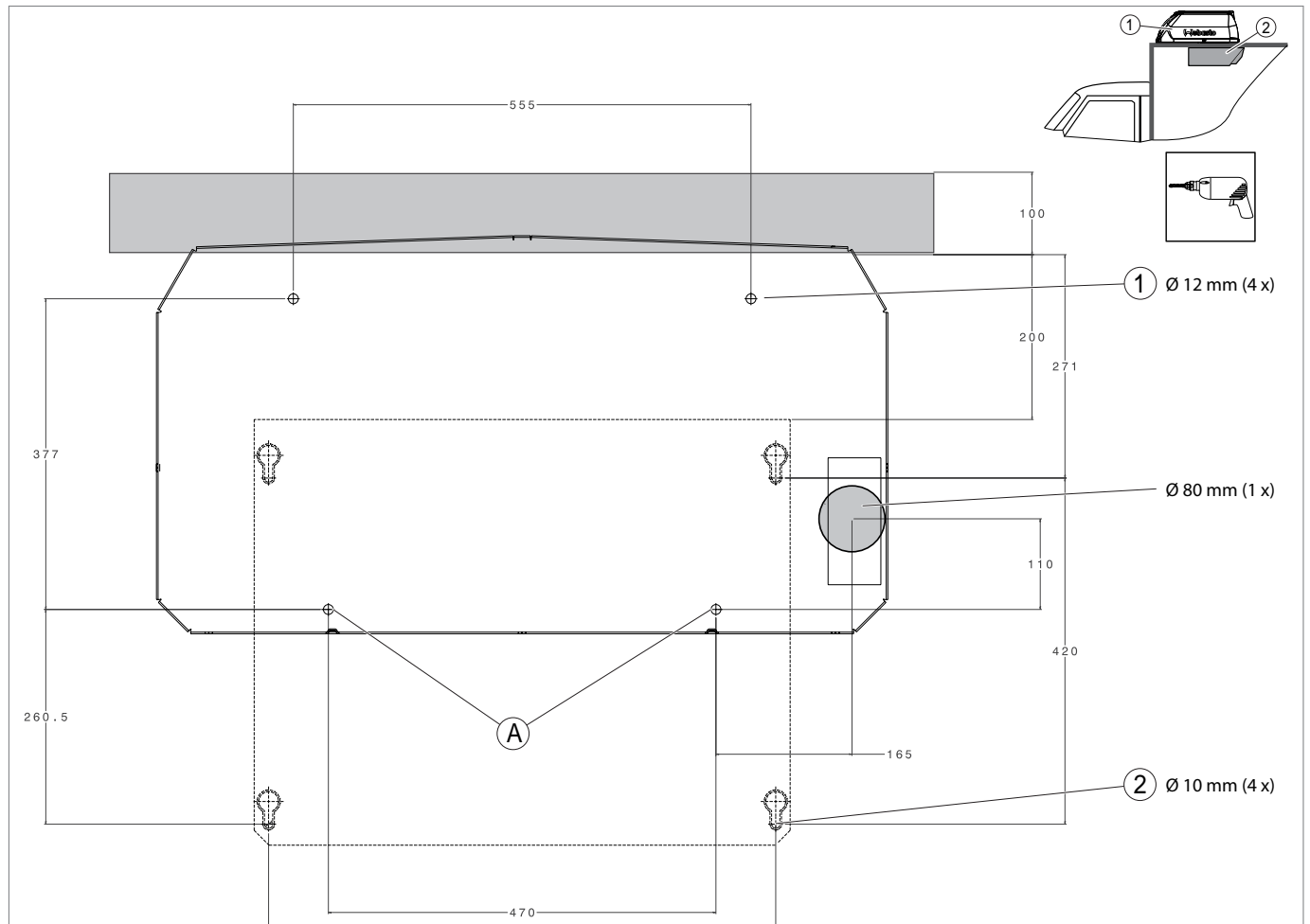







Fig. 09: Frigo Top 24 RT-D, roof mount

A = Common fixing point

### 1. Condenser

	Description
	Rubber stud (4x)
	Hex bolt M10x150 (4x)
	Washer 12x30x2 (8x)
	Nut, self locking M10 (4x)

### 2. Evaporator

	Description
	Screw 6x25 mm (5x)
	Washer 6x18x2 INOX A2 DIN9021 (5x)

## 5.2.2 Frigo Top 36 RT-D (R134a / R452A), 38, roof mount

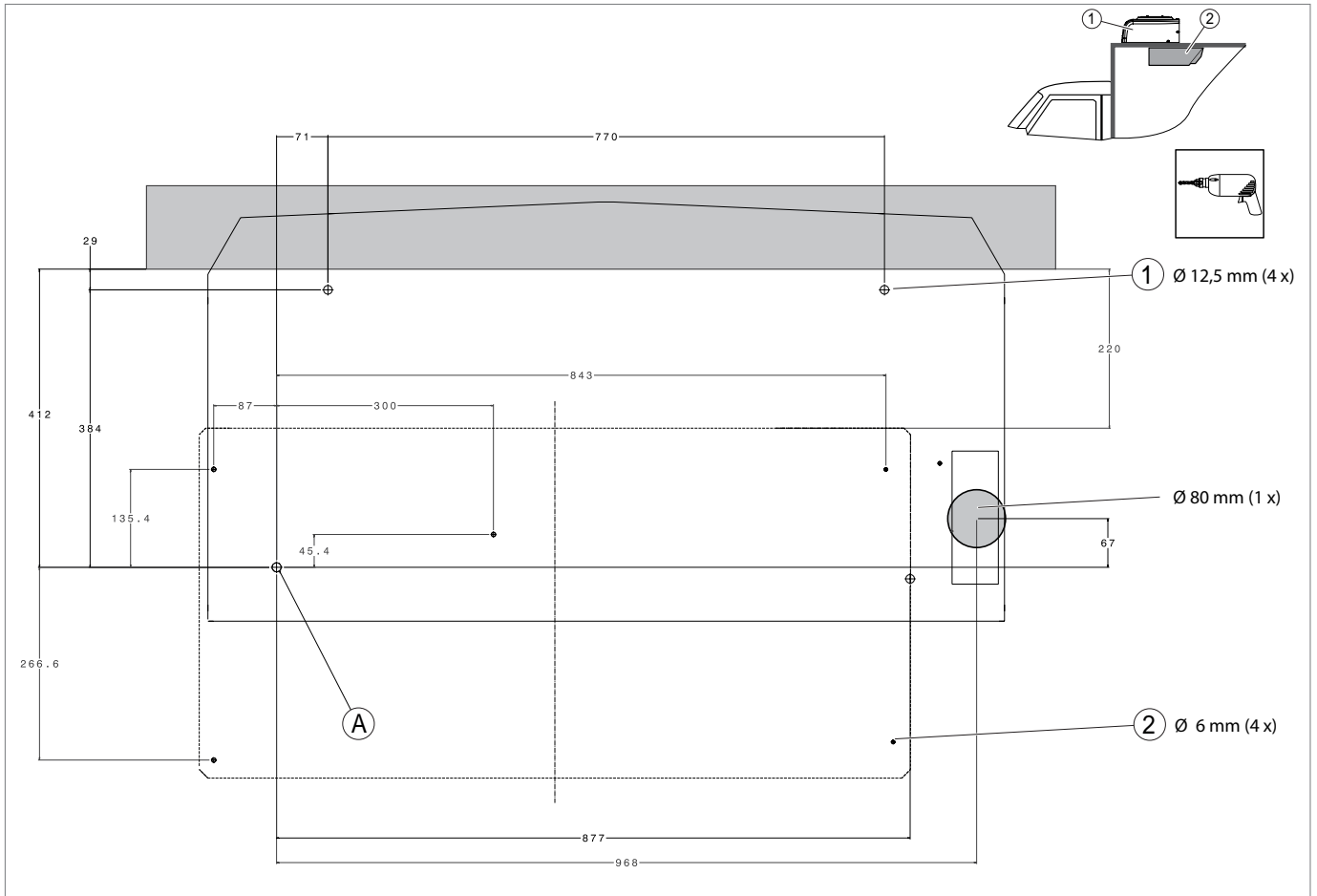







Fig. 10: Frigo Top 36 RT-D, roof mount

A = Common fixing point

### 1. Condenser

	Description
	Rubber stud (4x)
	Hex bolt M10x150 (4x)
	Washer 12x30x2 (8x)
	Nut, self locking M10 (4x)

### 2. Evaporator

	Description
	Screw 6x25 mm (5x)
	Washer 6x18x2 INOX A2 DIN9021 (5x)

## 5.2.3 Frigo Top 36 RT-D (R134a / R452A) / 38 / 43, condenser front mount

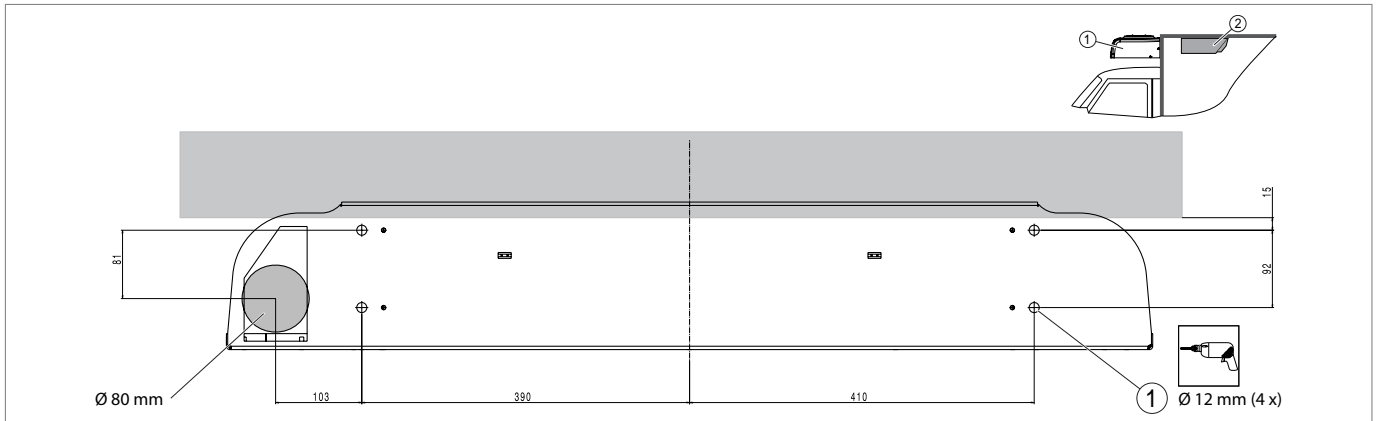

Fig. 11: Frigo Top 36 RT-D, condenser front mount

### 1. Condenser

	Description
	Hex bolt M10x150 (4x)
	Washer 12x30x2 (8x)
	Nut, self locking M10 (4x)

## 5.2.4 Frigo Top 36 (R134a / R452A) 38, evaporator mount

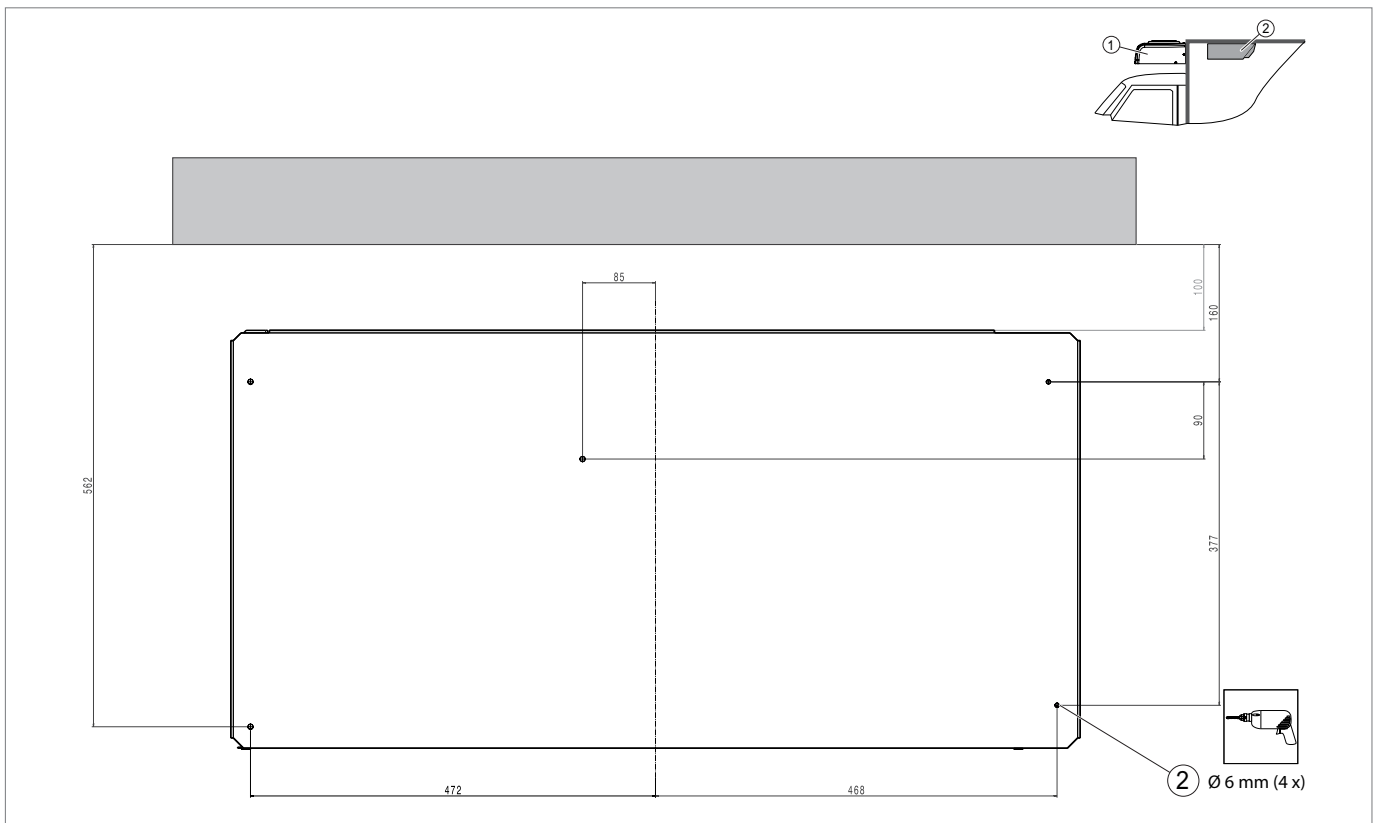

Fig. 12: Frigo Top 36 (R134a / R452A) 38, evaporator mount

### 2. Evaporator

	Description
	Screw 6x25 mm (5x)
	Washer 6x18x2 INOX A2 DIN9021 (5x)

## 5.2.5 Frigo Top 36 RT-D, R404A, roof mount

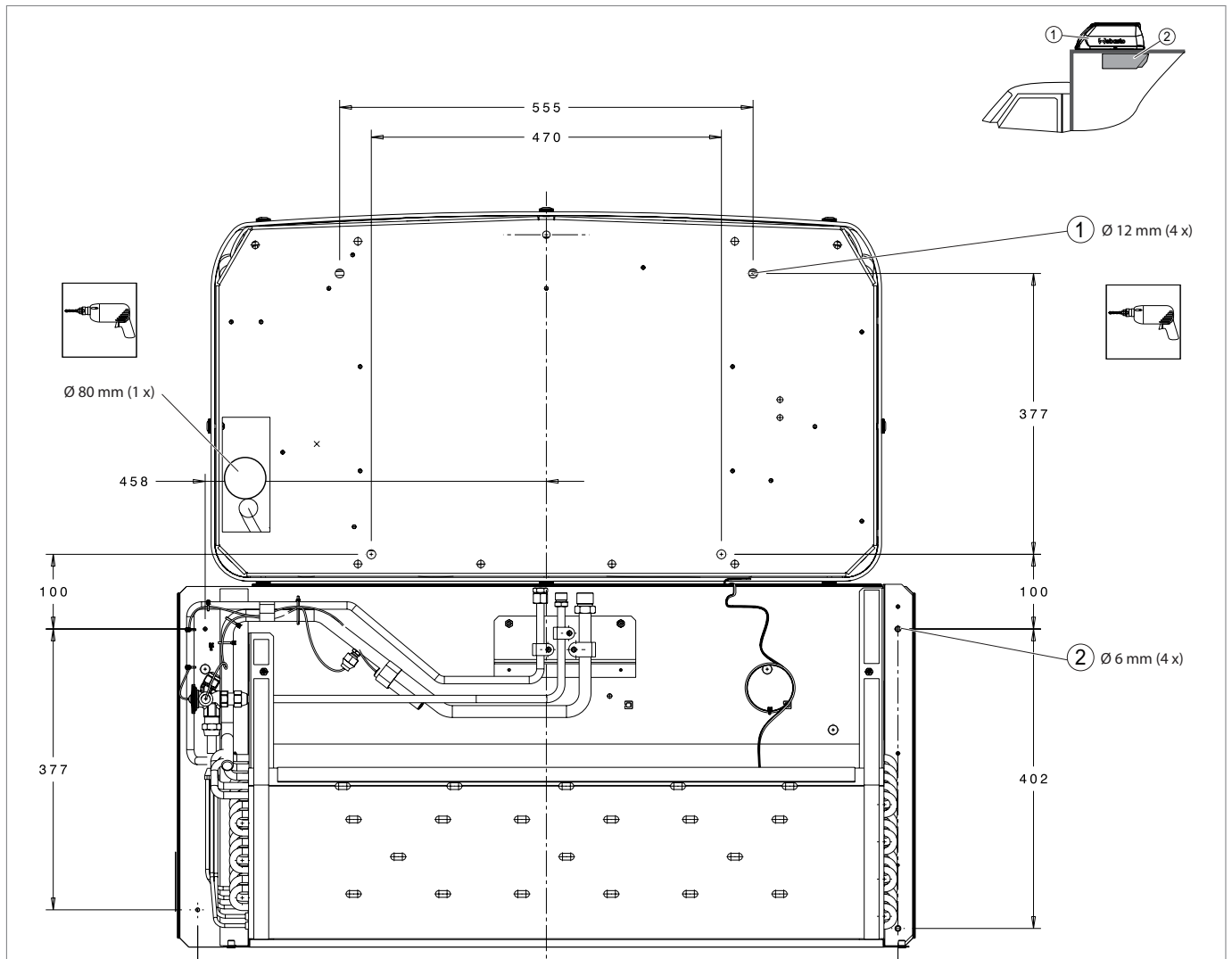







Fig. 13: Frigo Top 36 RT-D, R404A, roof mount

### 1. Condenser

	Description
	Rubber stud (4x)
	Hex bolt M10x150 (4x)
	Washer 12x30x2 (8x)
	Nut, self locking M10 (4x)

### 2. Evaporator

	Description
	Screw 6x25 mm (5x)
	Washer 6x18x2 INOX A2 DIN9021 (5x)



## 5.2.6 Frigo Top 43 RT-D,(R404A / R452A), roof mount

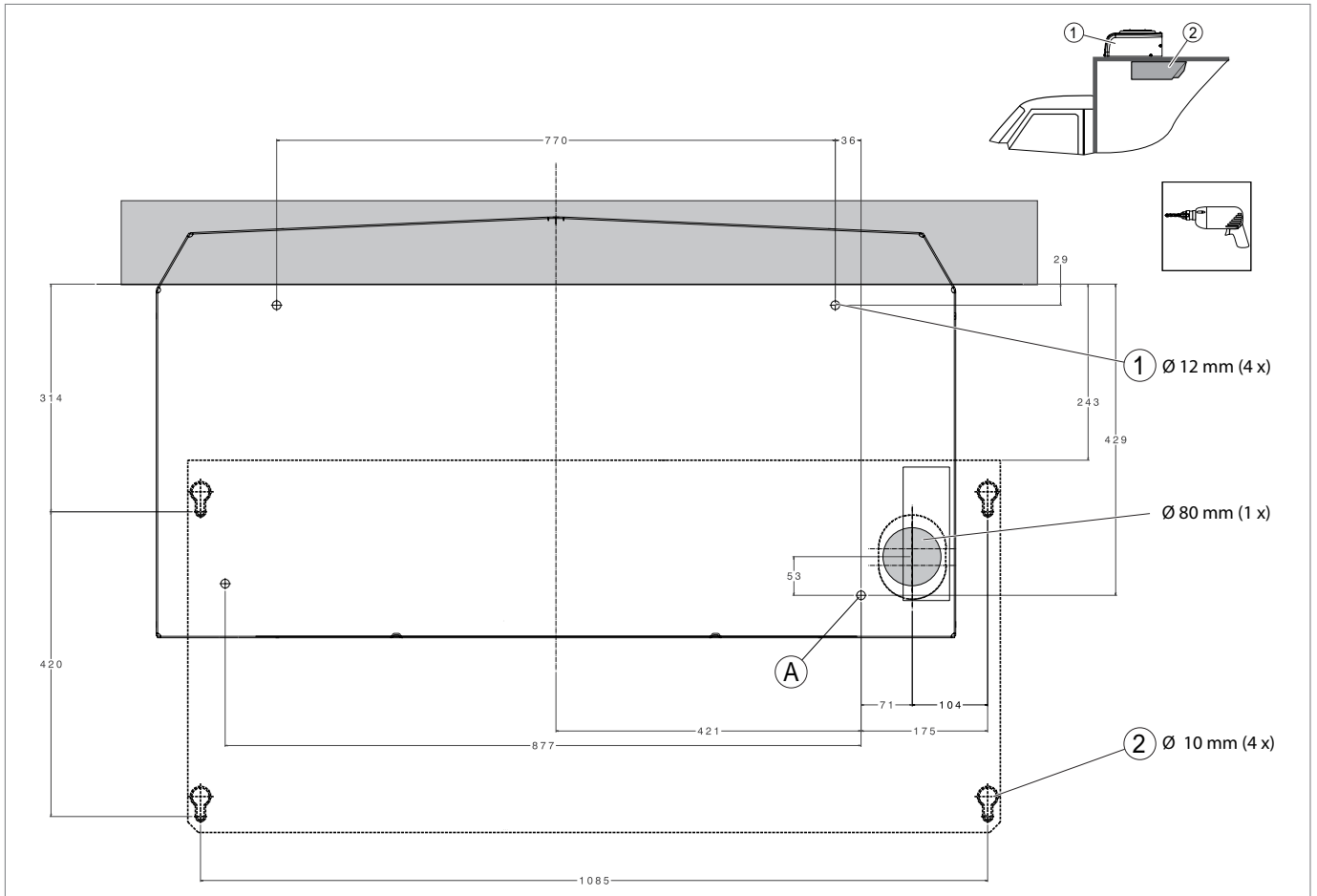







Fig. 14: Frigo Top 43 RT-D roof mount

A = Common fixing point

### 1. Condenser

	Description
	Rubber stud (4x)
	Hex bolt M10x150 (4x)
	Washer 12x30x2 (8x)
	Nut, self locking M10 (4x)

### 2. Evaporator

	Description
	Screw 6x25 mm (5x)
	Washer 6x18x2 INOX A2 DIN9021 (5x)

## 6 Hose connections

### 6.1 Frigo Top 24 RT-D R134a

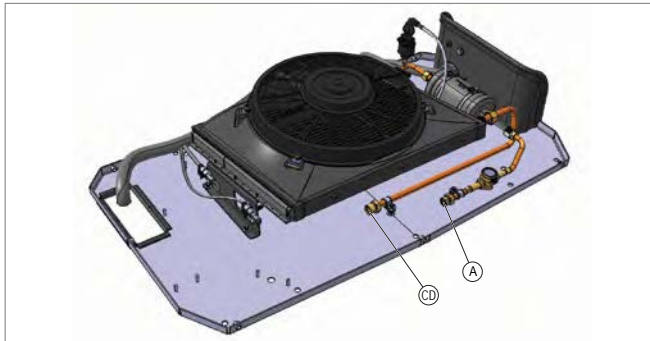

Fig. 15: Frigo Top 24 RT-D, Connections, condenser R134a

- A Liquid line
- E Defrost (closed on R134a)
- CD Compressor discharge
- B = CS Compressor suction

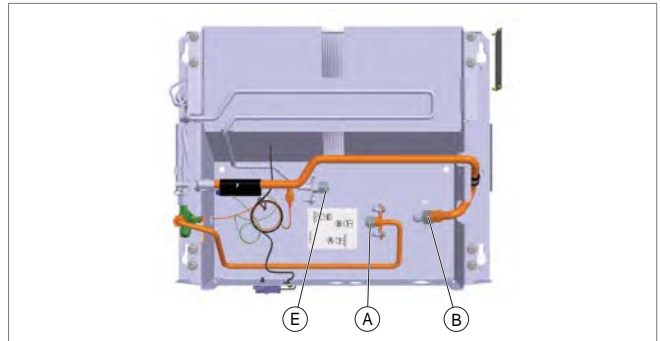

Fig. 16: Frigo Top 24 RT-D, Connections, evaporator R134a

### 6.2 Frigo Top 24 RT-D R452A

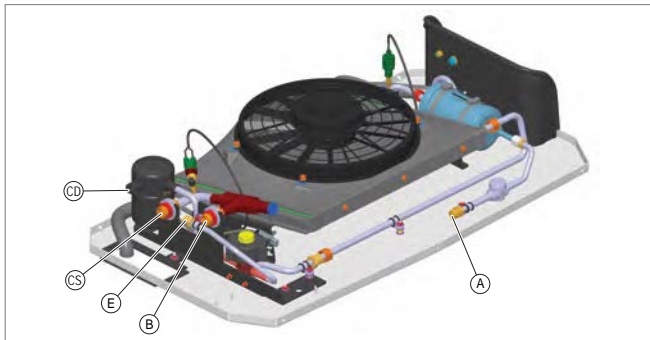

Fig. 17: Frigo Top 24 RT-D, Connections, condenser R452A

- A Liquid line
- B CRO inlet = evaporator outlet
- E Defrost line
- CD Compressor discharge = oil separator inlet
- CS Compressor suction

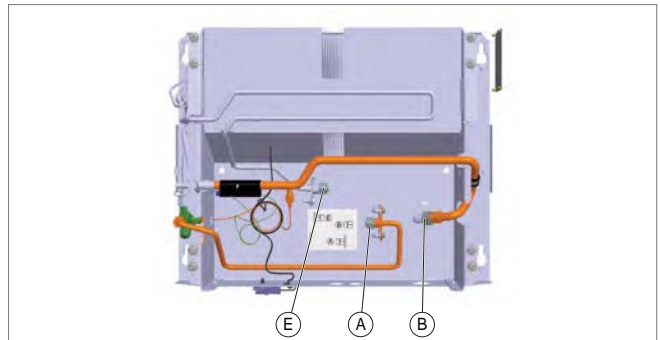

Fig. 18: Frigo Top 24 RT-D, Connections, evaporator R452A

### 6.3 Frigo Top 36 RT-D R452A

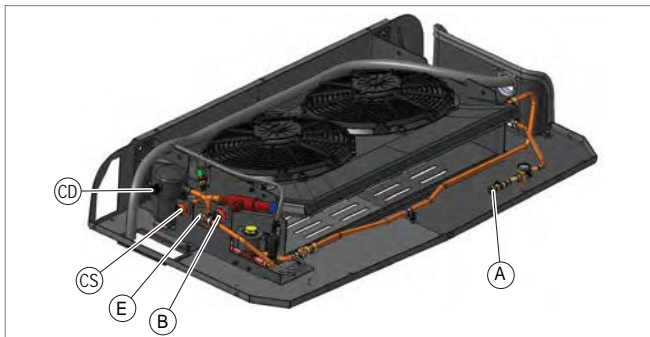

Fig. 19: Frigo Top 36 RT-D Connections, condenser R452A

- A Liquid line
- B CRO inlet = evaporator outlet
- E Defrost line
- CD Compressor discharge = oil separator inlet
- CS Compressor suction

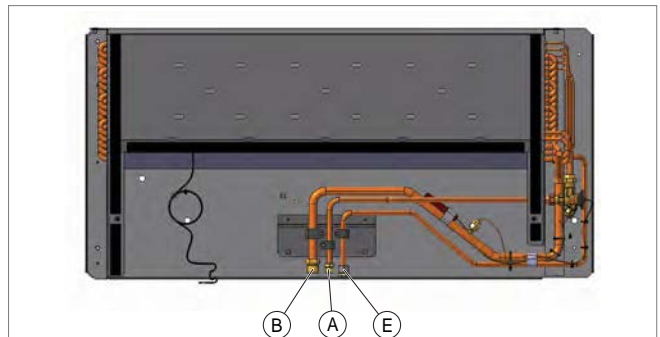

Fig. 20: Frigo Top 36 RT-D Connections, evaporator R452A

## 6.4 Frigo Top 36 RT-D R134a

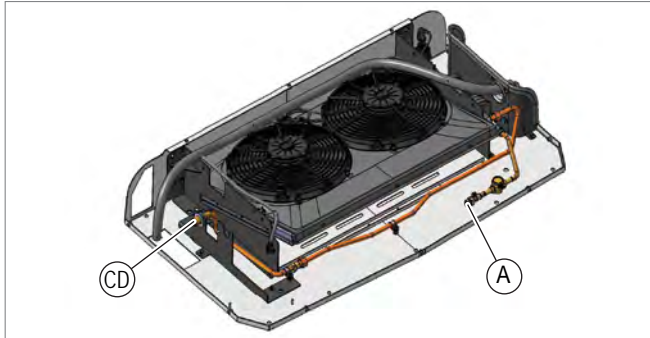

Fig. 21: Frigo Top 36 RT-D Connections, condenser R134a

- A Liquid line
- E Defrost (closed on R134a)
- CD Compressor discharge
- CS Compressor suction

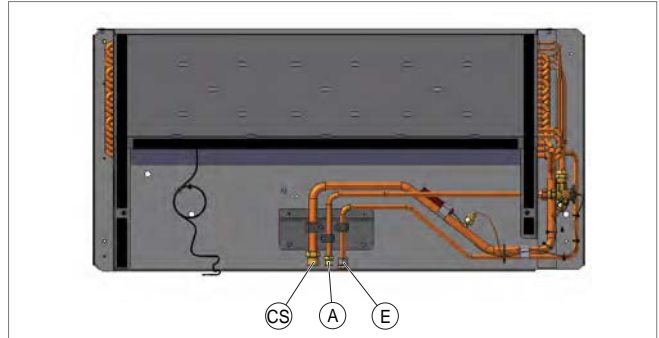

Fig. 22: Frigo Top 36 RT-D Connections, evaporator R134a

## 6.5 Frigo Top 36 RT-D R404A

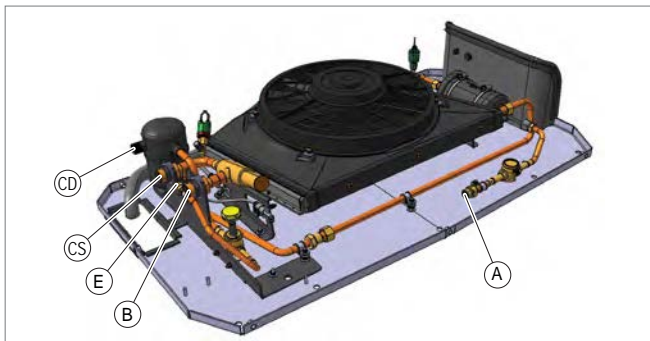

Fig. 23: Frigo Top 36 RT-D Connections, condenser R404A

- A Liquid line
- B CRO inlet = evaporator outlet
- E Defrost line
- CD Compressor discharge = oil separator inlet
- CS Compressor suction

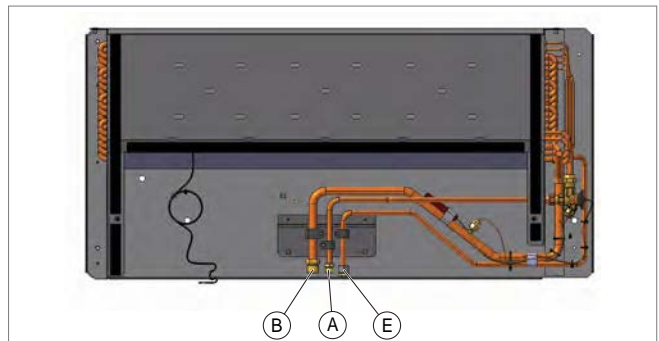

Fig. 24: Frigo Top 36 RT-D Connections, evaporator R404A

## 6.6 Frigo Top 38 RT-D R404A

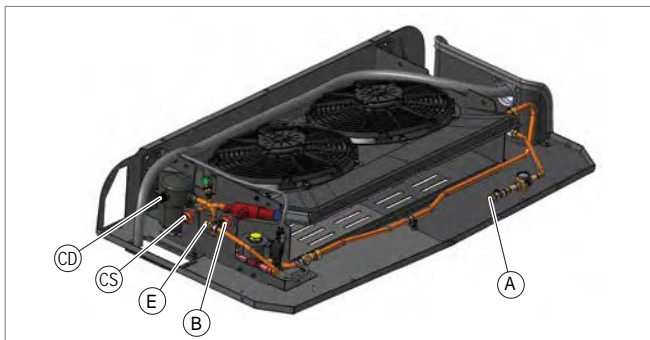

Fig. 25: Frigo Top 38 RT-D Connections, condenser R404A

- A Liquid line
- B CRO inlet = evaporator outlet
- E Defrost line
- CD Compressor discharge = oil separator inlet
- CS Compressor suction

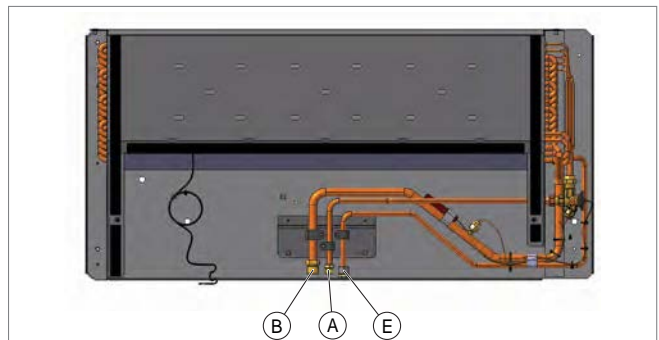

Fig. 26: Frigo Top 38 RT-D Connections, evaporator R404A

## 6.7 Frigo Top 43 RT-D R404A / R452A

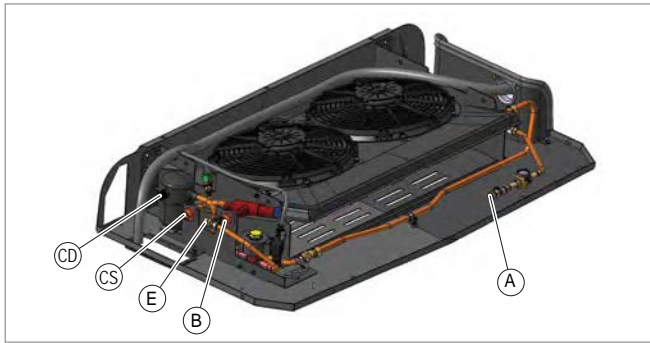

Fig. 27: Frigo Top 43 RT-D Connections, condenser R404A / R452A

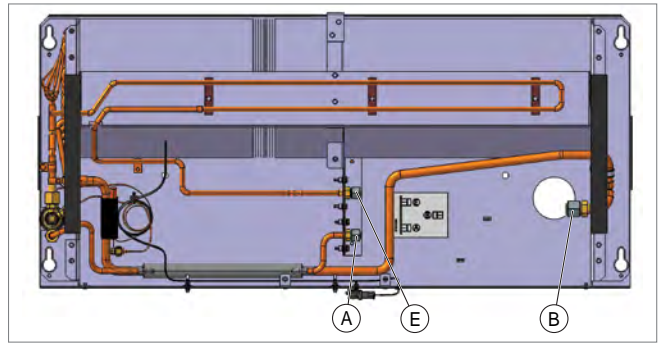

Fig. 28: Frigo Top 43 RT-D Connections, evaporator R404A / R452A

- A Liquid line
- B CRO inlet = evaporator outlet
- E Defrost line
- CD Compressor discharge = oil separator inlet
- CS Compressor suction

## 6.8 Hose diagrams

### 6.8.1 Frigo Top 24 / 36 R134a

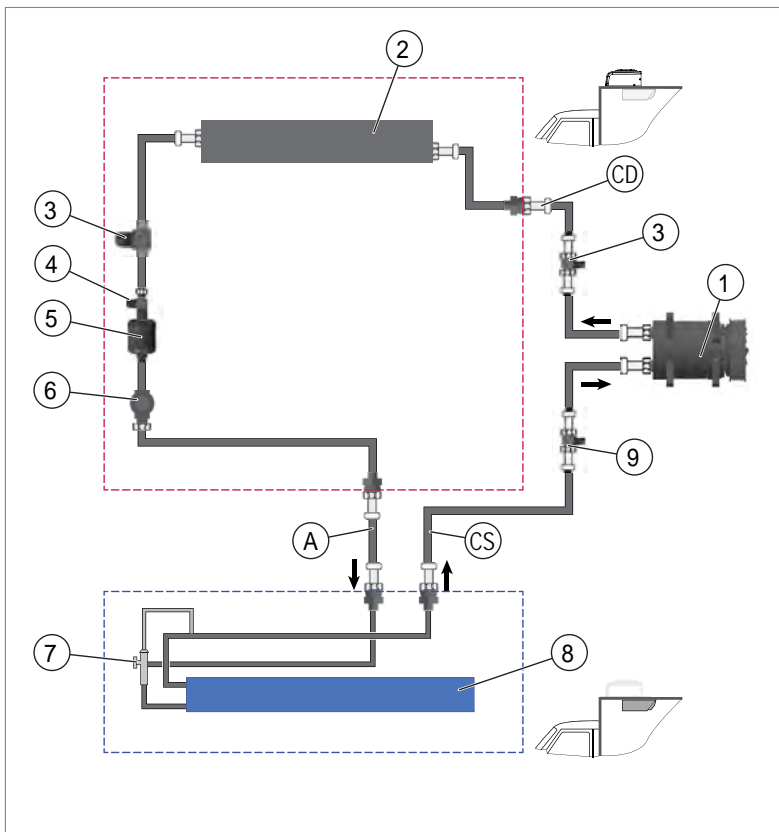

Fig. 29: Diagram Frigo Top 24 / 36, R134a

Ref	Description
1	Compressor
2	Condenser
3	Service port, High pressure (2x)
4	High- and Low-pressure switch
5	Liquid receiver & Filter dryer / Charge point
6	Sight glass
7	Thermostatic expansion valve (TXV)
8	Evaporator
9	Service port, Low pressure
A	Liquid line
CS	Compressor suction

## 6.8.2 Frigo Top 43 (R404A / R452A)

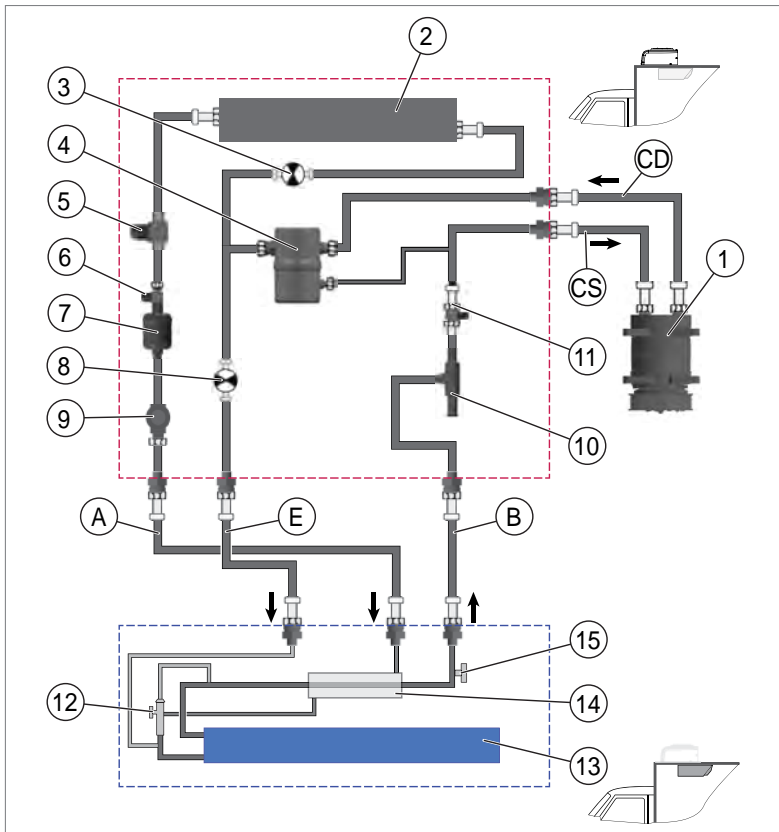

Fig. 30: Diagram Frigo Top 43 (R404A / R452A)

Ref	Description
1	Compressor
2	Condenser
3	Heating valve (NO) <sup>1</sup> - Option
4	Oil separator
5	Service point, high-pressure side
6	High-pressure switch
7	Liquid receiver & Filter dryer / Charge point
8	Defrost valve (NC) <sup>2</sup>
9	Sight glass
10	Pressure regulator (CRO) <sup>3</sup>
11	Service port, Low pressure
12	Thermostatic expansion valve (TXV)
13	Evaporator
14	Internal heat exchanger
15	Service port, Low pressure
A	Liquid line
B	Evaporator outlet
E	Defrost line
CD	Compressor discharge = oil separator inlet
CS	Compressor suction

1. NO = Normally open
2. NC = Normally closed
3. CRO = Close on rise of outlet pressure

## 6.8.3 Frigo Top 24 (R452A) / 36 (R404A / R452A) / 38 (R404A)

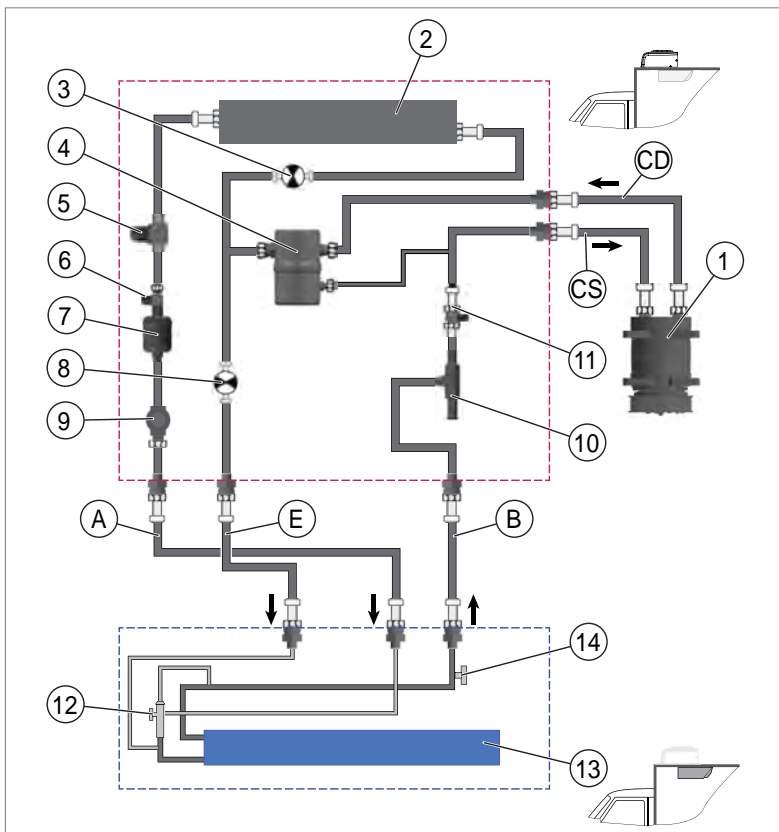

Fig. 31: Diagram Frigo Top 24 (R452A) / 36 (R404 A/R452A) / 38 (R404A)

Ref	Description
1	Compressor
2	Condenser
3	Heating valve (NO) <sup>1</sup> - Option
4	Oil separator
5	Service point, high-pressure side
6	High-pressure switch
7	Liquid receiver & Filter dryer / Charge point
8	Defrost valve (NC) <sup>2</sup>
9	Sight glass
10	Pressure regulator (CRO) <sup>3</sup>
11	Service port, Low pressure
12	Thermostatic expansion valve (TXV)
13	Evaporator
14	Service port, Low pressure <sup>4</sup>
A	Liquid line
B	Evaporator outlet
E	Defrost line
CD	Compressor discharge = oil separator inlet
CS	Compressor suction

1. NO = Normally open
2. NC = Normally closed
3. CRO = Close on rise of outlet pressure
4. Only on Frigo Top 24 with R452A

# 7 Install the compressor

## 7.1 Fill the compressor with oil

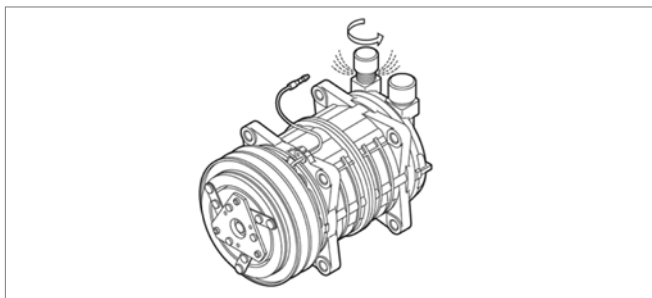

Fig. 32: Nitrogen can escape

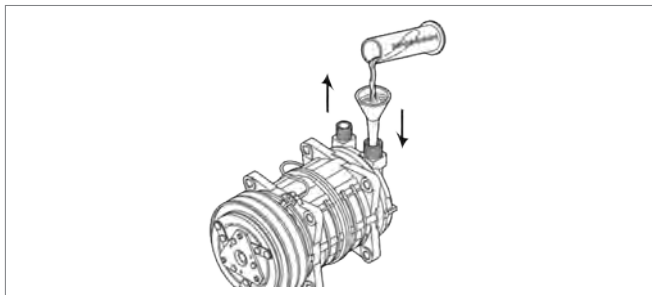

Fig. 33: Fill the compressor with oil

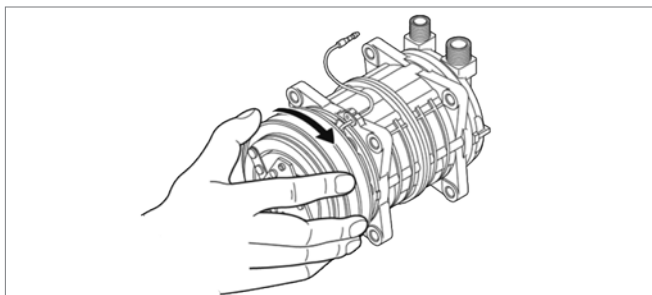

Fig. 34: Distribute the oil in the cylinders

Make sure that the compressor is filled with oil.



Compressor specific information can be found in the documents supplied with the compressor.

▶ Remove the plugs from the compressor.



New compressors are often filled with nitrogen. When you remove the plugs nitrogen can escape.



Make sure to use the right oil.

- See Tbl. 18 for oil type.
- Oil specified by the compressor's manufacturer must be the same as delivered by Webasto

▶ Fill the compressor through the suction port with oil according to the specifications of the compressor's manufacturer.

▶ Turn the compressor pulley 5 times to distribute the oil in the cylinders.

▶ Mount the compressor according to the supplier instructions.



If the compressor is not directly mounted then close the compressor with the plugs.

Refrigerant	Oil type
R134a	PAG
R404A	POE68
R452A	POE68

Tbl. 18: Oil type

### Information on safe use

- Oil must be free of dust and metal parts.
- Do not mix oils.
- Close the oil can directly after use. The oil easily absorbs humidity. The humidity of the oil should never exceed 1,000 ppm.



## 8 Crimp the hose to the fitting

This chapter describes the general procedure how to assemble the fitting to a hose.

### 8.1 Cut hose and lubricate the O-rings

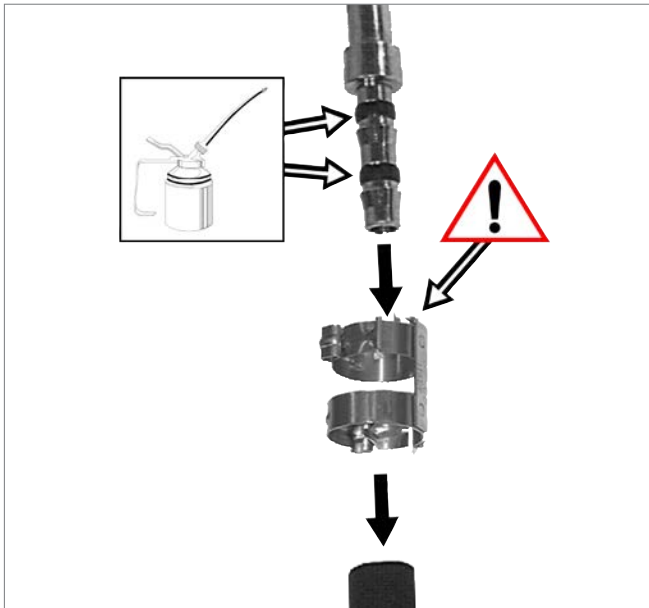

Fig. 35: Place clamp, lubricate fitting



#### ATTENTION

Incorrectly cut hose

Result: Leakage

- ▶ Make sure that the hose is cut in perpendicular direction

- ▶ Check the dimensions of fitting and hose.
- ▶ Place the clamp on the hose.
- ▶ Lubricate the O-ring of the fitting. (Use the same oil as used in the refrigeration system).

### 8.2 Insert the fitting



Fig. 36: Check clamp and fitting

- ▶ Check that the tab of the clamp is aligned with the end of the hose.
- ▶ Insert the fitting in the hose.
- ▶ Position the fitting.

### 8.3 Tighten the clamp

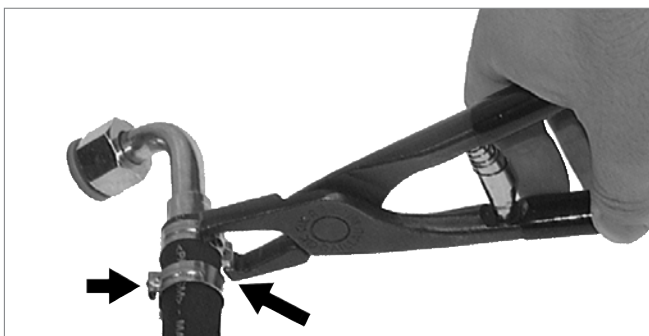

Fig. 37: Tighten the clamp

- ✓ Fitting and clamp are positioned correctly.
- ▶ Lock the clamp at 2 positions using the right pliers.



## 9 Hose lay-out in Frigo Top

The images below shows the hose lay-out in the Frigo Top.

### 9.1 Frigo Top 24 RT-D

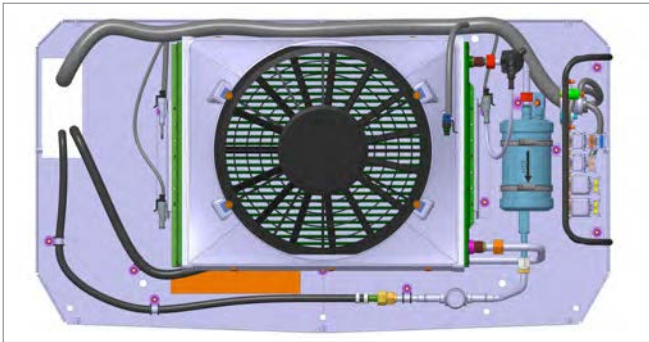

Fig. 38: Frigo Top 24 RT-D, hose lay-out condenser R134a

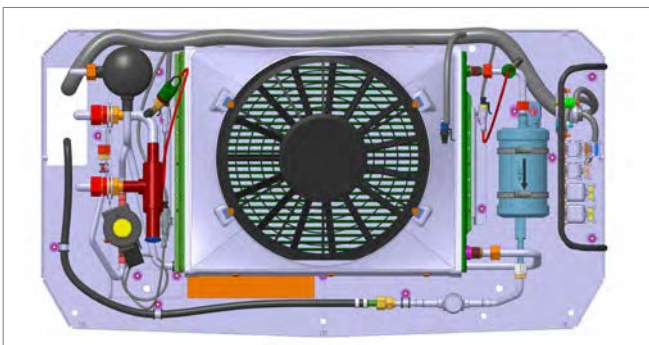

Fig. 39: Frigo Top 24 RT-D, hose lay-out condenser R452A

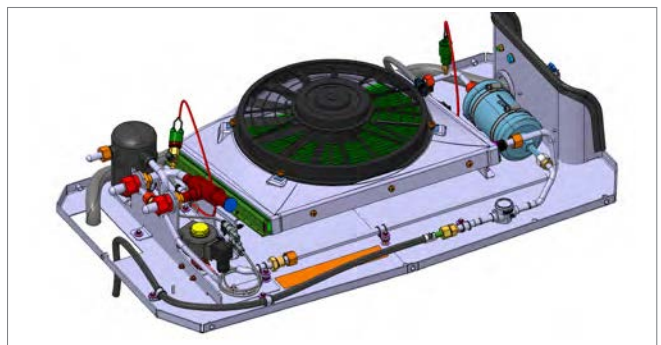

Fig. 40: Frigo Top 24 RT-D, hose lay-out condenser R452A

### 9.2 Frigo Top 36 RT-D

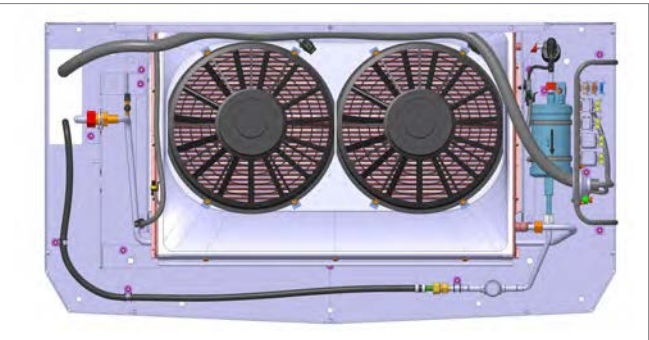

Fig. 41: Frigo Top 36 RT-D hose lay-out condenser R134a

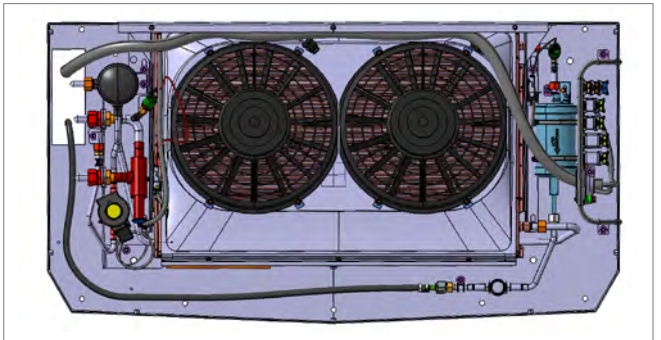

Fig. 42: Frigo Top 36 RT-D hose lay-out condenser R452A

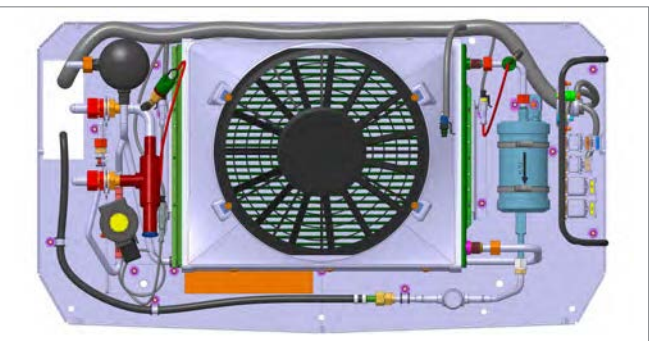

Fig. 43: Frigo Top 36 RT-D hose lay-out condenser R404A

### 9.3 Frigo Top 38 RT-D

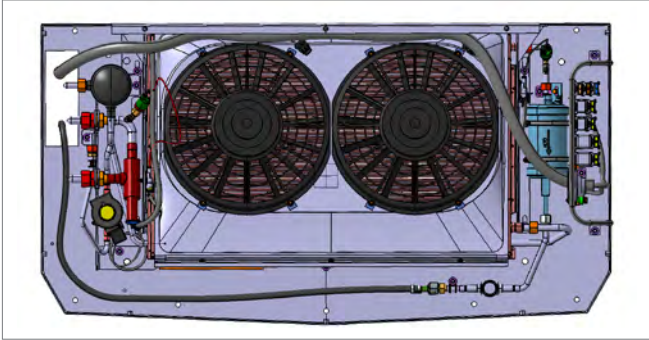

Fig. 44: Frigo Top 38 RT-D hose lay-out condenser R404A

### 9.4 Frigo Top 43 RT-D

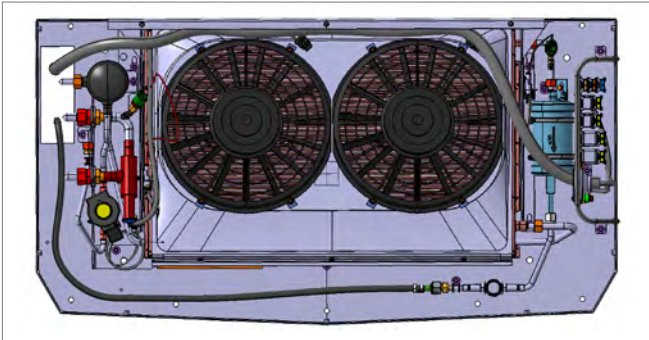

Fig. 45: Frigo Top 43 RT-D hose lay-out condenser R404A and R452A

# 10 Install control element

## 10.1 Install control element in the dashboard

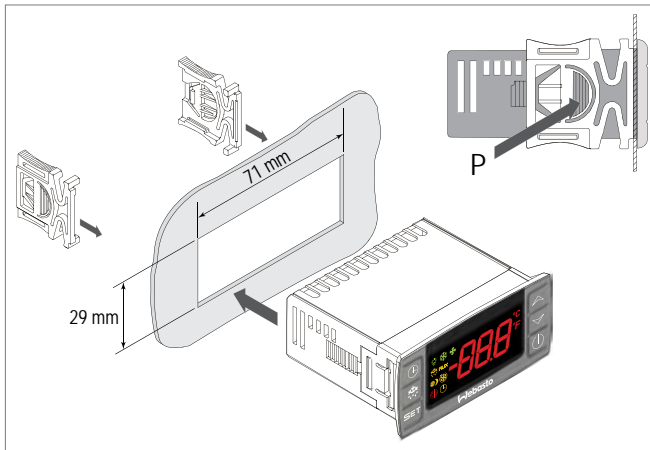

Fig. 46: Panel cut out

Find the right place in the drivers cabin where the display will fit.



### ATTENTION

Incorrectly chosen location for cut-out

Result: Damage of wiring and or components behind the panel.

► Check space behind panel before making the cut-out.

✓ Location for control panel has been checked.

► Make a cut out of 71 mm wide and 29 mm high.

P = press to release the brackets

## 10.2 Install control element in a box

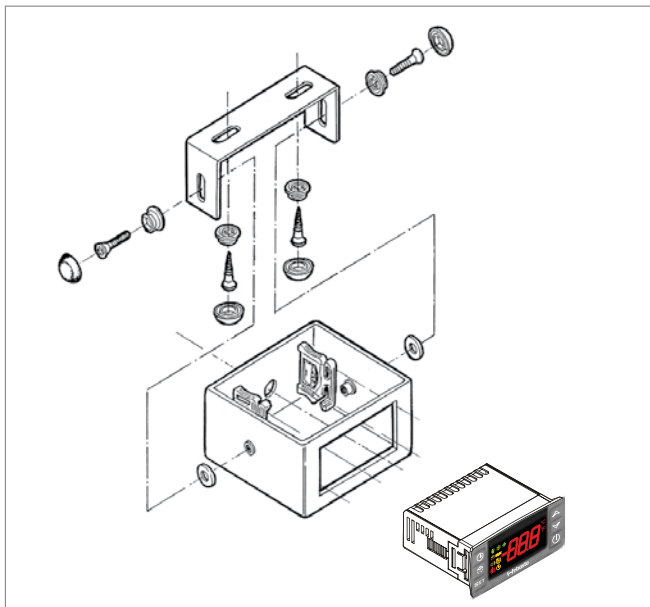

Fig. 47: Housing for control element

If there is no place to make a cut out then use the supplied housing for the control element.

► Mount the housing as shown in Fig. 47

## 10.3 Connect the control element

System	Refrigerant	See wiring diagram on page
Frigo Top 24 RT-D	R134a	34
	R452A	34
Frigo Top 36 RT-D	R134a	38
	R404A	36
	R452A	38
Frigo Top 38 RT-D	R404A	38
Frigo Top 43 RT-D	R404A	38
	R452A	38

Tbl. 19: Wiring diagram on page

► Feed the wiring through the vehicle

► Connect the wires to the control element

The cable connections are shown in the wiring diagrams.

Tbl. 19 shows the wiring diagram page number.

# 11 Vacuum and charge the system

## 11.1 General procedure

- ✓ The refrigeration system is fully installed.
- ✓ Hoses are checked on correct and tight connections.
- ✓ Refrigerant type has been checked with system nameplate
- ✓ Correct oil type for refrigerant has been checked
- ▶ Connect gauge set to refrigeration system
- ▶ Check system on leakage with nitrogen
- ▶ Vacuum down the refrigeration system
- ▶ Charge system with refrigerant
- ▶ Check system on leakage
- ▶ Adjust pressure regulator (CRO) (for systems with R452A and R404A only)

## 11.2 Vacuum down the system

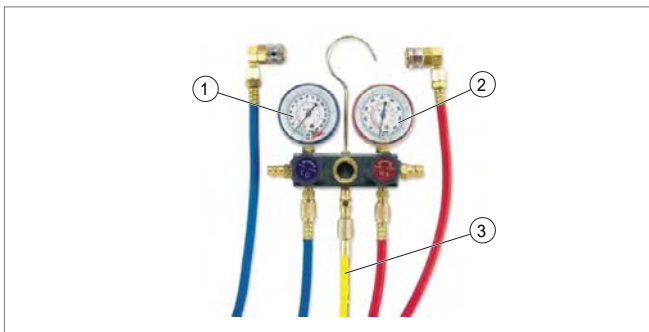

Fig. 48: Gauge set

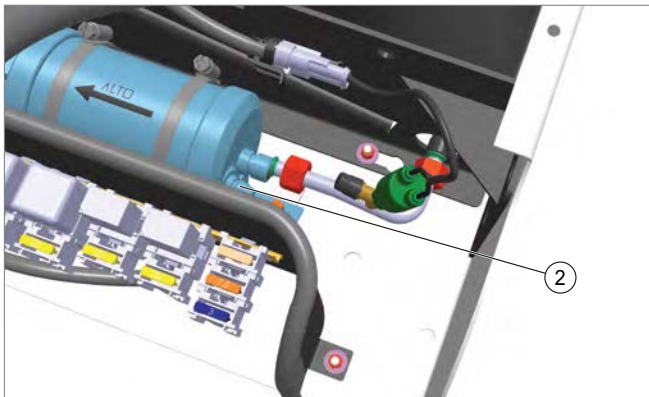

Fig. 49: Frigo Top Charge point, high pressure side

### Prepare gauge set

Fig. 48 shows a common gauge set for vacuum and charging the system. (Gauges can differ from the one shown here)

1. Low pressure side (Blue)
2. High pressure side (Red)
3. Vacuum hose / refrigerant supply (Yellow)

- ▶ Close all gauge valves before connecting the hoses to the A/C system.

### Connect gauge to the refrigeration system



A new condenser is filled with nitrogen. The nitrogen must be removed before charging the system with refrigerant.

- ✓ The instruction below is only valid for new systems not already charged with refrigerant.
- ▶ Connect the low pressure gauge (Blue) to the low pressure service port located in the condenser unit. See Fig. 29 / Fig. 30 or Fig. 31
- ▶ Connect the high pressure gauge (Red) to the high pressure charge port located on the Liquid receiver / Filter dryer in the condenser unit.
- ▶ Connect the vacuum hose (yellow) to the vacuum pump.
- ▶ Vacuum down the system.



Make sure that the vacuum reaches 60 Pa.  
■ The sight glass must be green.

- ▶ Close the gauge valves and switch of the vacuum pump.



After the vacuum pump is disconnected a pressure increase of maximum 30 Pa is allowed.

If the system is losing vacuum then there is a leakage.

Use a leak detector to check the system on leakage.

Turn on the system to increase the pressure and ease the detection of leaks.

### 11.3 Fill the service station with oil



Fig. 50: Fill service station with oil

- ✓ Keep the service station always lubricated according the instructions on the service station.
- ✓ Refrigerant type has been checked.
- ✓ Make sure that the oil type matches with the refrigerant type.



#### ATTENTION

Wrong refrigerant type  
Result: System damage.

- ▶ Check the refrigerant type mentioned on the name plate.

Refrigerant	Oil type	Quantity supplied [ml]
R134a	PAG	250
R404A	POE68	
R452A	POE68	

Tbl. 20: Oil type and quantity

### 11.4 Charge the system with oil and refrigerant (R134a)

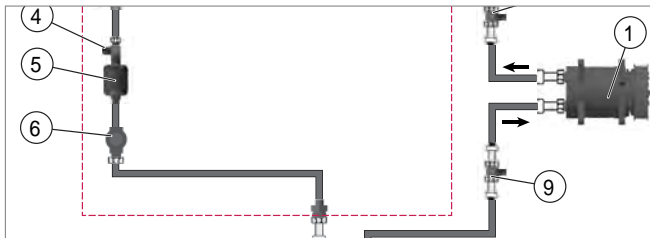

Fig. 51: R134a, low pressure service port, position 9

- ▶ Add 50 ml of oil in the system via the low pressure service port in the suction line.
- ▶ Charge system with refrigerant. For the amount of refrigerant see „Tbl. 22: Technical data“ on page 30
- ▶ Check system on leakage.

### 11.5 Charge the system with oil and refrigerant (R404A or R452A)

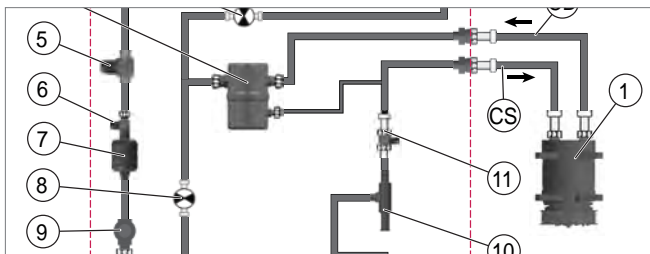

Fig. 52: R404A or R452A Condenser, low pressure service port, position 11

- ▶ Add 50 ml of oil in the system via the low pressure service port in the condenser.
- ▶ Charge system with refrigerant. For the amount of refrigerant see „Tbl. 22: Technical data“ on page 30
- ▶ Check system on leakage.



## 11.5.1 Adjust compressor intake valve (CRO)

CRO adjustment is only valid for systems with refrigerant R404A or R452A

The CRO valve prevent the compressor from overloading due to high suction pressure. The CRO valve limits the compressor intake pressure.

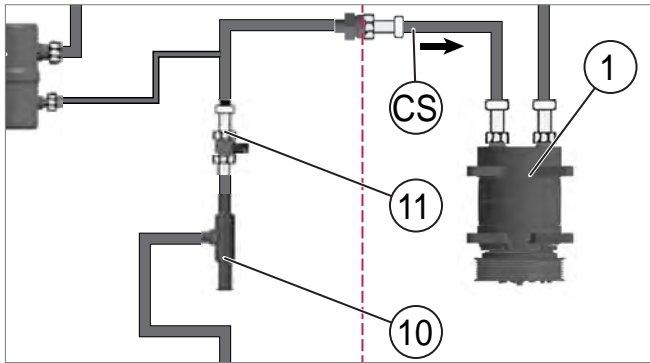

Fig. 53: CRO and Service port low pressure

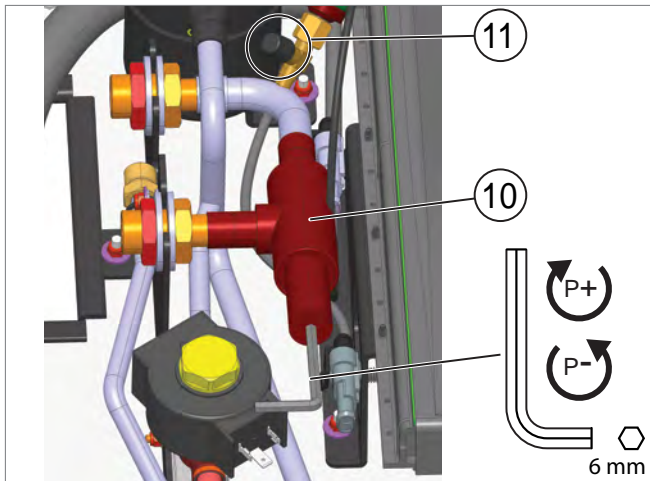

Fig. 54: Use an Allen key to adjust the pressure

The CRO is located in the condenser unit.



Adjust the CRO in one of the following operating modes:

- Heating
- Defrost
- First start in a hot cell ( $T \geq 25 \text{ }^\circ\text{C}$ )

- 1 Compressor
- 10 Pressure regulator (CRO)
- 11 Service point, Low pressure



### ATTENTION

Pressure in return line too high  
Result: System damage.

► **Max suction pressure 2,8 bar.**

- Connect a manometer to the Service point (11)
- Adjust the CRO (10) pressure setting with an Allen key (6 mm). See Tbl. 21 for pressure settings.
  - Turn clockwise to increase the pressure. Turn counter-clockwise to decrease the pressure.
  - Turn the Allen key half a turn and monitor the pressure change.
  - Wait for 30 seconds between 2 CRO adjustments

Refrigerant	Adjustment Pressure [bar (Relative)]
R404A	2,8
R452A	2,2

Tbl. 21: CRO pressure setting

## 12 Place the covers



### 12.1 Frigo Top 24 (R134a / R452A) / 36 (R404A) Condenser



Fig. 55: Place cover of the condenser Frigo Top 24 / 36

► Place front cover.

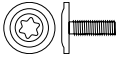
► Tighten bolts.

	INOX screw torx M6x20 (8x)	3 Nm
	Washer 7x19x2 (8x)	

### 12.2 Frigo Top 36 (R134a / R452A) / 38 (R404A) / 43 (R404A / R452A) Condenser

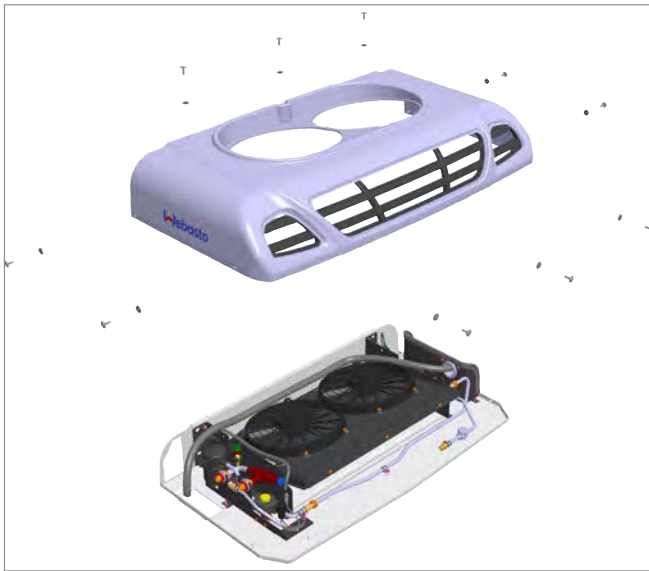
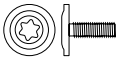



Fig. 56: Place cover of the condenser Frigo Top 36 / 38 / 43

► Place front cover.

► Tighten bolts.

	INOX screw torx M6x20 (10x)	3 Nm
	Washer 7x19x2 (10x)	

## 13 Initial operation

- General performance check.
- High and low pressure.
- Correct operation.



# 14 Technical data

Parameter	Frigo Top				
	24 RT-D	36 RT-D	36 RT-D	38 RT-D	43 RT-D
R134a [kg] *	1,15	--	1,35	--	--
R404A [kg] *	--	1,1	--	1,35	1,5
R452A [kg] *	1,15	--	1,45	--	1,45
Operating voltage [V]	12	12	12	12	12 / 24
Max. power consumption [A] - Engine operation	21,5	31	42	42	42 / 21
Air flow (Free blowing) [m³/h]	980	1740	1740	1740	1980
Dim. Condenser (LxWxH) [mm]	900x496x190	900x496x190	1115x663x194	1115x663x194	1115x663x194
Dim. Evaporator (LxWxH) [mm]	660x530x158	1000x500x157	1000x500x157	1000x500x157	1130x530x158
Weight Condenser [kg] R452A / R404A	15	15	31	31	31
Weight Condenser [kg] R134a	12	--	28	--	--
Weight Evaporator [kg]	10	12,5	12,5	12,5	18,5
A-weighted emission sound pressure level, LpA [dB] (UNI EN ISO 11204 June 2010)	72,1	72,1	74,3	74,3	74,3
<b>Capacity with refrigerant</b>	<b>R452A</b>		<b>R452A</b>		<b>R452A</b>
Cooling capacity [kW] (according ATP standard) at 30 °C ambient temperature and compartment temperature 0 °C (Engine operation)	2,4	--	3,7	--	4,2
Cooling capacity [kW] (according ATP standard) at 30 °C ambient temperature and compartment temperature -10 °C (Engine operation)	1,7	--	2,8	--	3,1
Cooling capacity [kW] (according ATP standard) at 30 °C ambient temperature and compartment temperature -20 °C (Engine operation)	1,1	--	1,5	--	2,1
<b>Capacity with refrigerant</b>	<b>R134a</b>		<b>R134a</b>		
Cooling capacity [kW] (according ATP standard) at 30 °C ambient temperature and compartment temperature +5 °C (Engine operation)	2,5	--	3,3	--	--
Cooling capacity [kW] (according ATP standard) at 30 °C ambient temperature and compartment temperature 0 °C (Engine operation)	2,1	--	2,8	--	--
Cooling capacity [kW] (according ATP standard) at 30 °C ambient temperature and compartment temperature -5 °C (Engine operation)	1,6	--	2,3	--	--
<b>Capacity with refrigerant</b>		<b>R404A</b>		<b>R404A</b>	<b>R404A</b>
Cooling capacity [kW] (according ATP standard) at 30 °C ambient temperature and compartment temperature 0 °C (Engine operation)	--	3,6	--	3,7	4,2
Cooling capacity [kW] (according ATP standard) at 30 °C ambient temperature and compartment temperature -10 °C (Engine operation)	--	2,6	--	2,8	3,1
Cooling capacity [kW] (according ATP standard) at 30 °C ambient temperature and compartment temperature -20 °C (Engine operation)	--	1,5	--	1,7	2,1

Tbl. 22: Technical data

\* The amount of refrigerant is based on 6 meter flexible hose between compressor and roof top system

# 15 Annex

## 15.1 Frigo Top cable assignment

Cable	Component	Cross section [mm <sup>2</sup> ]	Colour	Specification		
				24	36 (R404A)	36/38/43
002		0.5	red	x	x	x
003		0.5	blue	x	x	x
004		0.5	blue	x	x	x
021		0.5	blue	x	x	x
025		0.5	green	x	x	x
026		0.5	blu	x	x	x
100	EVC1	2.5	white	x	x	x
101	EVE1	2.5	white	x	x	x
102	YV1 - YV2	1.5	white	x	x	x
103	YC1	1.5	white			x
103	Clutch Comp.	1.5	white	x	x	
104	EVE2	2.5	white		x	x
105	EVC2	2.5	white			x
203		0.5	blue	x	x	x
226		0.5	blue	x	x	x
B+		10	red	x		
B+		16	red		x	x
B-		10	black	x		
B-		16	black		x	x
B+01		2,5	red	x		
B+01		4	red		x	x
B+02		2.5	red	x	x	x
B+03		2,5	red	x		
B+03		6	red		x	x
B+04		2.5	red	x	x	x
B+05		1.5	red	x	x	x
B+06		1.5	red	x	x	x
B+07		1.5	red	x	x	x
B+08		1.5	red	x	x	x
B+09		2.5	red		x	x
B+10		2.5	red			x
B-01	EVC1	2.5	black	x	x	x
B-02	EVE1	2.5	black	x	x	x
B-03	YV1 - YV2	1.5	black	x	x	x
B-05		0.5	black	x	x	x
B-06		0.5	black	x	x	x
B-07		0.5	black	x	x	x
B-08		0.5	black	x	x	x
B-10	EVE2	2.5	black		x	x
B-11	EVC2	2.5	black			x

Tbl. 23: Cable assignment

## 15.2 Frigo Top components

Abbreviation	Description	Specification	
		12 V	24 V
GB1	Battery		
B+	Clamp 30		
B-	Clamp 31		
+15	Clamp 15		
EVC1 - EVC2	Axial fan condenser		
EVE1 - EVE2	Axial fan evaporator		
YV1 - YV2	Defrost Valve/ Heating Valve		
YC1	Clutch Compressor	4A	20A
RL11	Relay axial fan condenser	70A	40A
RL12	Relay axial fan evaporator	70A	40A
RL13	Relay Valve	15/25A	10/15A
RL14	Relay Compressor	15/25A	10/15A
K11	Coil relay RL11		
K12	Coil relay RL12		
K13	Coil relay RL13		
K14	Coil relay RL14		
F100	Main fuse	80A	50A
F101	Fuse axial fan condenser	20A	15A
F102	Fuse axial fan evaporator	20A	10A
F103	Fuse valve	5A	5A
F104	Fuse compressor	7,5A	5A
F105	Fuse electronic part	3A	3A
F106	Fuse axial fan evaporator	20A	10A
F107	Fuse axial fan condenser	20A	15A
F108	Fuse clamp 15	3A	3A
H1	Control panel		
BP1	High pressure switch		
BP2	Low pressure switch		
BP3	Pressure switch trinary		
BT1	Room temperature sensor		
BT2	Defrost temperature sensor		



Tbl. 24: Components Frigo Top

## 15.3 Cable colours

Abbreviation	Colour
WHT / White	White
BLU / Blue	Blue
YEL / Yellow	Yellow
GRY / Grey	Grey
BN / Brown	Brown
BLK / Black	Black
PNK / Pink	Pink
RED / Red	Red
GRN / Green	Green
VT / Violet	Violet

Tbl. 25: Cable colours

## 15.4 Symbols

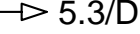
Symbol	Description
	Female connector
	Male connector
	<p>Wire continues in other wiring diagram. Code refers to sheet and coordinates</p> <p>Example 5.3/D:</p> <ul style="list-style-type: none"> <li>■ 5 refers to sheet number shown in right lower corner</li> <li>■ 3 refers to column number</li> <li>■ D refers to row</li> </ul>

Tbl. 26: Cable symbols

## 15.5 Wiring diagram overview

System	Refrigerant	Page number	
		Power circuit	Auxiliary
Frigo Top 24 RT-D	R134a	33	34
	R452A	33	34
Frigo Top 36 RT-D	R134a	37	38
	R404A	35	36
	R452A	37	38
Frigo Top 38 RT-D	R404A	37	38
Frigo Top 43 RT-D	R404A	37	38
	R452A	37	38

Tbl. 27: Wiring diagram overview

## 15.6 Diagram Frigo Top 24 RT-D, 12 V, power circuit, (R134a, R452A)

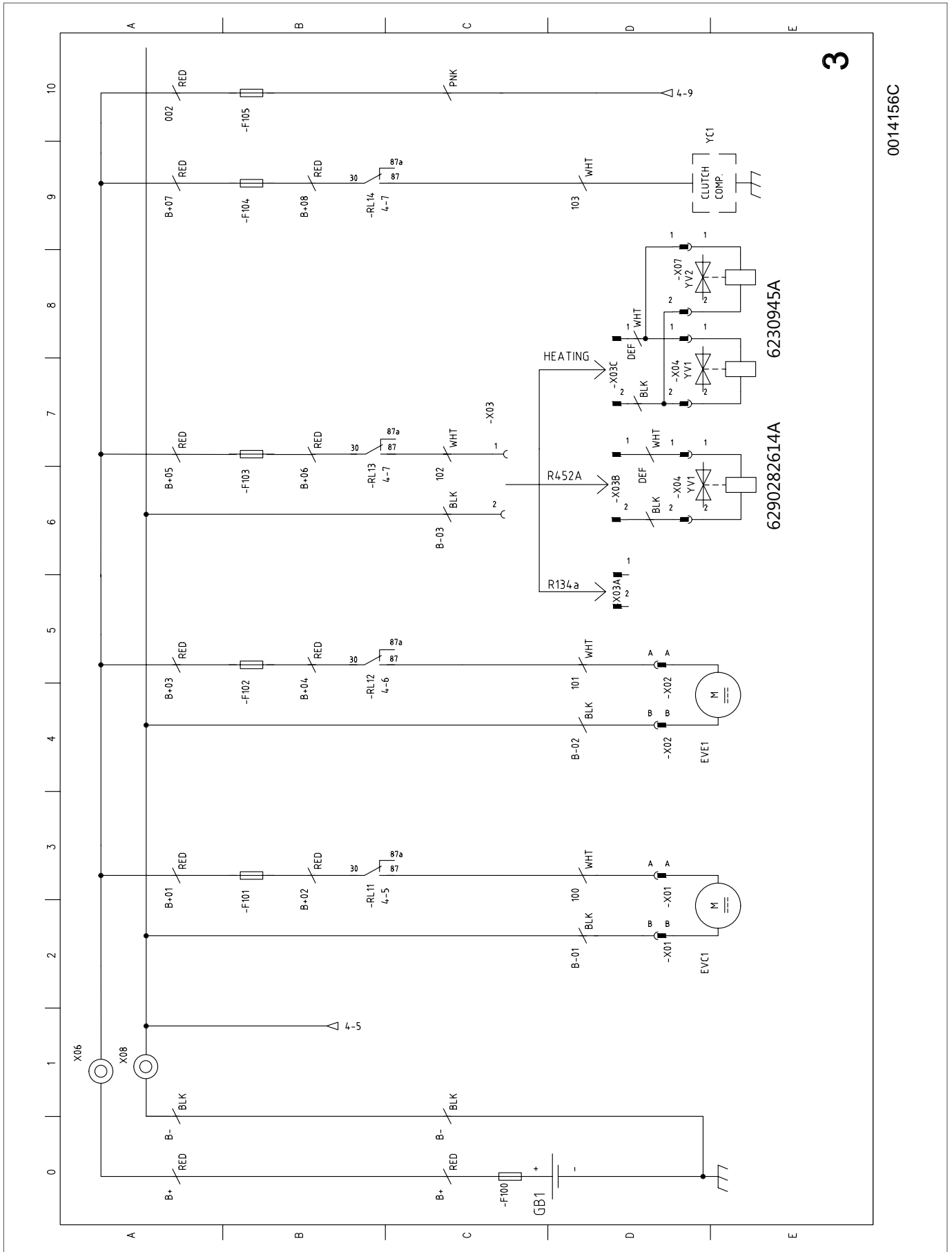
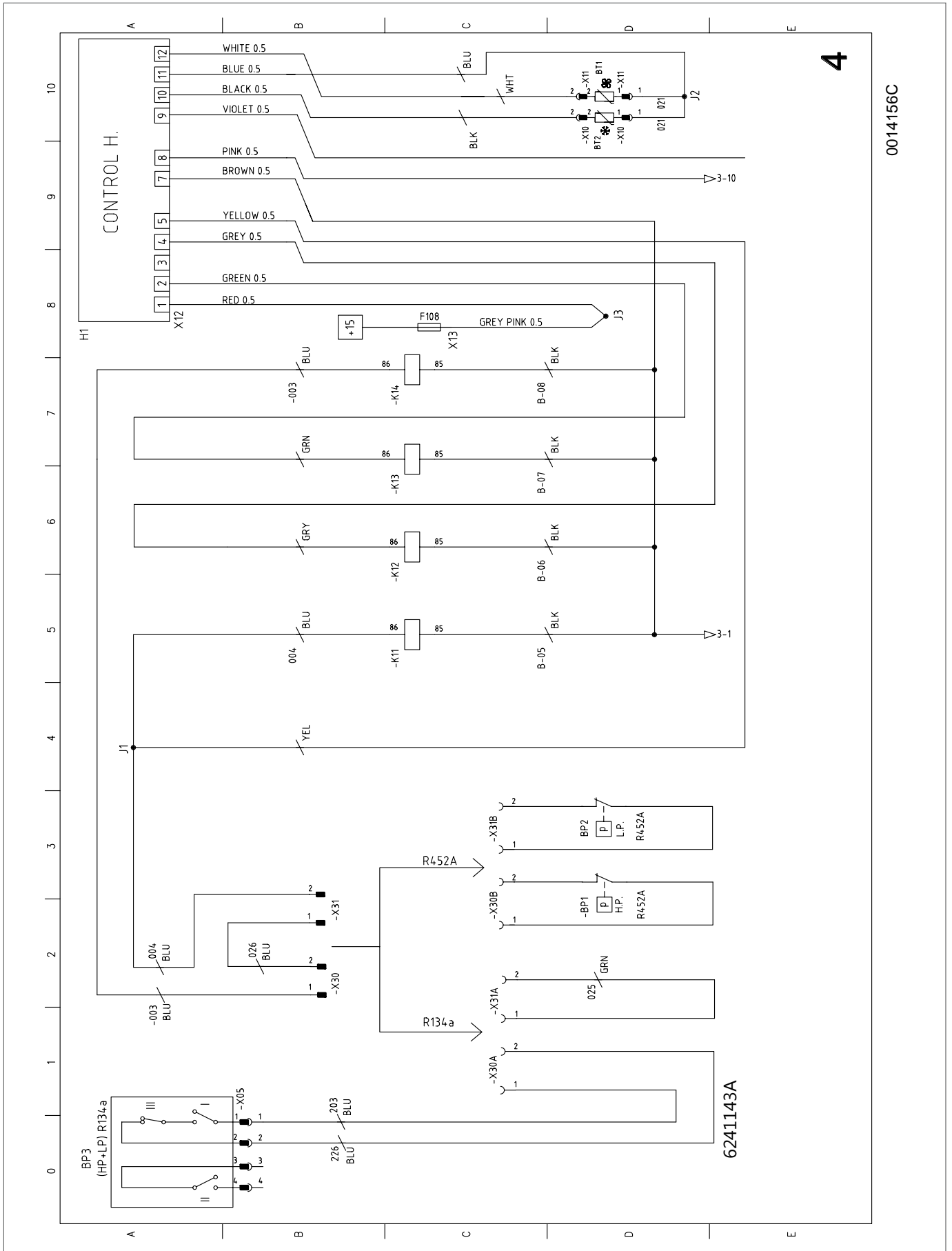

Fig. 57: Wiring diagram Frigo Top 24 RT-D, 12 V, power circuit, (R134a, R452A)

### 15.7 Diagram Frigo Top 24 RT-D, 12 V, auxiliary, (R134a, R452A)



0014156C

4

Fig. 58: Wiring diagram Frigo Top 24 RT-D, 12 V, auxiliary, (R134a, R452A)

## 15.8 Diagram Frigo Top 36 RT-D, 12 V, power circuit, (R404A)

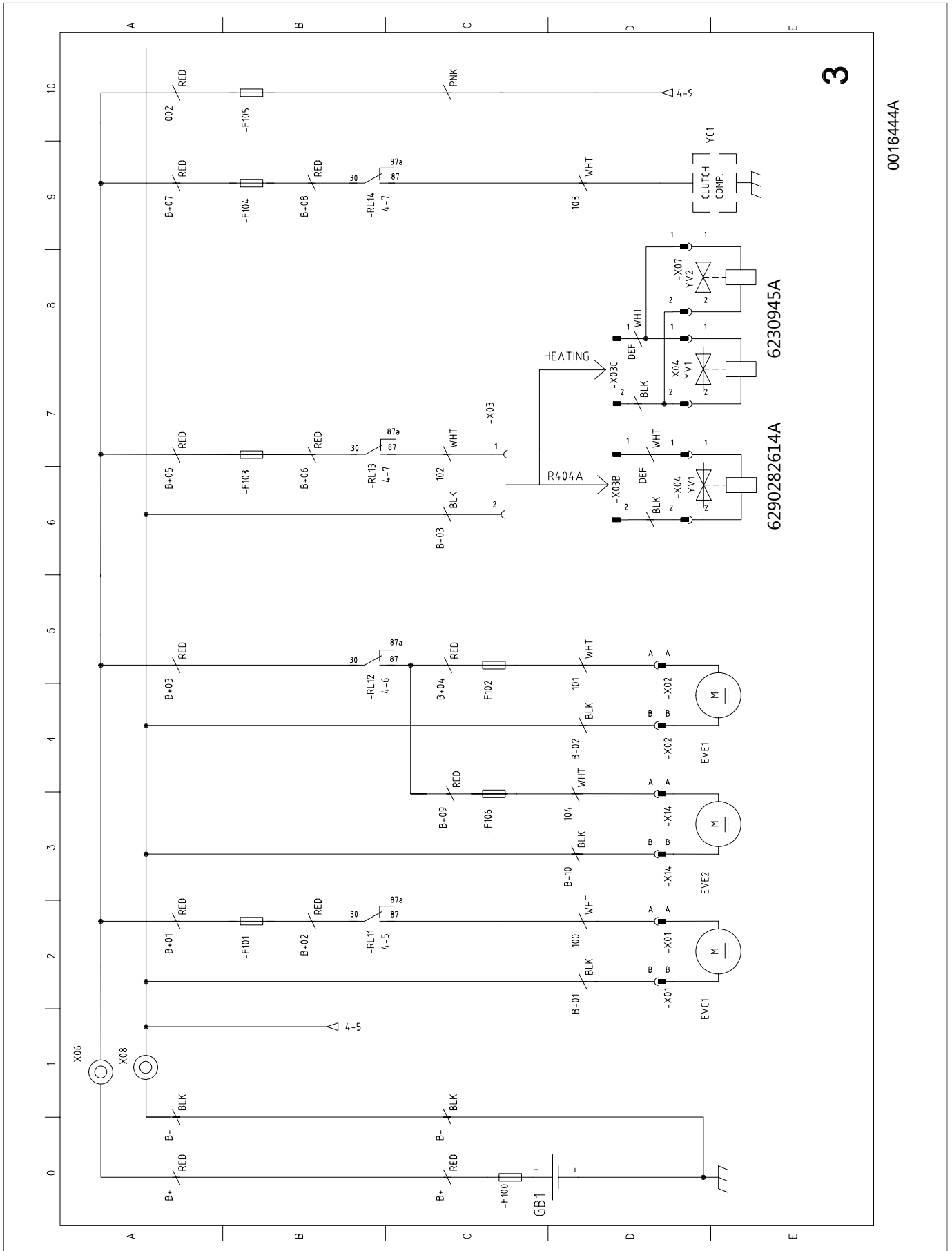

0016444A

Fig. 59: Wiring diagram Frigo Top 36 RT-D, 12 V, power circuit, (R404A)

### 15.9 Diagram Frigo Top 36 RT-D, 12 V, auxiliary, (R404A)

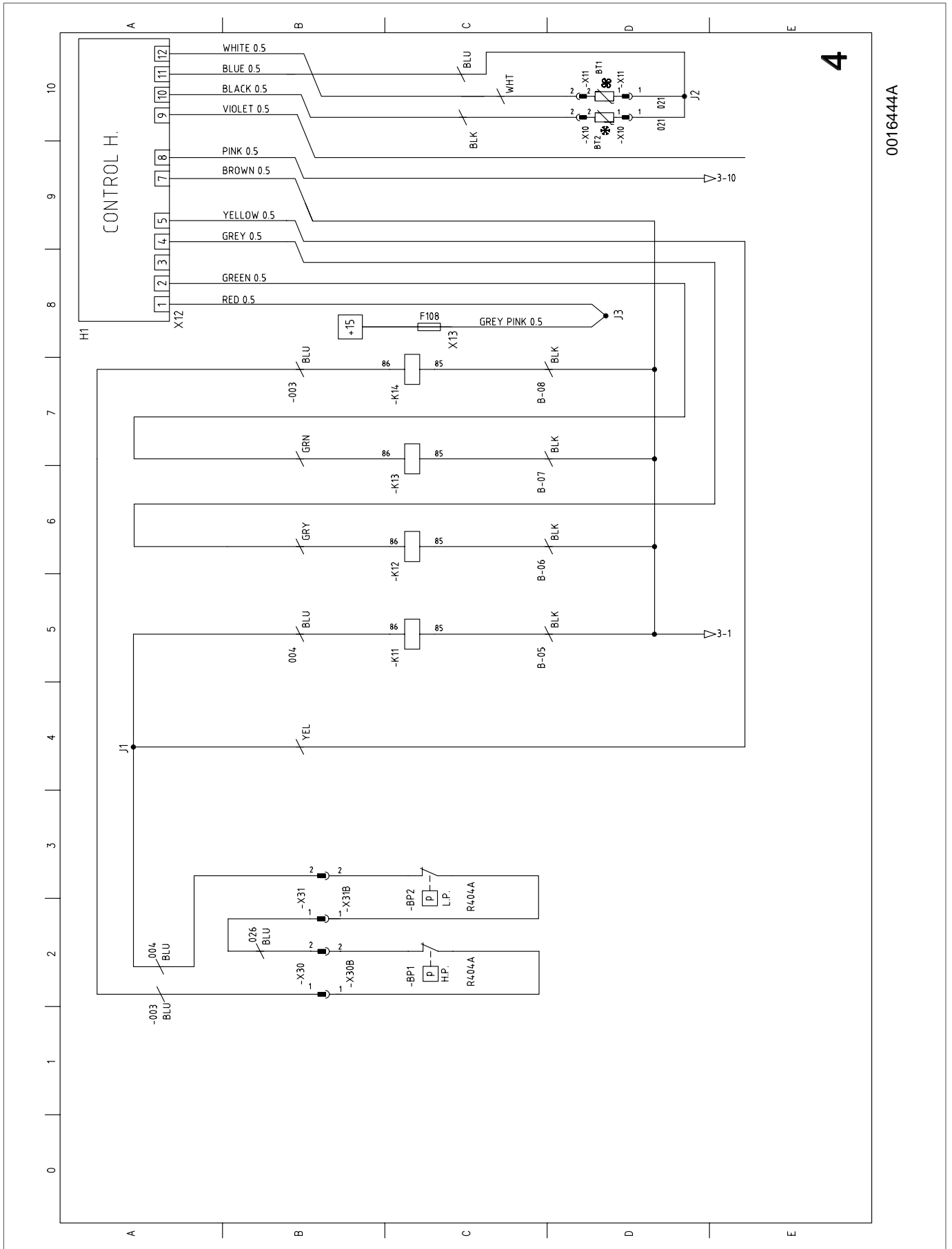

0016444A

4

Fig. 60: Wiring diagram Frigo Top 36 RT-D, 12 V, Auxiliary, (R404A)



15.10 Diagram Frigo Top 36 RT-D, 12 V, (R134a, R452A)  
 38 RT-D, 12 V, (R404A)  
 43 RT-D, 12-24 V, (R404A, R452A), power circuit

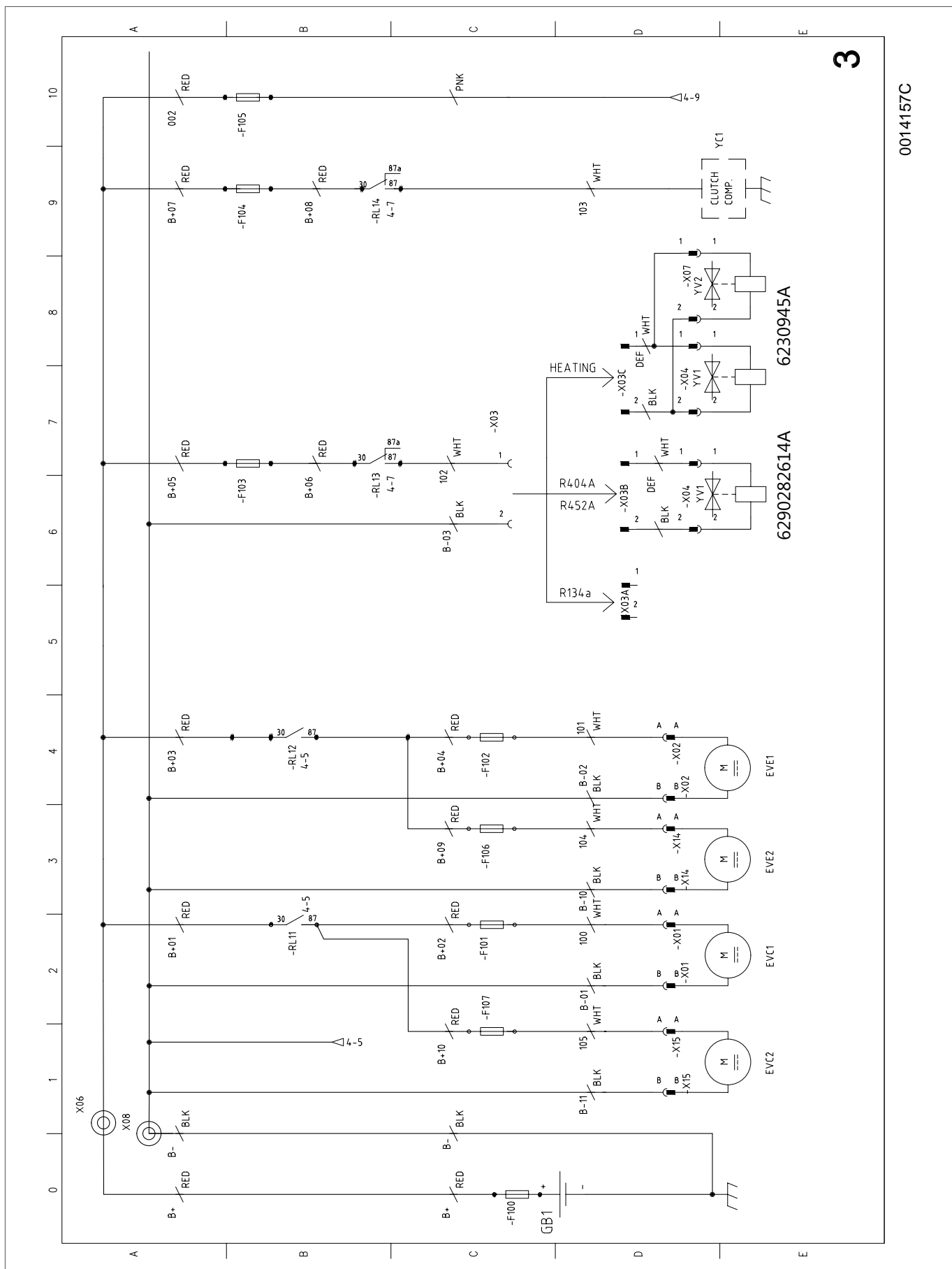

0014157C

Fig. 61: Wiring diagram Frigo Top 36 RT-D, 12 V, (R134a, R452A) / 38 RT-D, 12 V, (R404A) / 43 RT-D, 12-24 V, (R404A, R452A), power circuit

15.11 Diagram Frigo Top 36 RT-D, 12 V, (R134a, R452A)  
 38 RT-D, 12 V, (R404A)  
 43 RT-D, 12-24 V, (R404A, R452A), auxiliary

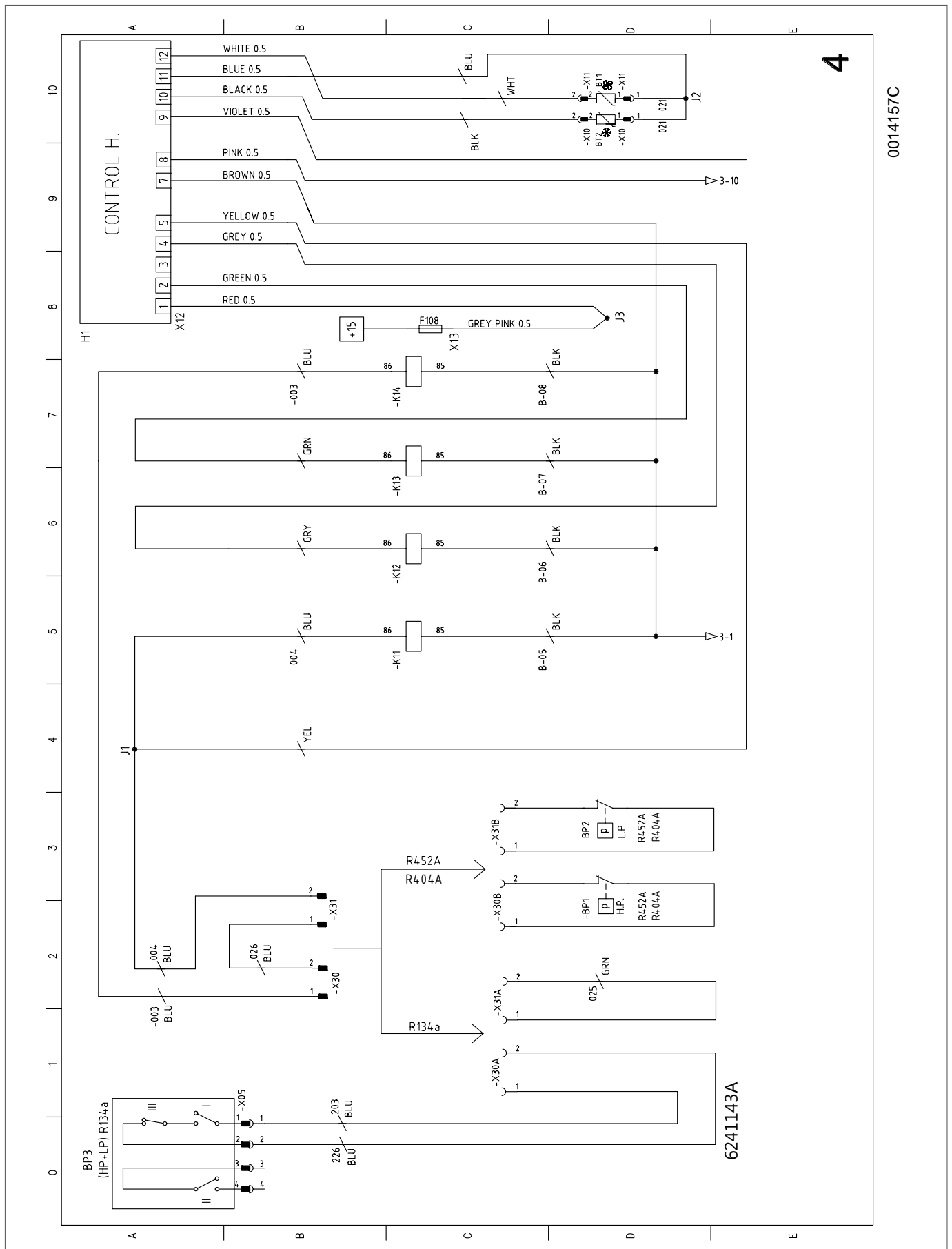

Fig. 62: Wiring Diagram Frigo Top 36 RT-D, 12 V, (R134a, R452A) / 38 RT-D, 12 V, (R404A) / 43 RT-D, 12-24 V, (R404A, R452A), auxiliary



In multilingual versions the English language is binding.

The telephone number of the respective country can be obtained from the Webasto service point flyer or the homepage of your respective Webasto country representative.

Webasto Thermo & Comfort SE  
Postfach 1410  
82199 Gilching  
Germany

Visiting address:

Friedrichshafener Str. 9  
82205 Gilching  
Germany

Technical Extranet: <http://dealers.webasto.com>

[www.webasto.com](http://www.webasto.com)

