

Montageanleitung

344 200 LED Mehrfunktionsleuchte

Mounting instructions

344 200 LED Multifunction lamp

Instructions de montage

344 200 LED Feu multifonctions

Monteringsanvisning

344 200 LED Multilampa

Montagehandleiding

344 200 LED Multifunctionele lamp

Instrucciones de montaje

344 200 LED Lámpara multifunción

Istruzioni di montaggio

344 200 LED Fanale multifunzione

Asennusohje

344 200 LED Monitoiminto lamppu



Lieferumfang
Kit includes
Fourniture

Leveransomfattning
Inhould set
Volumen del suministro

Dotazione di fornitura
Osaluettelo

2

1 x

2SD 344 200-00 (SBBL)
2SD 344 200-02 (SB)
2SD 344 200-03 (BL)



3

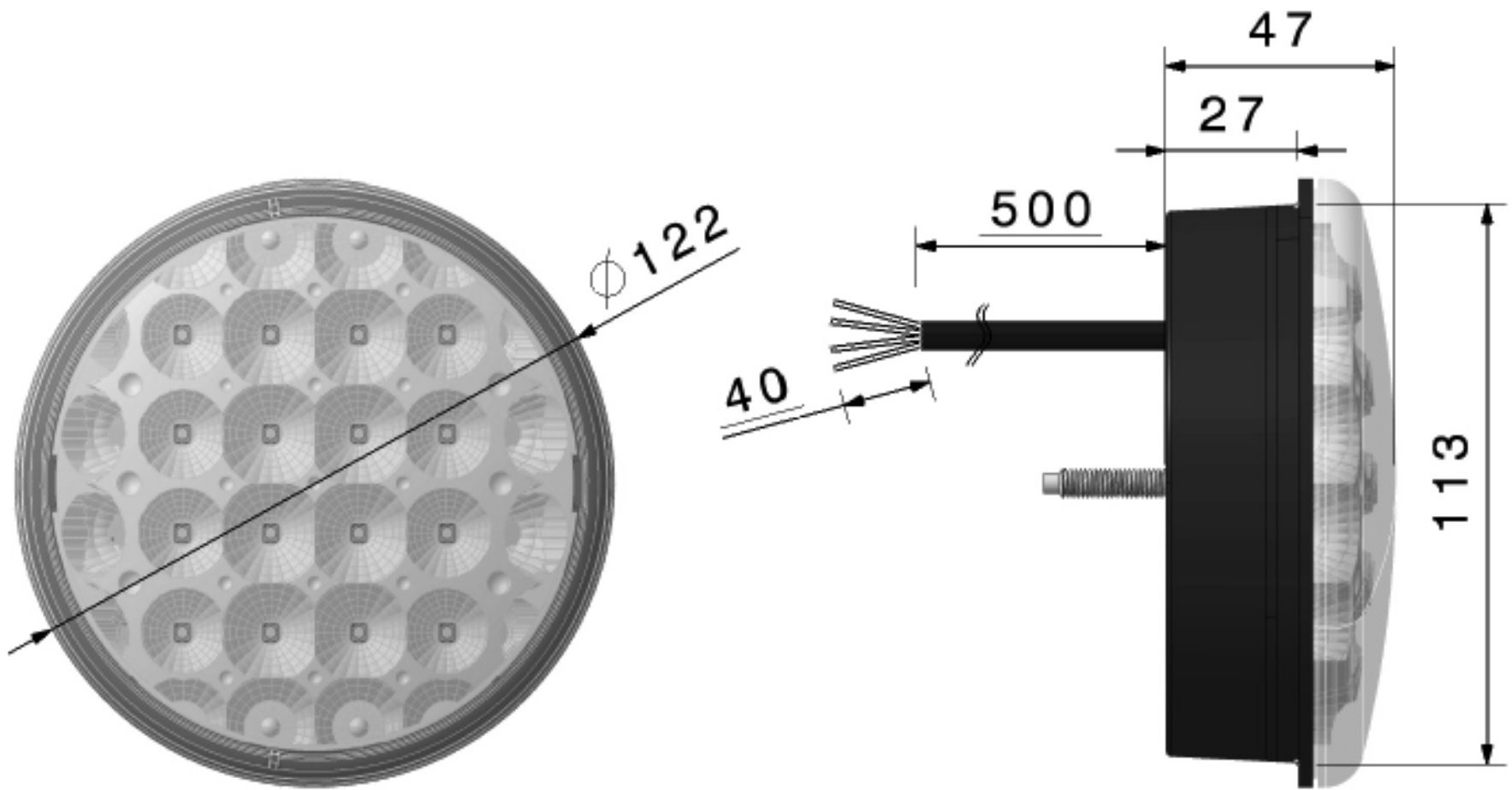

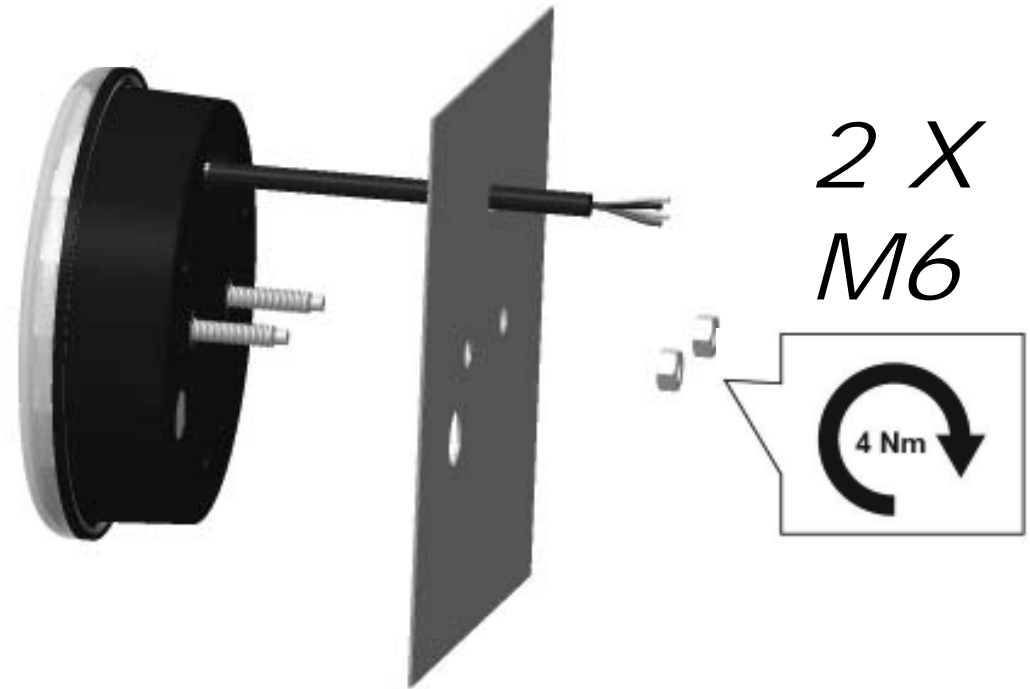
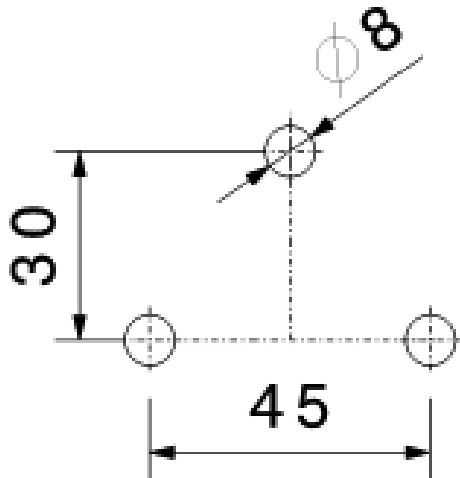
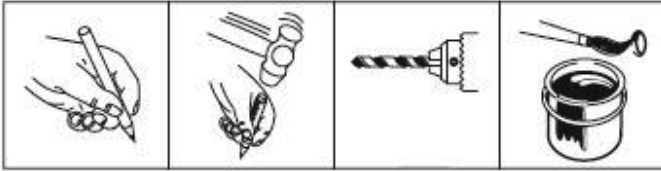

2 X
M6



Nicht im Lieferumfang enthalten
Not included with kit
Non fournis
Ingår ej i leveransen
Worden niet meegeleverd
No se incluyen en el suministro
Non in dotazione
Eivät kuulu toimitukseen



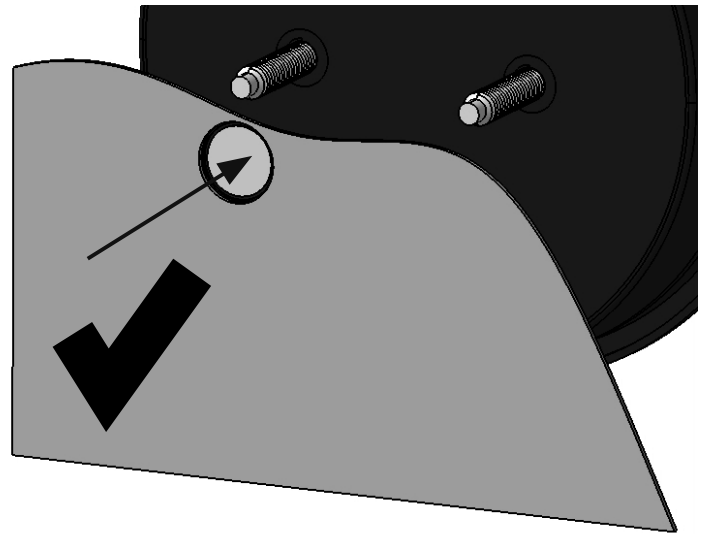
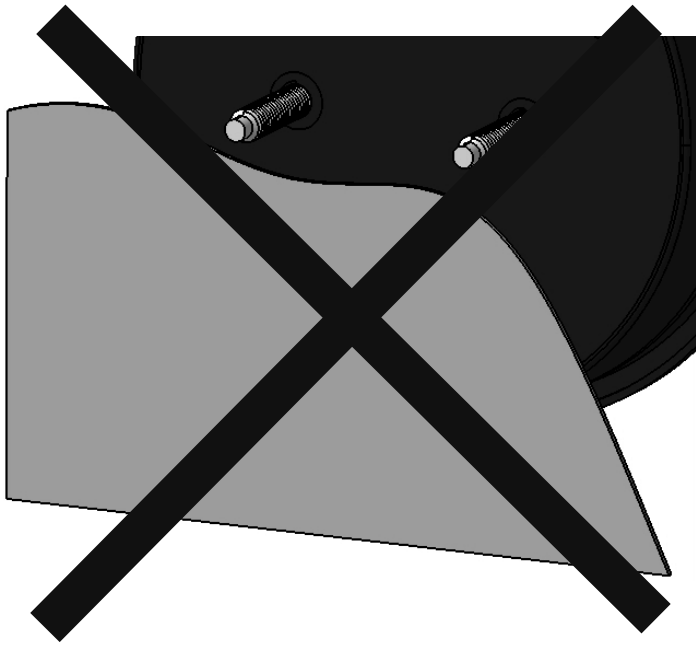
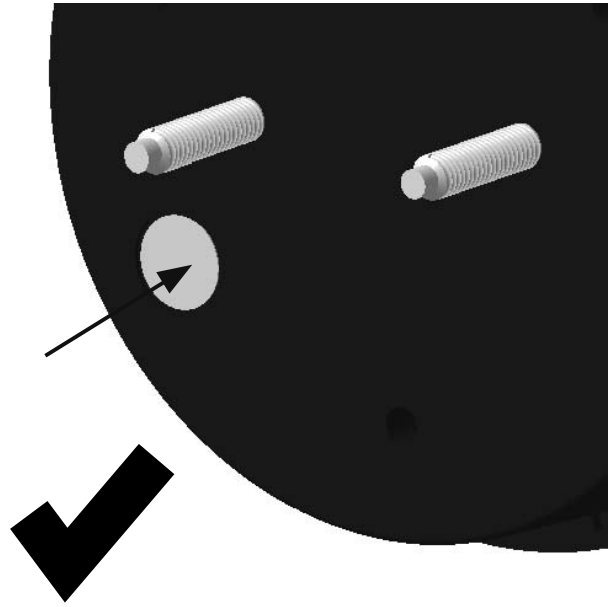

D

- 1. Gelb = + Blinklicht
- 2. Weiss = - Masse
- 3. Rot = + Bremslicht
- 4. Schwarz = + Schlusslicht

NL

- 1. Geel = + Richtingaanwijzerlicht
- 2. Wit = - Massa
- 3. Rood = + Remlicht
- 4. Zwart = + Achterlicht

GB

- 1. Yellow = + Turn indicator
- 2. White = - Ground
- 3. Red = + Stop light
- 4. Black = + Tail light

ES

- 1. Amarillo = + Luz del indicador de direccion
- 2. Blanco = - Masa
- 3. Rojo = + Luz de paro
- 4. Negro = + Luz trasera

FR

- 1. Jaune = + Feu clignotant
- 2. Blanc = - Masse
- 3. Rouge = + Feu stop
- 4. Noir = + Feu arriere

IT

- 1. Giallo = + Direzioneeluze indicatore
- 2. Bianco = - Terra
- 3. Rosso = + Luce stop
- 4. Nero = + Luce di coda

SV

- 1. Gul = + Blinkerljus
- 2. Vit = - Jord
- 3. Röd = + Bromsljus
- 4. Svart = + Bakljus

FIN

- 1. Keltainen = + Vilkku
- 2. Valkoinen = - Maa
- 3. Punainen = + Jarruvalo
- 4. Musta = + Takavallo

<i>Technische Daten</i>		344 200 LED Mehrfunktionsleuchte
Art.-Nr.	2SD-	344 200-00/-02/-03
Eingangsspannung Stromverbrauch		9 - 32V 1 - 2 W
Materialien		Gehäuse: PC/ABS, Lichtscheibe: PMMA, Reflektor: PC
IP Klasse		6K9K

<i>Technical data</i>		344 200 LED Multifunction lamp
Part No	2SD-	344 200-00/-02/-03
Input voltage Power consumption		9 - 32V 1 - 2 W
Materials		Housing: PC/ABS, Lens: PMMA, Reflector: PC
IP Class		6K9K

<i>Données techniques</i>		344 200 LED Feu multifonctions
Référence	2SD-	344 200-00/-02/-03
Tension d'entrée Consommation		9 - 32V 1 - 2 W
Matériaux		Boîtier: PC/ABS, Voyant: PMMA, réflecteur: PC
Classe IP		6K9K

Teknisk information

344 200 LED Multilampa

Artikelnr	2SD-	344 200-00/-02/-03
Inspänning Effektförbrukning		9 - 32V 1 - 2 W
Material		Kåpa: PC/ABS, Lins: PMMA, Reflektor: PC
IP klass		6K9K

Technische gegevens

344 200 LED Multifunctionele lamp

Artikelnr.	2SD-	344 200-00/-02/-03
Ingångsspänning Opgenomen ver- mogen		9 - 32V 1 - 2 W
Materialien		Huis: PC/ABS, Lens: PMMA, Reflector: PC
IP Klasse		6K9K

Datos técnicos

344 200 LED Lámpara multifunción

Nºde artículo	2SD-	344 200-00/-02/-03
Tensión de entrada Consumo de cor- riente		9 - 32V 1 - 2 W
Materiales		Caja: PC/ABS, Lente: PMMA, Reflector: PC
Clase IP		6K9K

Dati tecnici

344 200 LED Fanale multifunzione

N. art.	2SD-	344 200-00/-02/-03
Tensione di ingresso Assorbimento di potenza		9 - 32V 1 - 2 W
Materiali		Scatola: PC/ABS, Lente: PMMA, Riflettore: PC
Classe IP		6K9K

Tekniset tiedot

344 200 LED Monitoiminto lamppu

Tuotenro.	2SD-	344 200-00/-02/-03
Jännite Teho		9 - 32V 1 - 2 W
Materiaalit		Runko: PC/ABS, Lasi: PMMA, Heijastaja: PC
IP Luokka		6K9K

9