

Kit 1360

SKODA Octavia (M.k.II), 4-dr Sedan, 04-09

SKODA Octavia (M.k.II), 5-dr Hatchback, 04-09

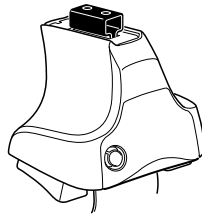

754 Rapid System
480R Rapid Traverse (North America)

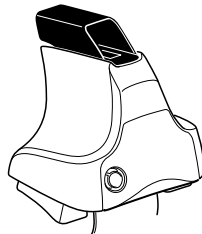
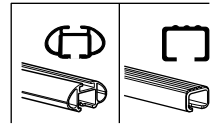

480 Traverse (North America)

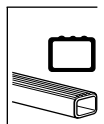

754 Rapid System
480R Rapid Traverse (North America)

754 Rapid System
480R Rapid Traverse (North America)

480 Traverse (North America)

(North America)

661 x1 **668 x1**
662 x1 **673 x1**
179 x2
181 x2
x1

1

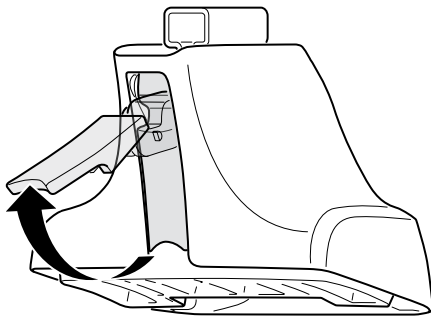

2



754 Rapid System
480R Rapid Traverse
(North America)

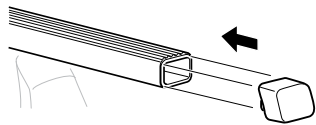
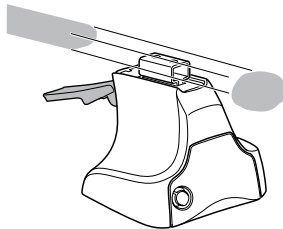

x4

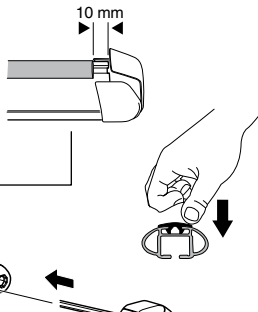
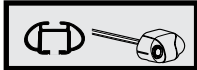

x4

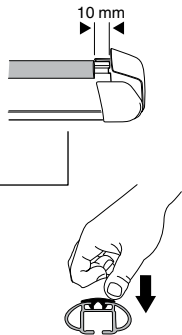

x4



480 Traverse
(North America)

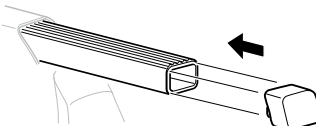
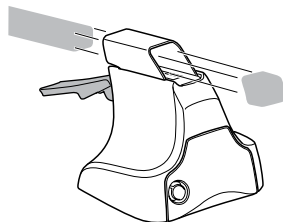

x4

3

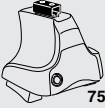

754 Rapid System

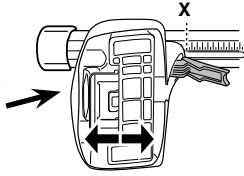

	X
SKODA Octavia (M.k.II), 4-dr Sedan, 04-09	33
SKODA Octavia (M.k.II), 5-dr Hatchback, 04-09	33

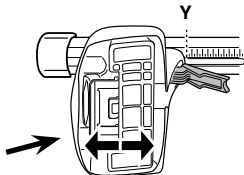

	Y
SKODA Octavia (M.k.II), 4-dr Sedan, 04-09	30
SKODA Octavia (M.k.II), 5-dr Hatchback, 04-09	30

3



480R Rapid Traverse



480 Traverse

(North America)

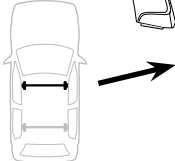

	X inch	X mm
SKODA Octavia (M.k.II), 4-dr Sedan, 04-09	38 ⁵/₈"	981 mm
SKODA Octavia (M.k.II), 5-dr Hatchback, 04-09	38 ⁵/₈"	981 mm

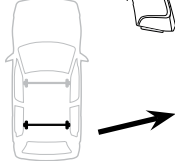

	Y inch	Y mm
SKODA Octavia (M.k.II), 4-dr Sedan, 04-09	37 ¹/₂"	951 mm
SKODA Octavia (M.k.II), 5-dr Hatchback, 04-09	37 ¹/₂"	951 mm

4

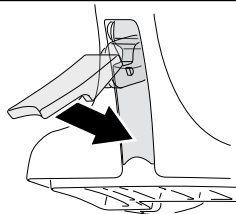

5

SKODA Octavia (M.k.II), 4-dr Sedan, 04-09

SKODA Octavia (M.k.II), 5-dr Hatchback, 04-09

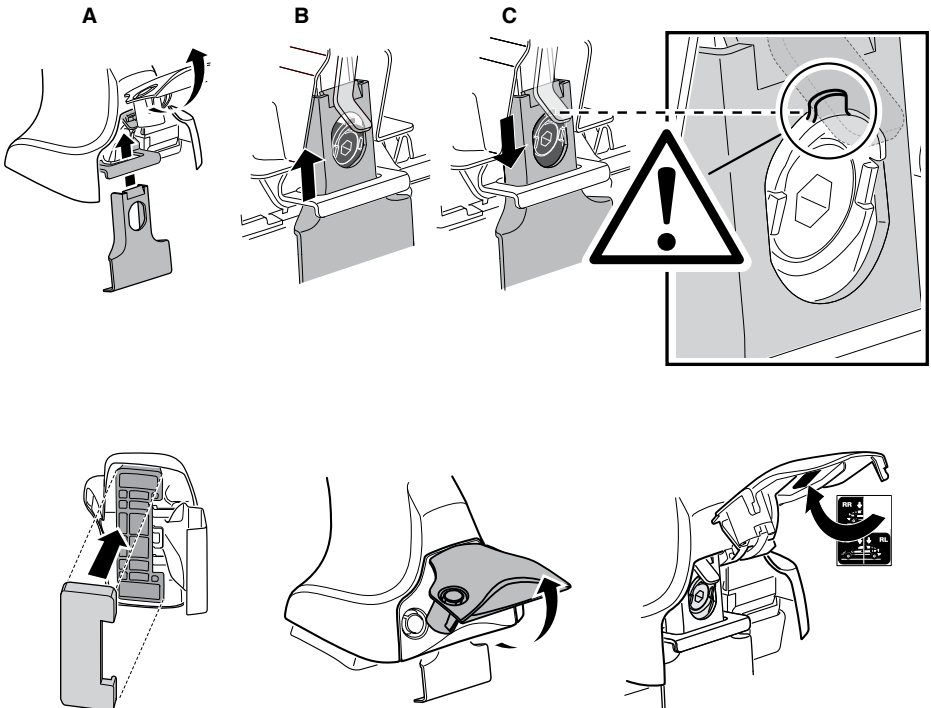
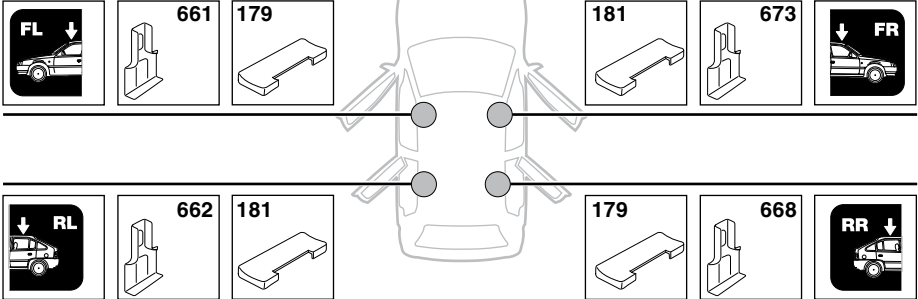

6

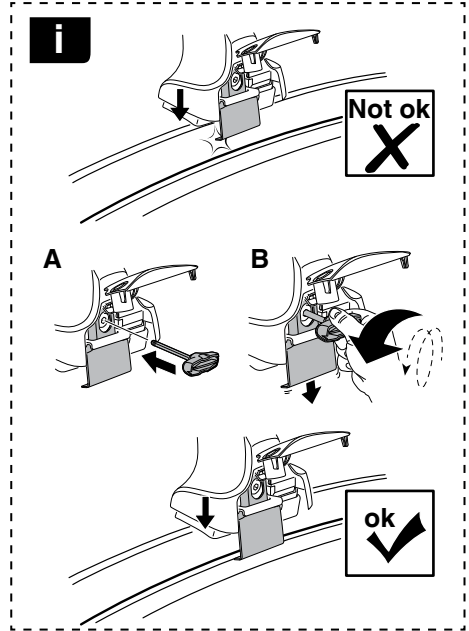
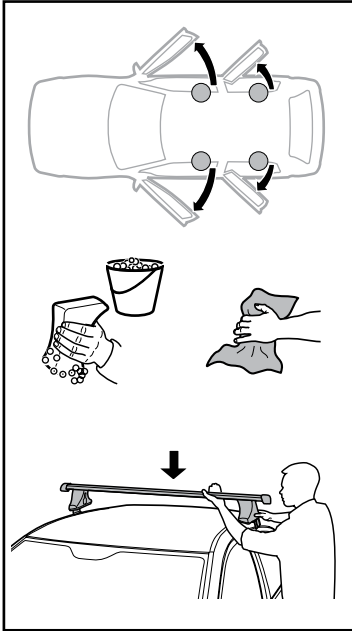

	X mm	Y mm	X inch	Y inch
SKODA Octavia (M.k.II), 4-dr Sedan, 04-09	235 mm	820 mm	9 1/4"	32 1/4"
SKODA Octavia (M.k.II), 5-dr Hatchback, 04-09	235 mm	820 mm	9 1/4"	32 1/4"

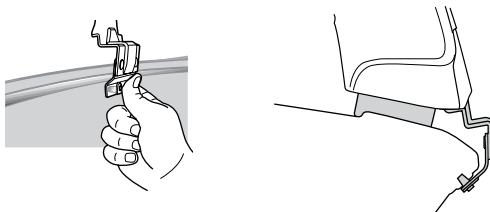
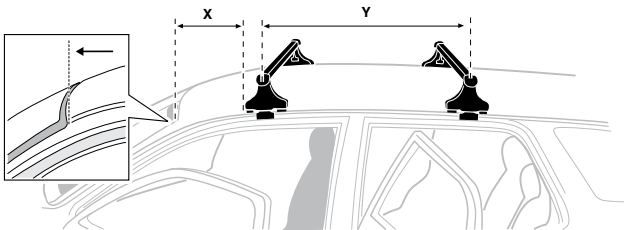

7

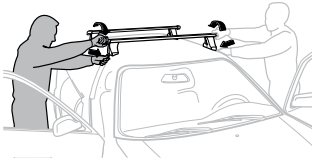

GB/US Tighten alternately
 D Die Schrauben abwechselnd anziehen
 F Serrer alternativement chaque côté
 NL Afwisselend aan de linker- en de rechterkant aandraaien
 I Alternare il serraggio delle viti
 E Apertar alternativamente
 PT Aperte alternadamente
 S Dra åt växelvis
 FIN Kierrä vuorotellen
 EST Pinguldage vaheldumisi
 LAT Pieļieciet pamišus
 LIT Užsukinėkite pakaitomis
 PL Śruby dokręcaj naprzemiennie
 RU Затягивайте попеременно

CZ Pokręťta bagażnika dokręcaj dokręcaj naprzemiennie.
 SK Dofahajte striedavo
 SLO Privijajte izmenično.
 HR Naizmjenočno zategnite
 HU Egymástól függetlenül szorítandó
 GR Σφιγίγες εναλλάξ
 TR Dönüşümlü sıkın

中文 交替拧紧

한국어 번갈아 가며 조이십시오.

日本語 交互に締め付けてください。

ไทย ชันในแบบสลับ

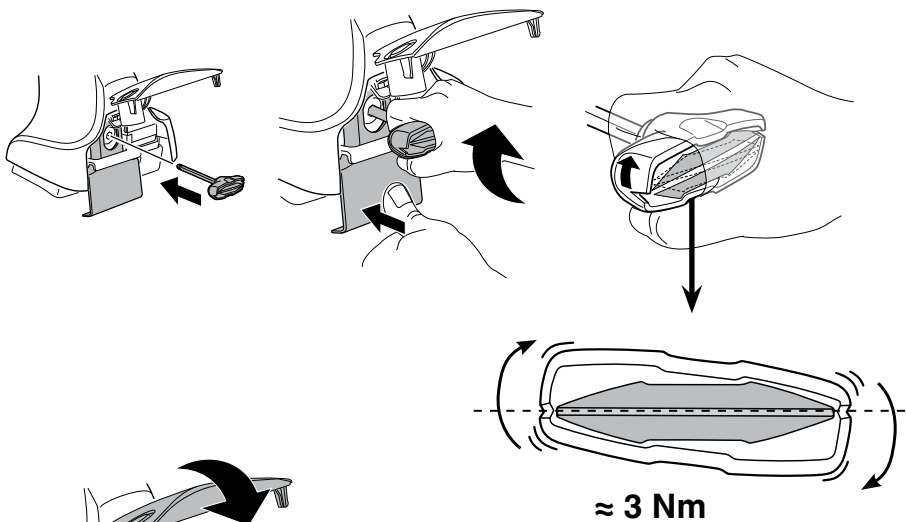

≈ 3 Nm

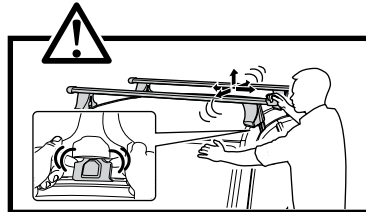

8



x1
17 mm

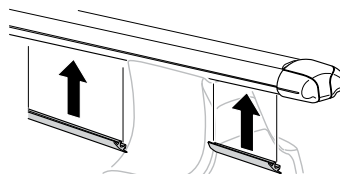
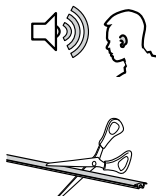

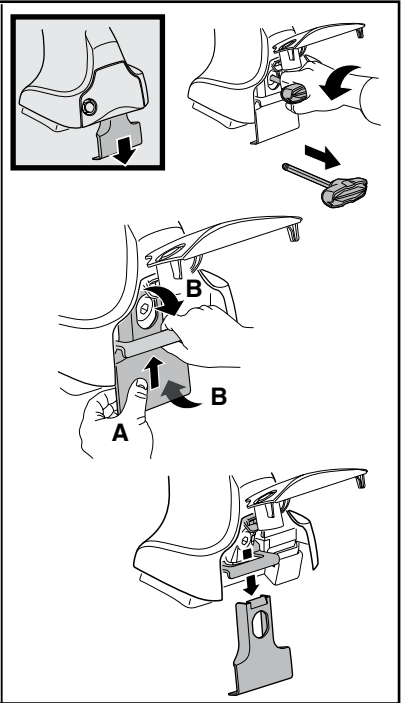
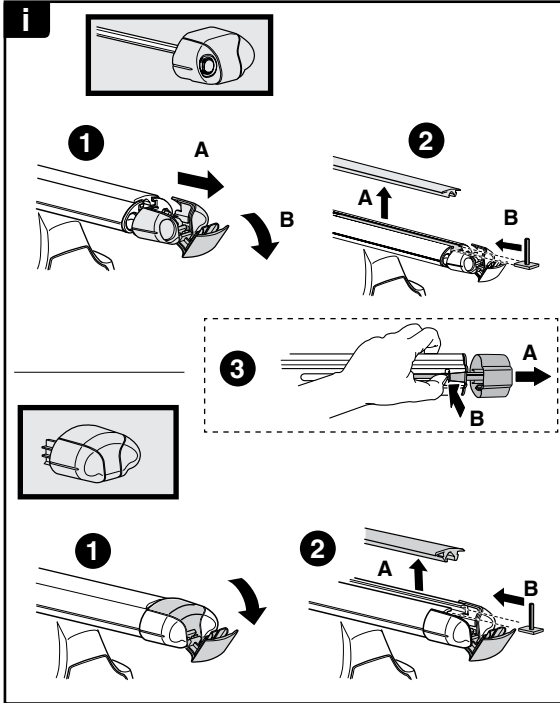

THULE
SWEDEN
**ONE
KEY
SYSTEM**



		(x4)
		(x6)
		(x8)
NA		(x10)
EUR		(x12)
ASIA		



WW ▶ Thule Sweden AB, Box 69, 330 33 Hillerstorp, SWEDEN
NA ▶ Thule Inc., 42 Silvermine Road, Seymour, Connecticut 06483, USA

info@thule.com
customer.service@thule.com

www.thule.com