



Vehicle Administration has, on the application of Hella Lighting Finland Oy, located in Salo, by virtue of the Decree of the Ministry of Transport and Communications (874/94) § 2 on Carrying into Effect the Agreement Concerning the Adoption of Uniform Conditions of Approval and Reciprocal Recognition of Approval for Motor Vehicle Equipment and Parts, decided on 6th of October, 1999, to grant the ECE approval for the registration plate lamp, model Talmu 14 1184-010, HLF 14 1184-070 and Hella 2VB 341 032-017 manufactured by the applicant, carrying approval number 00418 and complying with the ECE Regulation No. 4. Vehicle Administration has on 11th of February, 2000, corrected that ECE approval as specified in the enclosed Approval Certificate.

Each registration plate lamp meant by this type-approval must be equipped with markings required by the ECE Regulation in question.

The registration plate lamp devices marked with the approval number must correspond to the devices examined in tests on which this approval decision is based. The approval can be cancelled if it is found that the lamp devices carrying the approval number do not comply with the requirements of ECE Regulation No. 4.

The applicant is obligated to inform Vehicle Administration and the technical service responsible for conducting approval tests of changes intended for the registration plate lamp devices.

Helsinki, on 11th February, 2000

Head of Unit

Martti Lahti

Inspection Engineer

Anna Malkamäki

Charge FIM 1500,-

Hella Lighting Finland Oy
Inkereentie 566
24280 SALO

<i>Post address</i>	<i>Address</i>	<i>Telephone</i>	<i>Telefax</i>
<i>P.O. Box 120</i>	<i>Fabianinkatu 32</i>	<i>0100 7800</i>	<i>(09) 6185 3609</i>
<i>FIN-00101 Helsinki</i>	<i>Helsinki</i>	<i>Telephone int.</i>	<i>Telefax int.</i>
		<i>+358 100 7800</i>	<i>+358 9 6185 3609</i>



Date
11.2.2000

Dnr
181/209/2000

COMMUNICATION

L 00



concerning:

APPROVAL GRANTED
~~APPROVAL EXTENDED~~
~~APPROVAL REFUSED~~
~~APPROVAL WITHDRAWN~~
~~PRODUCTION DEFINITELY DISCONTINUED~~

of a type of rear registration plate lamp for wide plate
pursuant to Regulation No. 4

Approval No. 00418

~~Extension No.~~ Correction 01

- 1. Trade name or mark of the device: Talmu 14 1184-010
HLF 14 1184-070
Hella 2VB 341 032-017
- 2. Manufacturer's name for the type of device: rear combination lamp 1184 for trailers
- 3. Manufacturer's name and address: HELLA LIGHTING FINLAND OY
Inkereentie 566
FIN-24280 Salo
FINLAND
- 4. If applicable, name and address of the manufacturer's representative: n.a.
- 5. Submitted for approval on: 6.10.1999
- 6. Technical service responsible for conducting approval tests: Technical Research Centre
VTT Automation
Product Technology
Laboratory of Lighting Technology
P.O. Box 13051
FIN-02044 VTT, Finland
- 7. Date of test report issued by that service: 6.10.1999 and 30.12.1999
- 8. Number of test report issued by that service: AUT/TES/322/99

**Corrigendum to research report No.
AUT/TES/322/99**

Post address
P.O. Box 120
FIN-00101 Helsinki

Address
Fabianinkatu 32
Helsinki

Telephone
0100 7800
Telephone int.
+358 100 7800





Date
11.2.2000

Dnr
181/209/2000

9. Concise description:

Device for illuminating:

~~a tall plate;~~
a wide plate;
~~a plate for agricultural or forestry tractors~~

Number and category of filament lamp(s):

one lamp, C5W

10. Position of the approval mark:

on the lens, see drawings
No. 014359-00 and 014364-00

11. Reason(s) for extension (if applicable):

n.a.

12. Approval

granted/~~extended/refused/withdrawn~~

13. Place:

Helsinki

14. Date:

11.2.2000

15. Signature:

Martti Lahti
Head of Unit



16. The list of documents deposited with the Administrative Service which has granted approval is annexed to this communication and may be obtained on request.

Test report No. AUT/TES/322/99

Corrigendum to research report No. AUT/TES/322/99

Drawings No. 014359-00
014364-00
~~014361-00~~
014481-00

Remarks:

- 1) The rear registration plate lamp of grouped lamp (Talmu 14 1184-010, HLF 1184-070 or Hella 2VB 341 032-017) has to be mounted symmetrically as a pair according to the drawing No. ~~(014361-00)~~ **014481-00**.
- 2) **Reasons for correction 01:**
 - a) **An error in the research report AUT/TES/322/99 is corrected.**
 - b) **The drawing of the mounting dimensions is changed.**

L 00



418

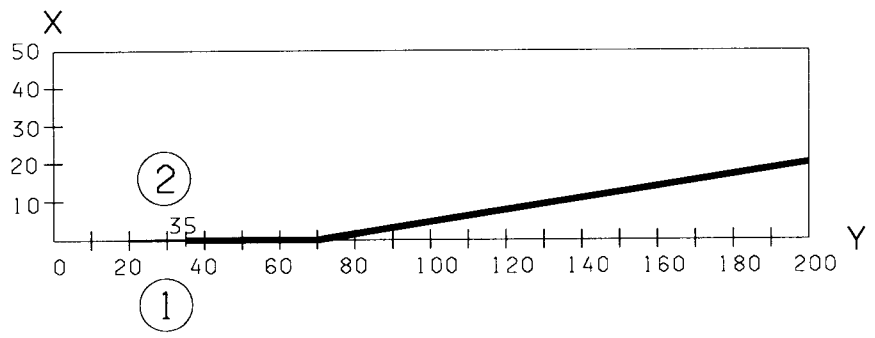
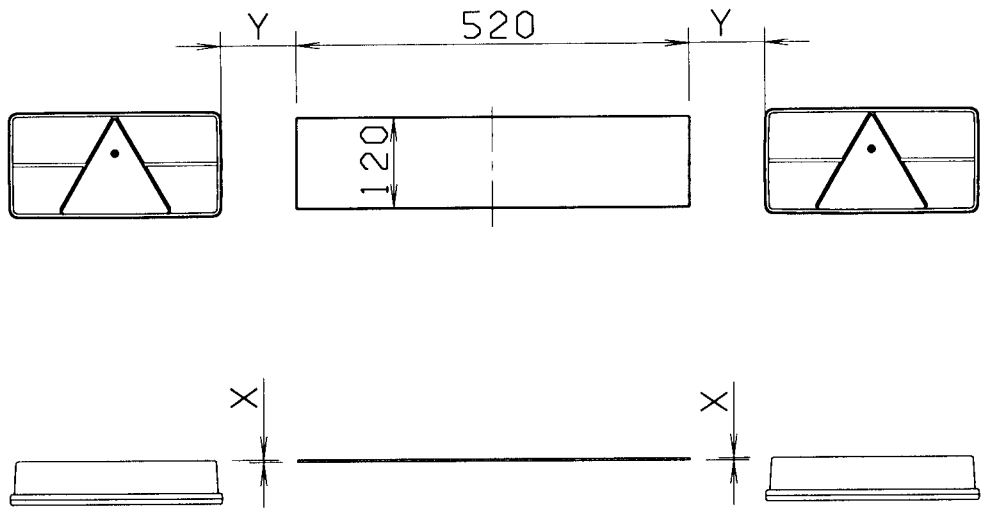

L 00

E 17

418

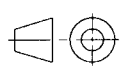
NO	DESIGN CHANGE	PLACE	DATE	SIGN	CHECK
2	index number changed to 35 (was 34)		09.02.00	EHA	PEI
1	index number changed to 34 (was 20)		17.01.00	EHA	PEI
SCALE	1:10	DRAWN	DATE	NAME	 OY TALMU AB FINLAND
ISO-E		EXAM.	10.11.1999	EHA	
		GROUP		TUKE	
PART NAME	MOUNTING DIMENSIONS FOR REG. PLATE LAMPS 1184				MODE H
		DRAWING NO	014481-00		ISO-A 4
		MCADAM			

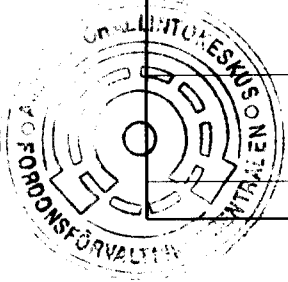



Vehicle Administration has, on the application of Hella Lighting Finland Oy, located in Salo, by virtue of the Decree of the Ministry of Transport and Communications (874/94) § 2 on Carrying into Effect the Agreement Concerning the Adoption of Uniform Conditions of Approval and Reciprocal Recognition of Approval for Motor Vehicle Equipment and Parts, decided to grant the ECE approval for the registration plate lamp, model Talmu 14 1184-010, HLF 14 1184-070 and Hella 2VB 341 032-017 manufactured by the applicant, carrying approval number 00418 and complying with the ECE Regulation No. 4 as specified in the enclosed Approval Certificate and Drawings No. 014359-00, 014364-00 and 014361-00.

Each registration plate lamp meant by this type-approval must be equipped with markings required by the ECE Regulation in question.

The registration plate lamp devices marked with the approval number must correspond to the devices examined in tests on which this approval decision is based. The approval can be cancelled if it is found that the lamp devices carrying the approval number do not comply with the requirements of ECE Regulation No. 4.

The applicant is obligated to inform Vehicle Administration and the technical service responsible for conducting approval tests of changes intended for the registration plate lamp devices.

Helsinki, on 6th October, 1999

Head of Unit

Martti Lahti

Inspection Engineer

Anna Malkamäki

Charge FIM 1000,-

Hella Lighting Finland Oy
Inkereentie 566
24280 SALO

Post address
P.O. Box 120
FIN-00101 Helsinki

Address
Fabianinkatu 32
Helsinki

Telephone
0100 7800
Telephone int.
+358 100 7800

Telefax
(09) 6185 3609
Telefax int.
+358 9 6185 3609



Date
6.10.1999

Dnr
2049/209-99

COMMUNICATION

L 00



418

concerning:

APPROVAL GRANTED
~~APPROVAL EXTENDED~~
~~APPROVAL REFUSED~~
~~APPROVAL WITHDRAWN~~
~~PRODUCTION DEFINITELY DISCONTINUED~~

of a type of rear registration plate lamp for wide plate
pursuant to Regulation No. 4

Approval No. 00418

Extension No. -

1. Trade name or mark of the device:

Talmu 14 1184-010
HLF 14 1184-070
Hella 2VB 341 032-017

2. Manufacturer's name for the type of device:

rear combination lamp 1184 for trailers

3. Manufacturer's name and address:

HELLA LIGHTING FINLAND OY
Inkereentie 566
FIN-24280 Salo
FINLAND

4. If applicable, name and address of the
manufacturer's representative:

n.a.

5. Submitted for approval on:

6.10.1999

6. Technical service responsible
for conducting approval tests:

Technical Research Centre
VTT Automation
Product Technology
Laboratory of Lighting Technology
P.O. Box 13051
FIN-02044 VTT, Finland

7. Date of test report issued by that service:

6.10.1999

8. Number of test report issued by that service:

AUT/TES/322/99

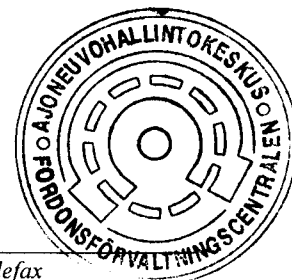

Post address
P.O. Box 120
FIN-00101 Helsinki

Address
Fabianinkatu 32
Helsinki

Telephone
0100 7800
Telephone int.
+358 100 7800

Telefax
(09) 6185 3609
Telefax int.
+358 9 6185 3609



Date
6.10.1999

Dnr
2049/209-99

9. Concise description:

Device for illuminating:

~~a tall plate;~~
a wide plate;
~~a plate for agricultural or forestry tractors~~

Number and category of filament lamp(s):

one lamp, C5W

10. Position of the approval mark:

on the lens, see drawings
No. 014359-00 and 014364-00

11. Reason(s) for extension (if applicable):

n.a.

12. Approval

granted/~~extended/refused/withdrawn~~

13. Place:

Helsinki

14. Date:

6.10.1999

15. Signature:

Martti Lahti
Head of Unit



16. The list of documents deposited with the Administrative Service which has granted approval is annexed to this communication and may be obtained on request.

Test report No. AUT/TES/322/99

Drawings No. 014359-00
014364-00
014361-00

Remarks:

The rear registration plate lamp of grouped lamp (Talmu 14 1184-010, HLF 1184-070 or Hella 2VB 341 032-017) has to be mounted symmetrically as a pair according to the drawing No.014361-00.

L 00



418

registration plate lamp
 colour: clear
 lamp: C5W

rear fog lamp
 colour: red
 lamp: P21W

direction indicator
 category 2a
 colour: amber
 lamp: P21W

triangular retro reflector
 class IIIA
 colour: red

rear position (side) lamp
 reciprocally incorporated with stop lamp
 category S1
 colour: red
 lamp: P21/5W

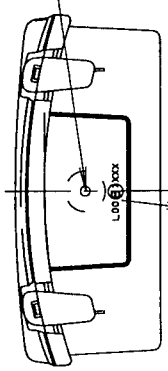

L00 E7 XXX

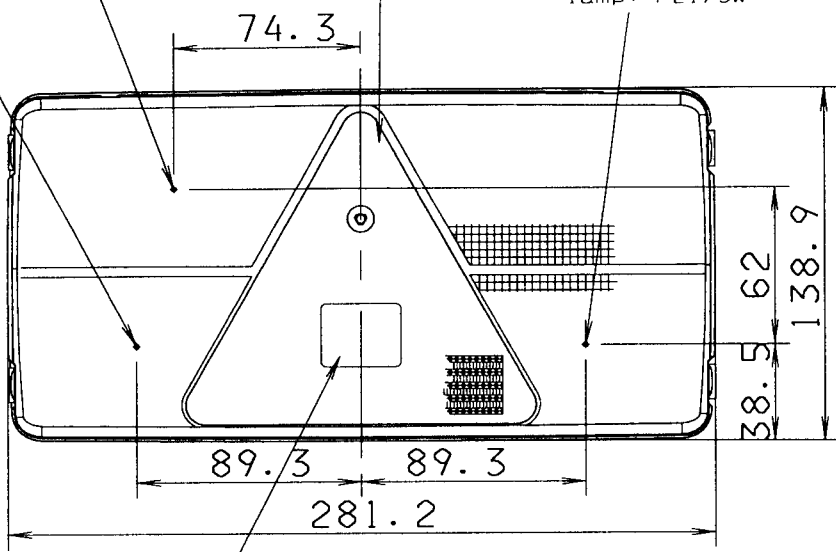

1:1

area for markings

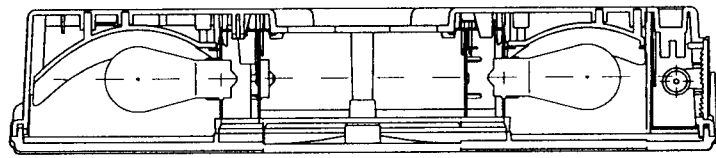
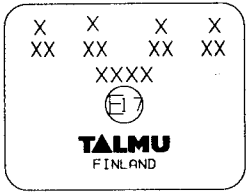

Left side for RH traffic
 Right side for LH traffic
 Another side mirror image for this side

PRODUCT NUMBER: 14 1184-010

L 00
 E 17
 418

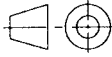
SCALE	1:3	DRAWN	27.05.1999	NAME	EHA	 OY TALMU AB FINLAND
ISO-E		EXAM.	07.09.1999	NAME	JNI	
		GROUP		NAME	TUKE	
PART NAME						MODE
REAR COMBINATION LAMP 1184 LEFT Talmu						H
DRAWING NO					ISO-A	
014359-00					4	
MCADAM						



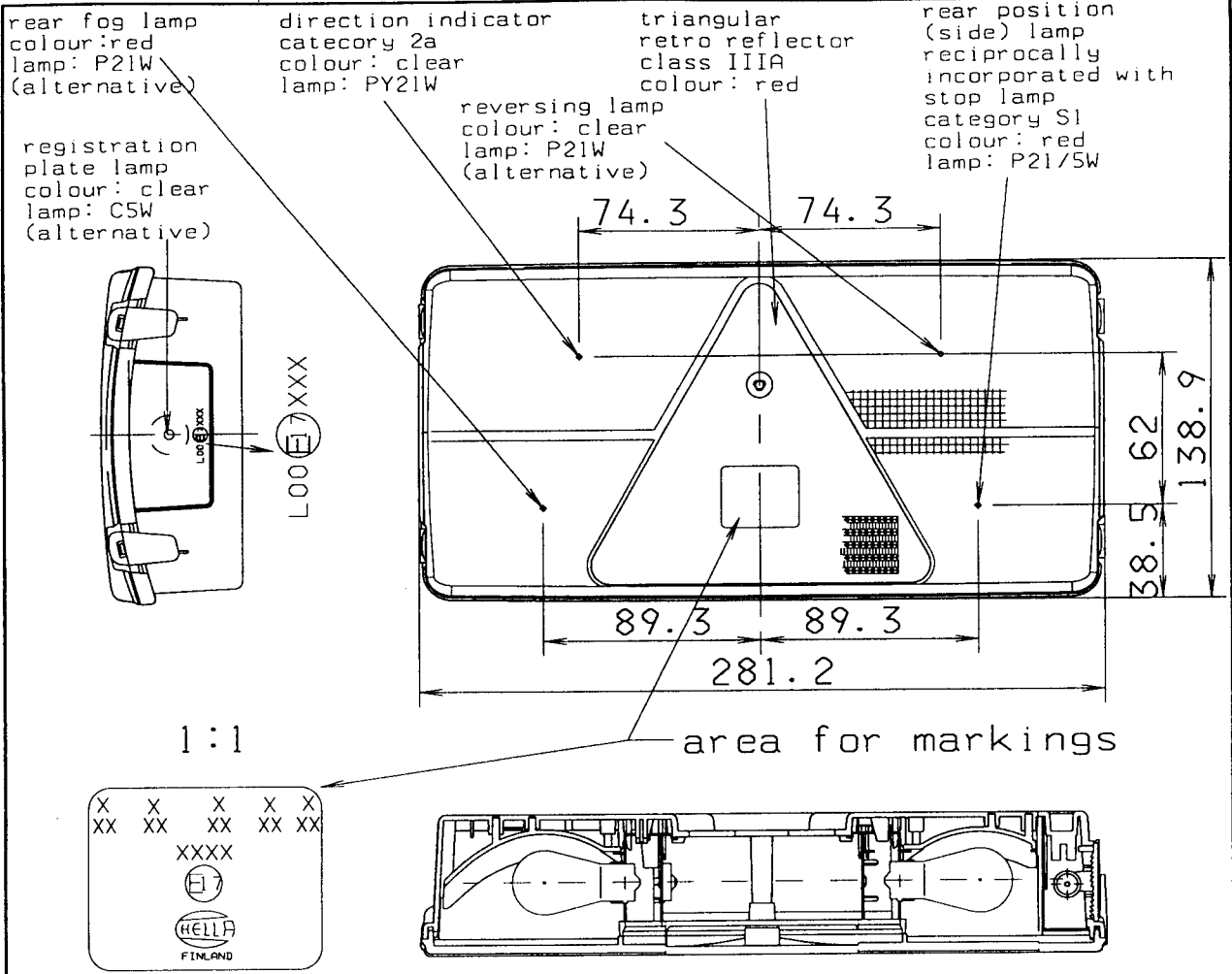

Left side for RH traffic
Right side for LH traffic
Another side mirror image for this side

PRODUCT NUMBER: 14 1184-070 HLF
2VB 341 032-017 Hella

L 00
E 17
418

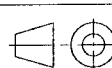
SCALE	1:3	DRAWN	28.05.1999	DATE	28.05.1999	NAME	EHA	 OY TALMU AB FINLAND
ISO-E		EXAM.	07.09.1999	DATE	07.09.1999	NAME	JNI	
		GROUP				NAME	TUKE	
PART NAME								MODE
REAR COMBINATION LAMP 1184 LEFT Hella								H
DRAWING NO							ISO-A	
014364-00							4	
MCADAM								



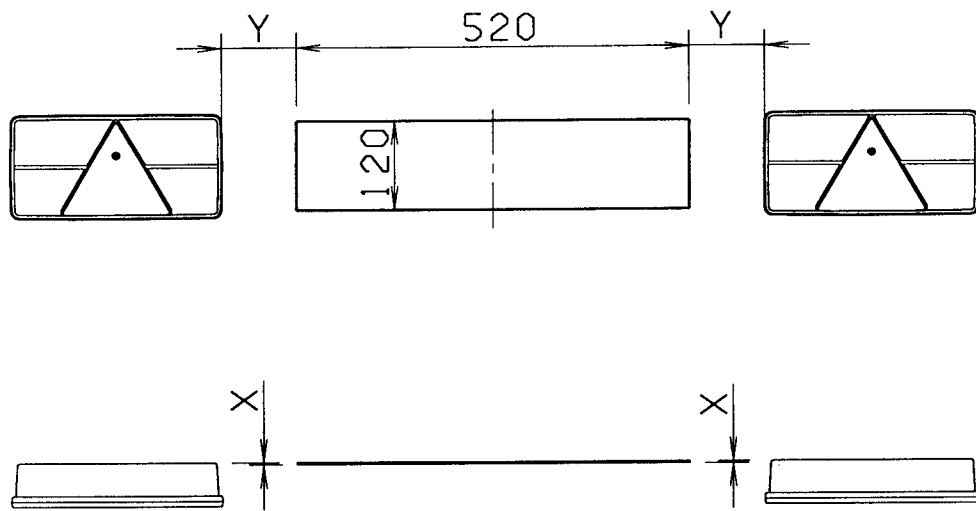

Y	20-200
X	0

L 00

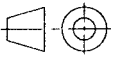

418

SCALE	1 : 10	DATE	27. 05. 1999	NAME	EHA	 OY TALMU AB FINLAND	
ISO-E		EXAM.					
		GROUP		TUKE			
PART NAME	MOUNTING DIMENSIONS FOR REG. PLATE LAMPS 1184					MODE	H
				DRAWING NO	014361-00	ISO-A	4
				MCADAM			

