



1296-M022-0_P

ER250R

INSTRUCTION MANUAL

GB

TRANSLATION FROM THE
ORIGINAL INSTRUCTIONS

For spare parts drawings refer to the section "LIST OF COMPONENTS" enclosed to this manual.

- For any further information please contact your local dealer or call:

Technical services: **SPACE s.r.l. a s.u.** - Via Sangano, 48 - 10090 Trana - Torino Italy
Phone (+39) 011 93440300 - Fax (+39) 011 9338864 - e-mail: spacesrl@tin.it

1296-M022-0_P - Rev. n. 0 (01/2020)

SUMMARY

GENERAL DESCRIPTION _____	4		
SYMBOLS USED IN THE MANUAL _____	5		
INFORMATION PLATE LOCATION TABLE _____	6		
1.0 GENERAL INTRODUCTION _____	7		
1.1 <i>Introduction</i> _____	7		
2.0 INTENDED USE _____	7		
2.1 <i>Training of personnel</i> _____	7		
3.0 SAFETY DEVICES _____	8		
3.1 <i>Residual risks</i> _____	8		
4.0 GENERAL SAFETY RULES _____	8		
5.0 PACKING AND MOBILIZATION FOR TRANSPORT _____	9		
6.0 UNPACKING _____	10		
7.0 MOBILIZATION _____	10		
8.0 WORKING ENVIRONMENT CONDITIONS _____	11		
8.1 <i>Working area</i> _____	11		
8.2 <i>Lighting</i> _____	11		
9.0 MACHINE ASSEMBLY _____	12		
9.1 <i>Anchoring system</i> _____	12		
9.2 <i>Fixtures contained in the packing</i> _____	12		
9.3 <i>Assembly procedures</i> _____	13		
9.3.1 <i>Fitting the shaft on the flange</i> _____	13		
9.3.2 <i>Fitting the protection guard (without width measuring device)</i> _____	13		
9.3.3 <i>Monitor fitting</i> _____	14		
9.3.4 <i>Fitting of external data gauge (optional)</i> _____	15		
10.0 ELECTRICAL CONNECTIONS _____	16		
10.1 <i>Electrical checks</i> _____	16		
11.0 FITTING THE WHEEL ON THE SHAFT _____	17		
11.1 <i>Wheel assembly</i> _____	17		
12.0 CONTROL PANEL _____	18		
13.0 WHEEL BALANCING _____	18		
13.1 <i>Switching the machine on and off</i> _____	18		
13.2 <i>Balancing programs setting</i> _____	19		
13.2.1 <i>Programs rapid setting and measurements through distance- diameter caliper arm</i> _____	20		
13.2.2 <i>Programs setting through "Measurements acquisition" screen page</i> _____	22		
13.3 <i>Indicative display of points where to detect measures/to fit weight</i> _____	23		
13.3.1 <i>Weights positioning</i> _____	24		
13.4 <i>Displaying the active/modifiable field</i> _____	24		
13.5 <i>Wheel balancing screen page description</i> _____	25		
13.5.1 <i>Balancing mode</i> _____	27		
13.6 <i>Use of machines with disabled auto- matic data gauge</i> _____	28		
13.6.1 <i>Manual setting of wheel dimensions</i> _____	28		
13.7 <i>Standard balancing programs</i> _____	28		
13.7.1 <i>Static</i> _____	28		
13.7.2 <i>Static-1</i> _____	29		
13.7.3 <i>Static-2</i> _____	29		
13.7.4 <i>Dynamic</i> _____	29		
13.7.5 <i>ALU-S</i> _____	29		
13.7.6 <i>ALU-S1</i> _____	30		
13.7.7 <i>ALU-S2</i> _____	30		
13.7.8 <i>ALU-1</i> _____	30		
13.7.9 <i>ALU-2</i> _____	30		
13.7.10 <i>ALU-3</i> _____	31		
13.7.11 <i>ALU-4</i> _____	31		
13.8 <i>Optional balancing programs</i> _____	31		
13.8.1 <i>ECO-WEIGHT mode</i> _____	31		
13.8.2 <i>SPLIT mode</i> _____	33		
13.8.3 <i>Weights hidden behind spokes mode</i> _____	35		
13.8.4 <i>Matching mode</i> _____	36		
13.9 <i>Special balancing programs</i> _____	39		
13.9.1 <i>Pax</i> _____	39		
13.10 <i>Recalculation function</i> _____	39		
13.11 <i>Wheel balancing in Motorcycle mode (with distance caliper extension Kit)</i> _____	40		
14.0 USER MENU (OPTIONS AND CALIBRATION) _____	40		
14.1 <i>Options menu</i> _____	41		
14.1.1 <i>Lower weight limit</i> _____	42		
14.1.2 <i>Setting adhesive weight dimen- sions and static threshold per- centage</i> _____	43		
14.1.3 <i>User management</i> _____	43		
14.2 <i>Machine calibrations</i> _____	44		
14.2.1 <i>Chuck "0" (zero) calibration</i> _____	44		
14.2.2 <i>Weight measurement sensors calibration</i> _____	45		
14.2.3 <i>Gauge calibration</i> _____	46		
15.0 ERROR SIGNALS _____	50		

16.0 ROUTINE MAINTENANCE _____ 51**17.0 TECHNICAL DATA _____ 52****17.1 Technical electrical data _____ 52****17.2 Technical mechanical data _____ 52****17.3 Dimensions _____ 53****18.0 STORING _____ 54****19.0 SCRAPPING _____ 54****20.0 REGISTRATION PLATE DATA _____ 54****21.0 FUNCTIONAL DIAGRAMS _____ 54****Table A - Electrical connection diagram ____ 55**

GENERAL DESCRIPTION

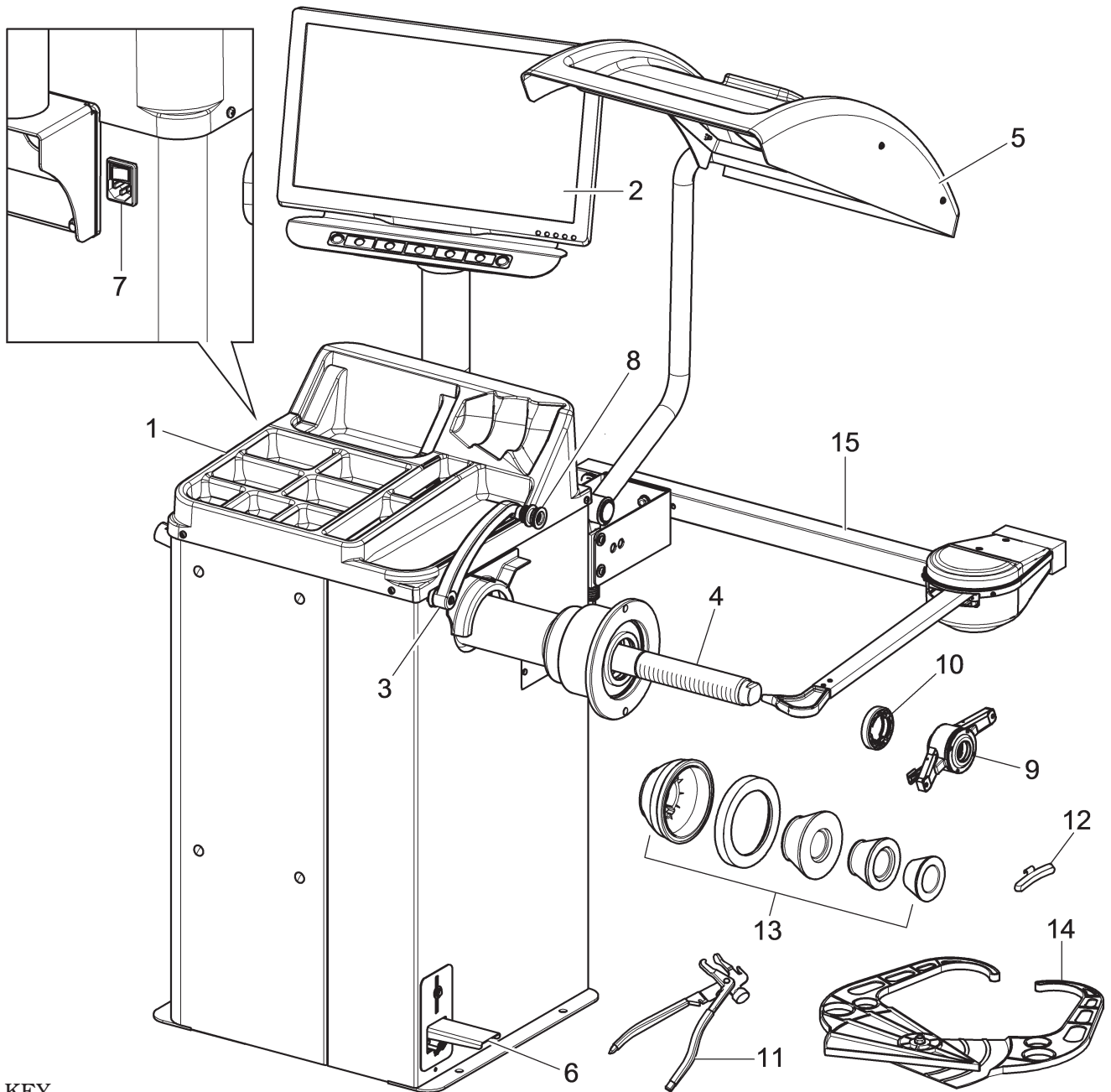











KEY

- 1 - Weight holding bridge
- 2 - Monitor
- 3 - Distance caliper
- 4 - Threaded shaft
- 5 - Protection guard
- 6 - Pedal brake
- 7 - Main switch
- 8 - Grippers for weight fitting
- 9 - Rapid ring nut
- 10 - Pressure ring
- 11 - Grippers for weights
- 12 - Carriages counterweight
- 13 - Cones + protection cup
- 14 - Manual caliper
- 15 - Rim width measuring device (optional)

Fig. 1

SYMBOLS USED IN THE MANUAL

Symbols	Description
	Read instruction manual.
	Wear work gloves.
	Wear work shoes.
	Wear safety goggles.
	Warning. Be particularly careful (possible material damages).
	Mandatory. Operations or jobs to be performed compulsorily.

Symbols	Description
	Danger! Be particularly careful.
	Move with fork lift truck or pallet truck.
	Lift from above.
	Note. Indication and/or useful information.
	Attention: never lift the machine by means of the chuck.

INFORMATION PLATE LOCATION TABLE

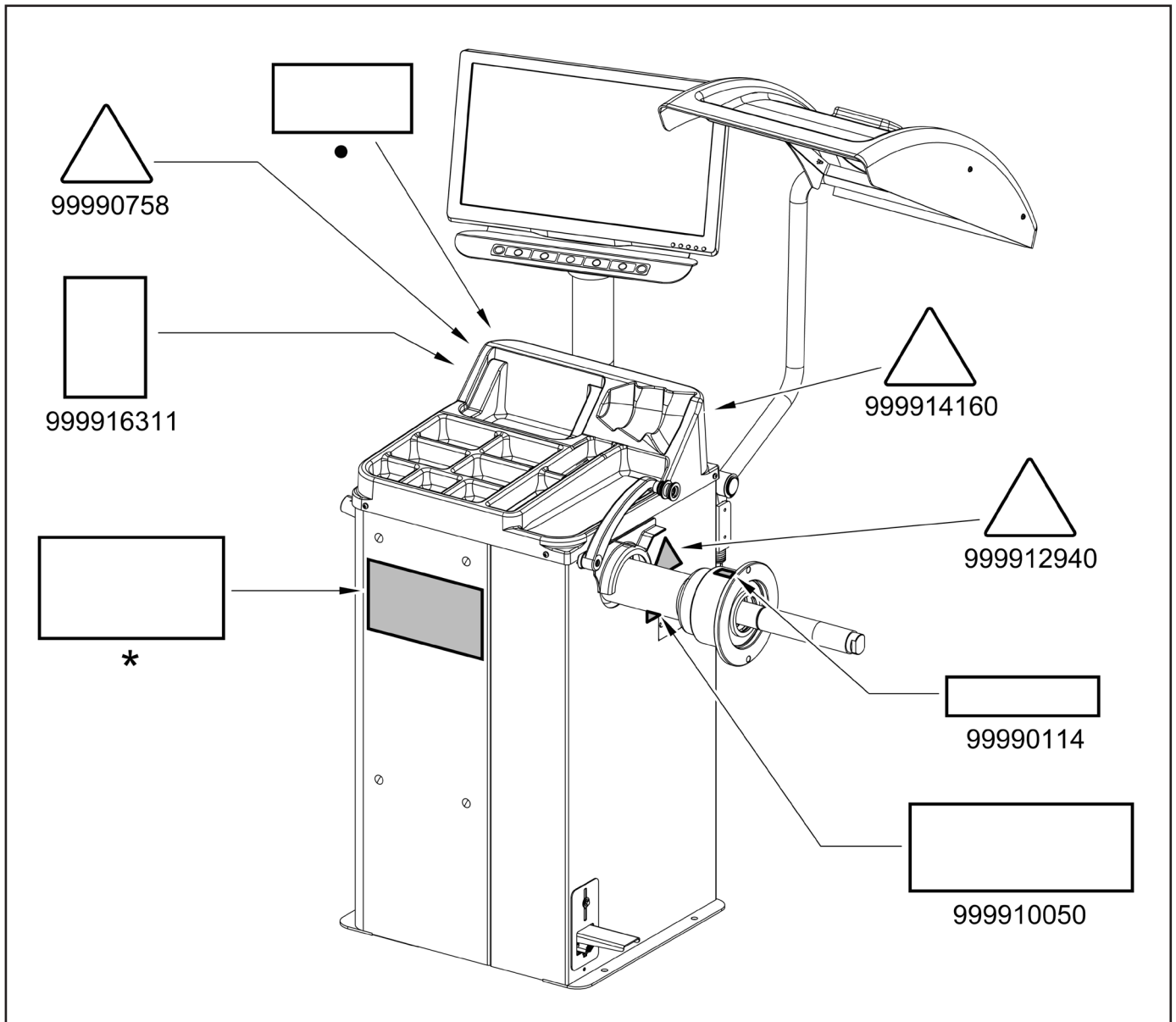

Code numbers of plates

99990114	<i>Arrow plate</i>
99990758	<i>Electricity danger plate</i>
999910050	<i>Protection device use plate</i>
999912940	<i>Lifting plate</i>
999914160	<i>Voltage 230V 50/60 Hz 1 Ph plate</i>
999916311	<i>Rubbish skip plate</i>
.	<i>Serial number plate</i>
*	<i>Manufacturer plate</i>



IF ONE OR MORE PLATES DISAPPEAR FROM THE MACHINE OR BECOMES DIFFICULT TO READ. REPLACE IT AND QUOTE ITS/THEIR CODE NUMBER/S WHEN REORDERING.



SOME OF THE PICTURES AND/OR DISPLAY SCREEN PAGES PRESENT IN THIS MANUAL HAVE BEEN OBTAINED FROM PICTURES OF PROTOTYPES, THEREFORE THE STANDARD PRODUCTION MACHINES AND ACCESSORIES CAN BE DIFFERENT IN SOME COMPONENTS/DISPLAY SCREEN PAGES.

1.0 GENERAL INTRODUCTION

This manual is an integral part of the product and must be retained for the whole operating life of the machine.

Carefully study the warnings and instructions contained in this manual. It contains important instructions regarding **FUNCTIONING, SAFE USE and MAINTENANCE.**



KEEP THE MANUAL IN A KNOWN, EASILY ACCESSIBLE PLACE FOR ALL ACCESSORY OPERATORS TO CONSULT IT WHENEVER IN DOUBT.



THE MANUFACTURER DISCLAIMS ALL RESPONSIBILITY FOR ANY DAMAGE OCCURRED WHEN THE INDICATIONS GIVEN IN THIS MANUAL ARE NOT RESPECTED: AS A MATTER OF FACT, THE NON-COMPLIANCE WITH SUCH INDICATIONS MIGHT LEAD TO EVEN SERIOUS DANGERS.

1.1 Introduction

Thank you for preferring this wheel balancer. We feel sure you will not regret your decision.

This machine has been designed for use in professional workshops and stands out for its reliability and easy, safe and rapid operation. With just a small degree of maintenance and care, this wheel balancer will give you many years of trouble-free service and lots of satisfaction.

2.0 INTENDED USE

The machine described in this manual, and their different versions, is a wheel balancing machine for car and light transport, projected to be used exclusively to cancel out, or at least reduce to acceptable limits the vibrations of the wheels, by fitting counterweights, of suitable size and in specific positions to the wheels that are not correctly balanced.



EMPLOYING THIS MACHINE OUTSIDE THE USE DESTINATION IT HAS BEEN DESIGNED FOR (AS INDICATED IN THIS MANUAL) IS INAPPROPRIATE AND DANGEROUS.



THE MANUFACTURER CANNOT BE HELD RESPONSIBLE FOR ANY DAMAGE CAUSED BY IMPROPER, ERRONEOUS, OR UNACCEPTABLE USE.

2.1 Training of personnel

The machine may be operated only by suitably trained and authorized personnel.

Given the complexity of the operations necessary to manage the machine and to carry out the operations safely and efficiently, the personnel must be trained in such a way that they learn all the information necessary to operate the machine as intended by the manufacturer.



A CAREFUL READING OF THIS INSTRUCTION MANUAL FOR USE AND MAINTENANCE AND A SHORT PERIOD OF TRAINING WITH SKILLED PERSONNEL CAN BE AN ENOUGH PREVENTIVE PREPARATION.

3.0 SAFETY DEVICES



PERIODICALLY, AT LEAST MONTHLY, CHECK THE INTEGRITY AND THE FUNCTIONALITY OF THE SAFETY AND PROTECTION DEVICES ON THE MACHINE.

- **Controls logic disposition**

Its function is to prevent the operator from dangerous mistakes.

- **Master switch positioned on the rear of the machine**

Its function is to disconnect machine electric supply.

- **Protection guard**

Its function is to protect the operator from possible projections of materials on the wheel during its spin. Wheel spinning is normally prevented if the wheel protection guard is raised (open). When the protection guard is open, this interrupts the circuit that triggers the motor and automatic start is prevented, including in the case of an error.



Press  key to stop wheel in emergency conditions.

3.1 Residual risks

The machine was subjected to a complete analysis of risks according to reference standard EN ISO 12100. Risks are as reduced as possible in relation with technology and product functionality.

Possible residual risks have been emphasized through pictorial representations and warnings which placing is indicated in "PLATE POSITIONING TABLE" at page 6.

4.0 GENERAL SAFETY RULES



- Any tampering with or modification to the machine not previously authorized by the manufacturer exempts the latter from all responsibility for damage caused by or derived from said actions.
- Removing of or tampering with the safety devices or with the warning signals placed on the machine leads to serious dangers and represents a transgression of European safety rules.
- Use of the machine is only permitted in places free from **explosion** or **fire** hazard and in **dry places under cover**.
- Original spare parts and accessories should be used.



THE MANUFACTURER DENIES ANY RESPONSIBILITY IN CASE OF DAMAGES CAUSED BY UNAUTHORIZED MODIFICATIONS OR BY THE USE OF NON ORIGINAL COMPONENTS OR EQUIPMENT.

- Installation must be conducted only by qualified personnel exactly according to the instructions that are given below.
- Ensure that there are no dangerous situations during the machine operating manoeuvres. Immediately stop the machine if it miss-functions and contact the assistance service of an authorized dealer.
- In emergency situations and before carrying out any maintenance or repairs, disconnect all supplies to the machine by using the main switch, placed on the machine itself, and unplugging the power supply.
- The machine electrical supply system must be equipped with an appropriate earthing, to which the yellow-green machine protection wire must be connected.
- Ensure that the work area around the machine is free of potentially dangerous objects and that there is no oil since this could damage the tyre. Oil on the floor is also a potential danger for the operator.
- **UNDER NO CIRCUMSTANCES** must the machine be used to spin anything but vehicle wheels. Bad locking can cause rotating parts to come loose, with potential damage to the machine and anything in the vicinity and injury to the operator.



OPERATORS MUST WEAR SUITABLE WORK CLOTHES, PROTECTIVE GLASSES AND GLOVES, AGAINST THE DANGER FROM THE SPRAYING OF DANGEROUS DUST, AND POSSIBLY LOWER BACK SUPPORTS FOR THE LIFTING OF HEAVY PARTS. DANGLING OBJECTS LIKE BRACELETS MUST NOT BE WORN, AND LONG HAIR MUST BE TIED UP. FOOTWEAR SHOULD BE ADEQUATE FOR THE TYPE OF OPERATIONS TO BE CARRIED OUT.

- The machine handles and operating grips must be kept clean and free from oil.
- The workshop must be kept clean and dry. Make sure that the working premises are properly lit. The machine can be operated by a single operator. Unauthorized personnel must remain outside the working area, as shown in **Fig. 3**. Avoid any hazardous situations. Do not use air-operated or electrical equipment when the shop is damp or the floor slippery and do not expose such tools to atmospheric agents.
- When operating and servicing this machine, carefully follow all applicable safety and accident-prevention precautions. The machine must not be operated by untrained personnel.

5.0 PACKING AND MOBILIZATION FOR TRANSPORT



HAVE THE MACHINE HANDLED BY SKILLED PERSONNEL ONLY.

THE LIFTING EQUIPMENT MUST WITHSTAND A MINIMUM RATED LOAD EQUAL TO THE WEIGHT OF THE PACKED MACHINE (SEE PARAGRAPH "TECHNICAL SPECIFICATIONS").

The machine is packed partially assembled. Movement must be by pallet-lift or fork-lift trolley. The fork lifting points are indicated on the packing.

Fig. 2

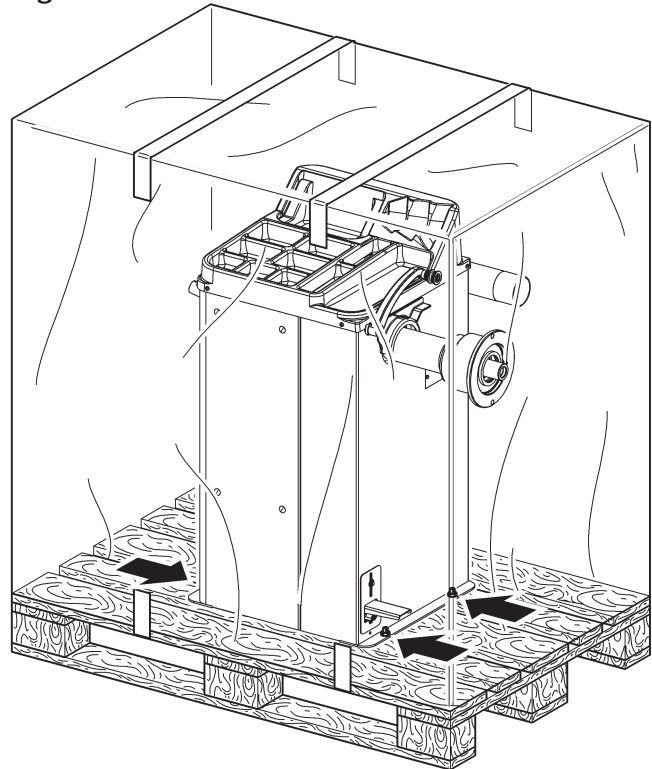

6.0 UNPACKING



DURING UNPACKING, ALWAYS WEAR GLOVES TO PREVENT ANY INJURY CAUSED BY CONTACT WITH PACKAGING MATERIAL (NAILS, ETC.).



The cardboard box is supported with plastic strapping. Cut the strapping with suitable scissors. Use a small knife to cut along the lateral axis of the box and open it like a fan.

It is also possible to unnailed the cardboard box from the pallet it is fixed to. After removing the packing, and in the case of the machine packed fully assembled, check that the machine is complete and that there is no visible damage.

If in doubt **do not use the machine** and refer to professionally qualified personnel (to the seller).

The packing (plastic bags, expanded polystyrene, nails, screws, timber, etc.) should not be left within reach of children since it is potentially dangerous. These materials should be deposited in the relevant collection points if they are pollutants or non biodegradable.



THE BOX CONTAINING THE FIXTURES IS CONTAINED IN THE WRAPPING. DO NOT THROW IT AWAY WITH THE PACKING.

7.0 MOBILIZATION



THE LIFTING EQUIPMENT MUST WITHSTAND A MINIMUM RATED LOAD EQUAL TO THE WEIGHT OF THE MACHINE (SEE PARAGRAPH TECHNICAL SPECIFICATIONS). DO NOT ALLOW THE LIFTED MACHINE TO SWING.



NEVER LIFT THE MACHINE BY MEANS OF THE CHUCK.

If the machine has to be moved from its normal work post, the movement must be conducted following the instructions listed below.

- Protect the exposed corners with suitable material (Pluribol/cardboard).
- Do not use metallic cables for lifting.
- Make sure that the electricity supply is not connected.
- Place again the machine onto the original pallet with whom it was delivered.
- Use transpallet or fork-lift for handling.

8.0 WORKING ENVIRONMENT CONDITIONS

The machine must be operated under proper conditions as follows:

- temperature: 0° + 45° C
- relative humidity: 30 - 90% (dew-free)
- atmospheric pressure: 860 - 1060 hPa (mbar).

The use of the machine in ambient conditions other than those specified above is only allowed after prior agreement with and approval of the manufacturer.

8.1 Working area

Fig. 3

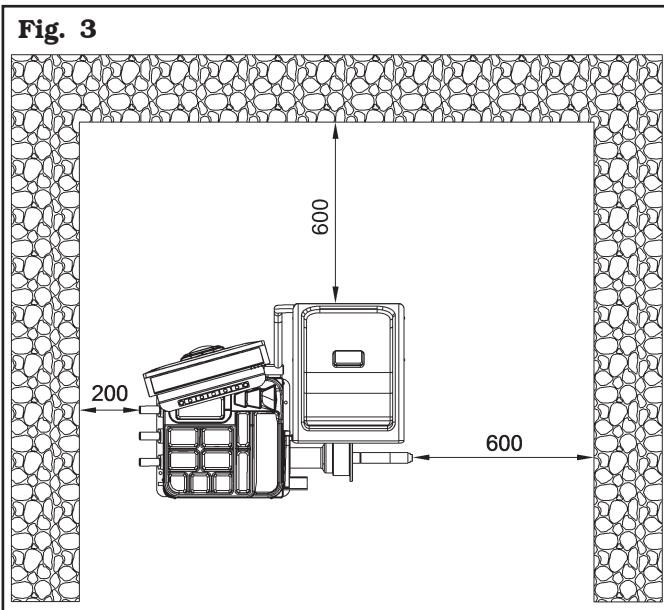

USE THE MACHINE IN A DRY AND ADEQUATELY LIT PLACE, POSSIBLY INDOORS OR ANYWAY IN A ROOFED AREA, THIS PLACE MUST BE IN COMPLIANCE WITH APPLICABLE SAFETY REGULATIONS.

The location of the machine requires a usable space as indicated in **Fig. 3**. The positioning of the machine must be according to the distances shown. From the control position the operator is able to observe all the machine and surrounding area. He must prevent unauthorized personnel or objects that could be dangerous from entering the area. The machine must be fixed on a flat floor surface, preferably of cement or tiled. Avoid yielding or irregular surfaces.

The base floor must be able to support the loads transmitted during operation.

This surface must have a capacity load of at least 500 kg/m².

The depth of the solid floor must be sufficient to guarantee that the anchoring bolts hold.

8.2 Lighting

The machine does not require its own lighting for normal working operations. However, it must be used in an adequately lit environment.

In case of poor lighting use lamps having total power of 800/1200 Watt.

9.0 MACHINE ASSEMBLY

After having freed the various components from the packing check that they are complete, and that there are no anomalies, then comply with the following instructions for the assembly of the components making use of the attached series of illustrations.

9.1 Anchoring system

The packed machine is fixed to the support pallet through the holes prearranged on the frame. Such holes can be used also to fix the machine to the ground, through floor anchor small blocks (excluded from supply). Before carrying out the definitive fixing, check that all the anchor points are laid down flat and correctly in contact with the fixing surface itself. If not so, insert shimming profiles between the machine and the fixing lower surface, as indicated in **Fig. 4**.



IN CASE OF WHEEL WEIGHING MORE THAN 30 KG, IT IS COMPULSORY TO FIX TO THE GROUND BY MEANS OF SCREW ANCHORS.

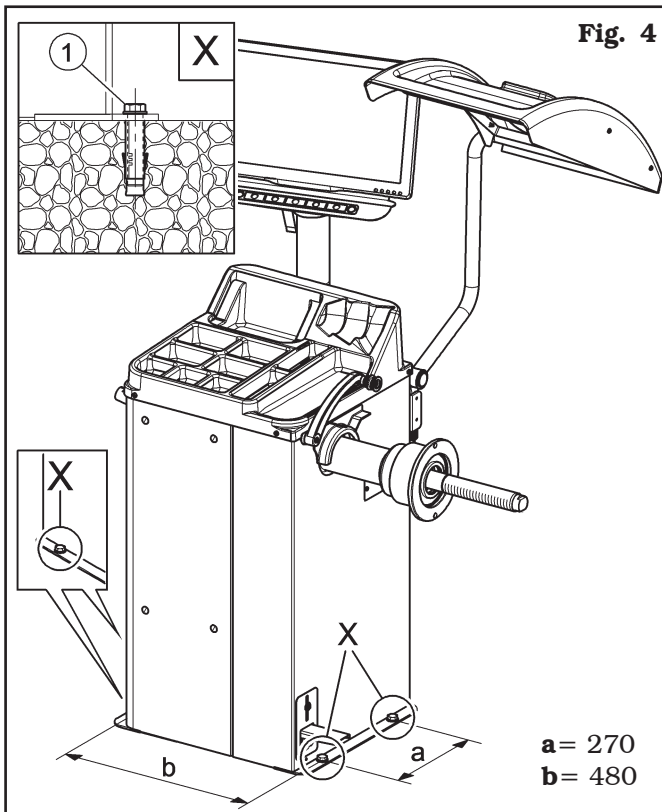

- Execute 4 holes with 10 mm diameter on the floor by the holes on the bottom floor;
- insert the small blocks (excluded from supply) into the holes;
- fix the machine to the ground with 4 M8x80 mm screws (excluded from supply) (**Fig. 4 ref. 1**) (or with 4 8x80 mm stud bolts (excluded from supply)). Tighten the screws with an approximate tightening torque of 70 Nm.

9.2 Fixtures contained in the packing

The packing case contains also the fixtures box. Check that all the parts listed below are there (see **Fig. 5**).

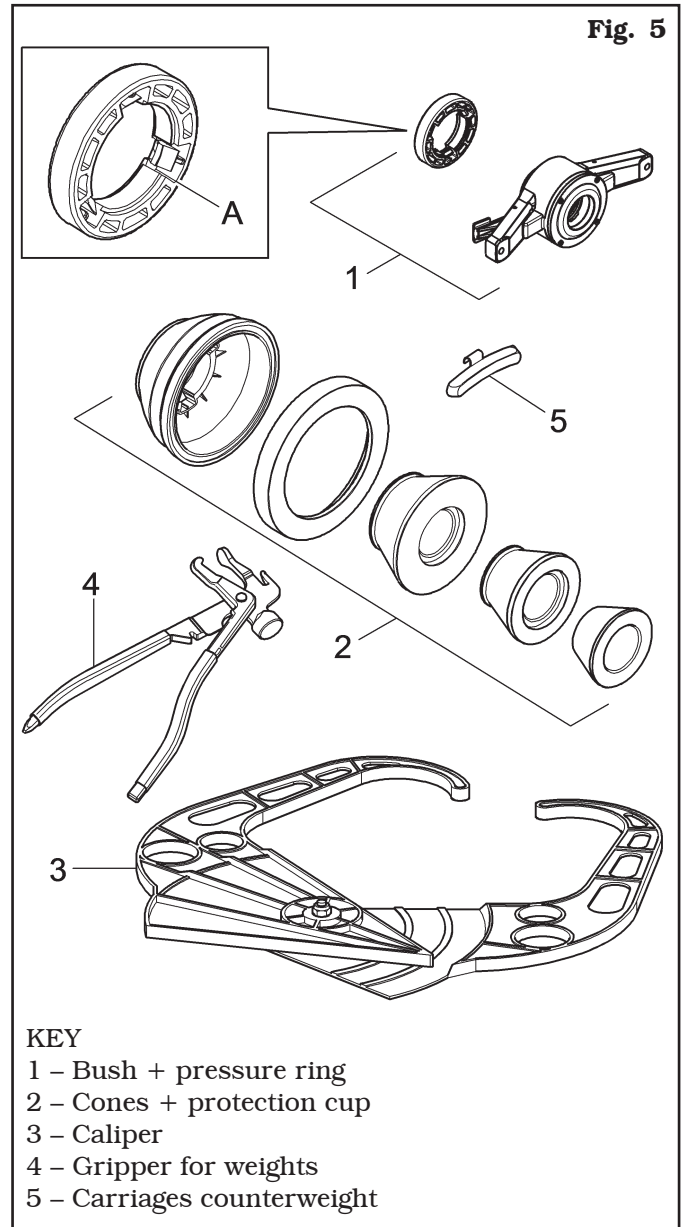

KEY

- 1 - Bush + pressure ring
- 2 - Cones + protection cup
- 3 - Caliper
- 4 - Gripper for weights
- 5 - Carriages counterweight



THE PRESSURE RING (FIG. 5 REF. A) MUST BE MOUNTED WITH THE TEETH OR DISCHARGE SIDE TOWARDS THE RING-NUT (SEE FIG. 5).

9.3 Assembly procedures

9.3.1 Fitting the shaft on the flange

Screw the shaft with an Allen wrench (Fig. 6 ref. 1) on the flange (Fig. 6 ref. 2).

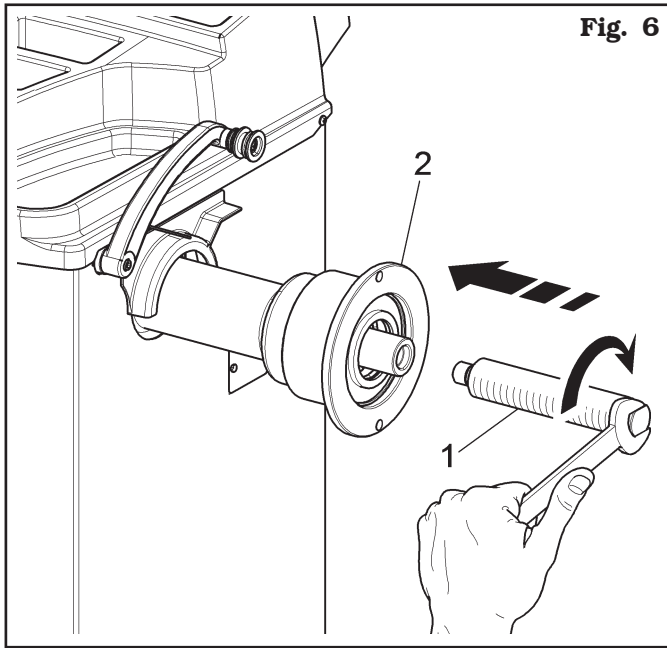

Fig. 6

9.3.2 Fitting the protection guard (without width measuring device)

1. Screw the 3 screws (Fig. 7 ref. 1) and the washers (Fig. 7 ref. 2) to the guard support (Fig. 7 ref. 3) in the special inserts positioned in the rear side of the frame, by means of an Allen wrench.
2. Fit the microswitch (Fig. 7 ref. 4) to the plate (Fig. 7 ref. 5) using screws (Fig. 7 ref. 6), washers (Fig. 7 ref. 7) and nuts (Fig. 7 ref. 8).
3. Fix the plate complete with microswitch (Fig. 7 ref. 3) using screws (Fig. 7 ref. 9), washers (Fig. 7 ref. 10) and nuts (Fig. 7 ref. 11).



PAY ATTENTION: MICROSWITCH LEVER (FIG. 7 REF. 4) MUST BE ADJUSTED BY SCREWDRIVER.

4. Mount the protection guard (Fig. 7 ref. 12) to the support (Fig. 7 ref. 3) interposing the washers (Fig. 7 ref. 13 and 14) and block it through the seeger (Fig. 7 ref. 15).
5. Fit the spring (Fig. 7 ref. 16) between the base of the support and the anchor pin.
6. Connect the 2 wires (Fig. 7 ref. 17) from inside the frame to the normally open (NO) microswitch contacts (Fig. 7 ref. 4).

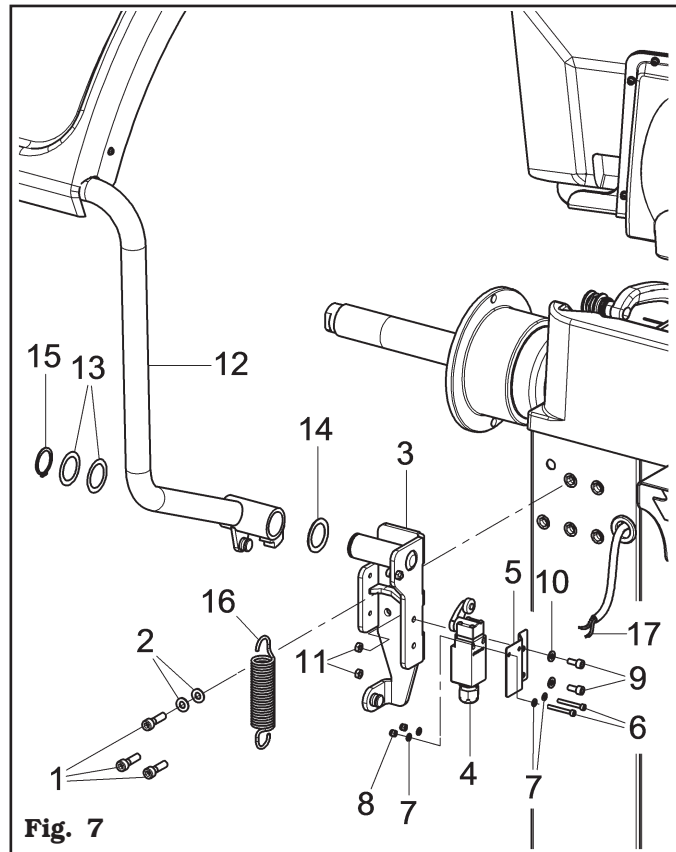
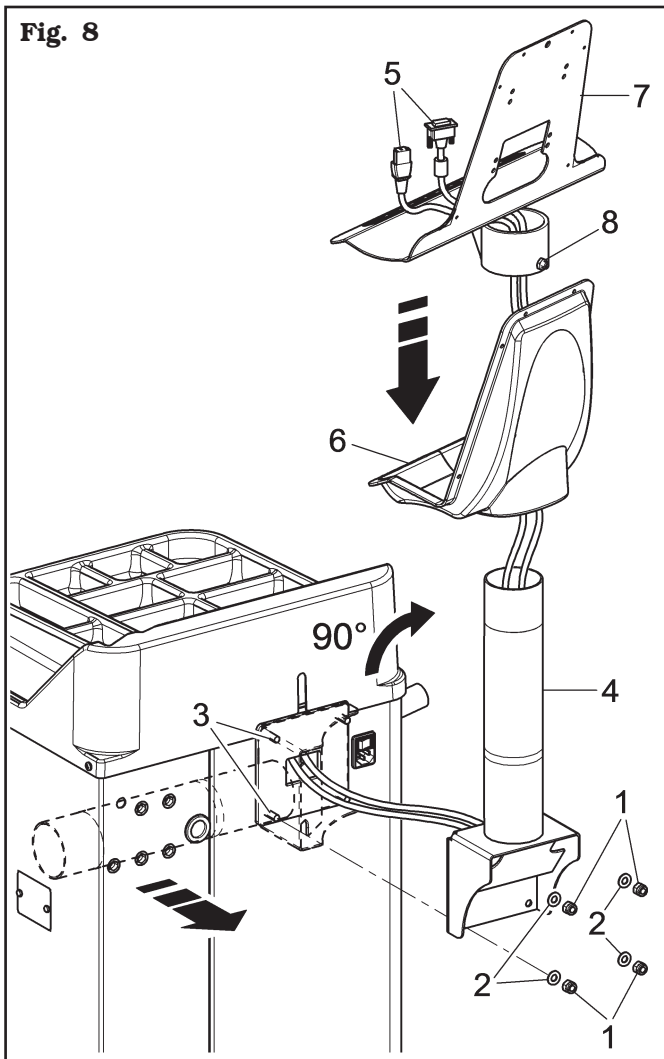

Fig. 7

9.3.3 Monitor fitting

1. Unscrew the nuts (**Fig.8 ref. 1**) and the washers (**Fig. 8 ref. 2**) from the screws (**Fig. 8 ref. 3**). Fit the support tube (**Fig. 8 ref. 4**), turned by 90°, and pay attention to the monitor and keyboard cables (**Fig. 8 ref. 5**) inside it. Insert the guard monitor (**Fig. 8 ref. 6**) into the monitor support (**Fig. 8 ref. 7**) and lock it through the nut (**Fig. 8 ref. 8**). Then screw the previously unscrewed nuts and washers again.



2. Connect the plugs on the power supply sockets and monitor signal. Connect the wiring of the keyboard.

3. Fix the monitor (**Fig. 9 ref. 1**) to the support (**Fig. 9 ref. 2**) with the screws (**Fig. 9 ref. 3**) and the washers (**Fig. 9 ref. 4**) supplied.

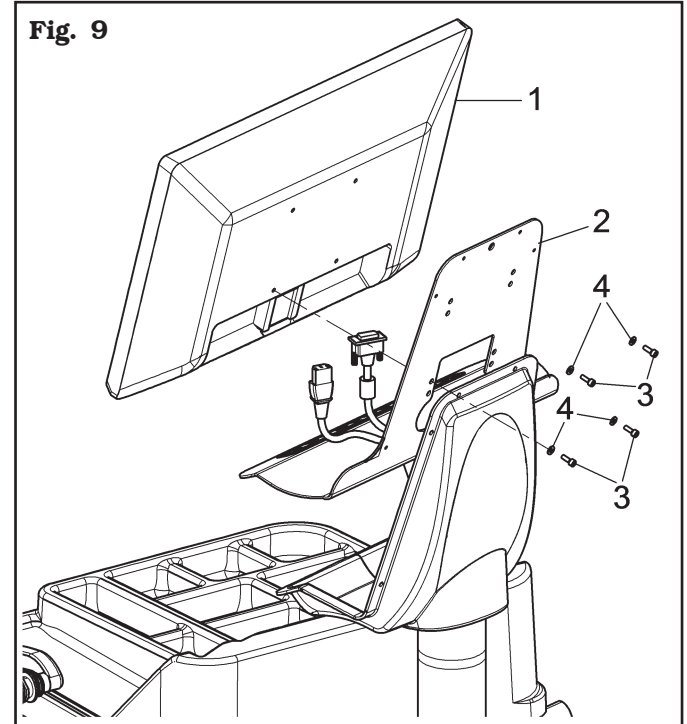

4. Mount the guard (**Fig. 10 ref. 1**) to the support (**Fig. 10 ref. 2**) with the 6 screws (**Fig. 10 ref. 3**) and the washers (**Fig. 10 ref. 4**) supplied.

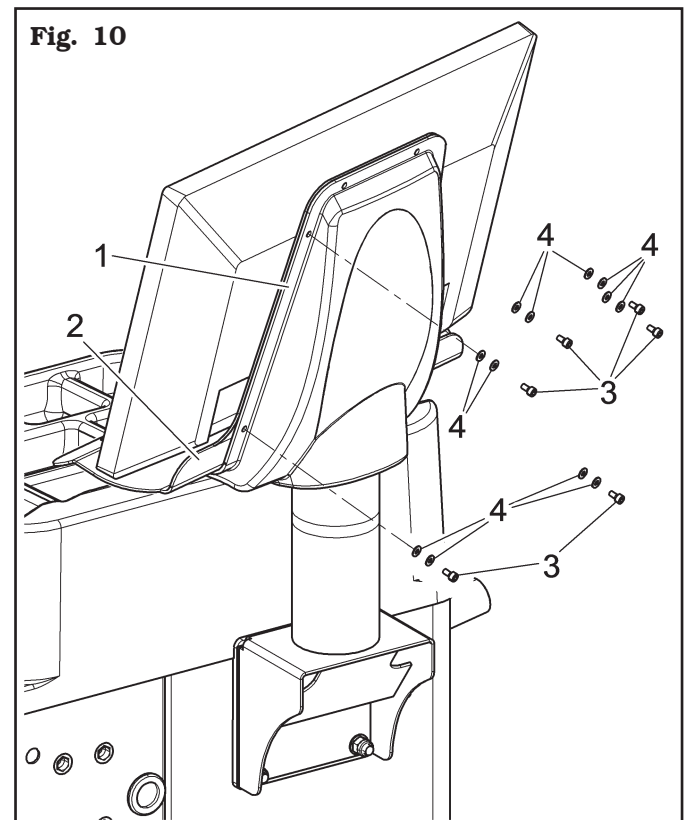

9.3.4 Fitting of external data gauge (optional)

1. Remove the protection guard (**Fig. 11 ref. 12**), if already present.
2. Unscrew the screws (**Fig. 11 ref. 10**) and the washers (**Fig. 11 ref. 11**) from the wheel cover support, being very careful about holding the same support. Insert the gauge bracket (**Fig. 11 ref. 2**) into the lateral slot of the wheel cover support (see **Fig. 13 ref. A**).
3. If necessary, remove the microswitch (**Fig. 11 ref. 13**) so that it is possible to reach the fixing screws more easily.
4. Fit the fixing screw (**Fig. 11 ref. 1**) and screws (**Fig. 11 ref. 10**), previously unscrewed, into the gauge bracket (**Fig. 11 ref. 2**) then screw the assembly to the threaded rivets placed on the rear part of the frame, without using the previously unscrewed washers (**Fig. 11 ref. 11**). Fix bracket (**Fig. 11 ref. 4**) to the support guard (**Fig. 11 ref. 14**) with the screws (**Fig. 11 ref. 8**) and the washers (**Fig. 11 ref. 9**). Lock the gauge arm (**Fig. 11 ref. 3**) to the brackets (**Fig. 11 ref. 2-4**) using the 2 screws (**Fig. 11 ref. 5**), the washers (**Fig. 11 ref. 6**) and the nuts (**Fig. 11 ref. 7**), so that the shaft and the gauge arm are levelled (see **Fig. 12**).

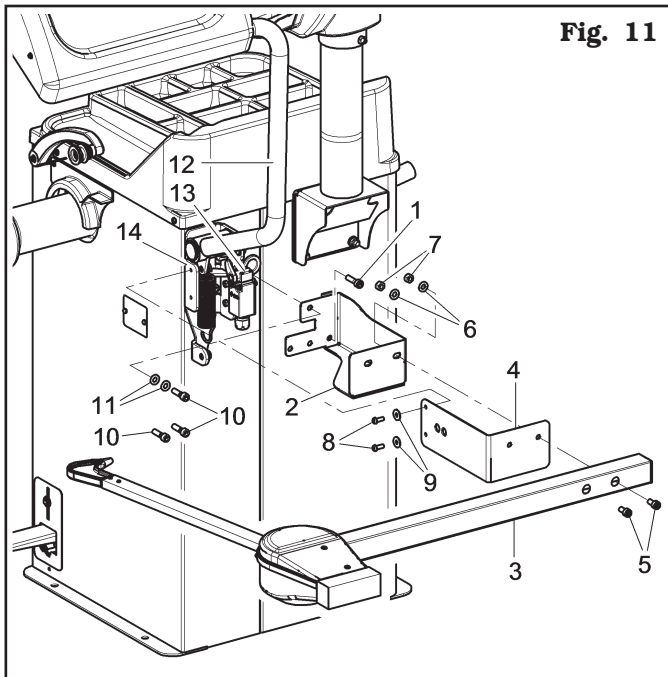

Fig. 11

5. Also make sure the gauge tip (**Fig. 12 ref. 1**) is positioned APPROXIMATELY at the centre of the chuck.

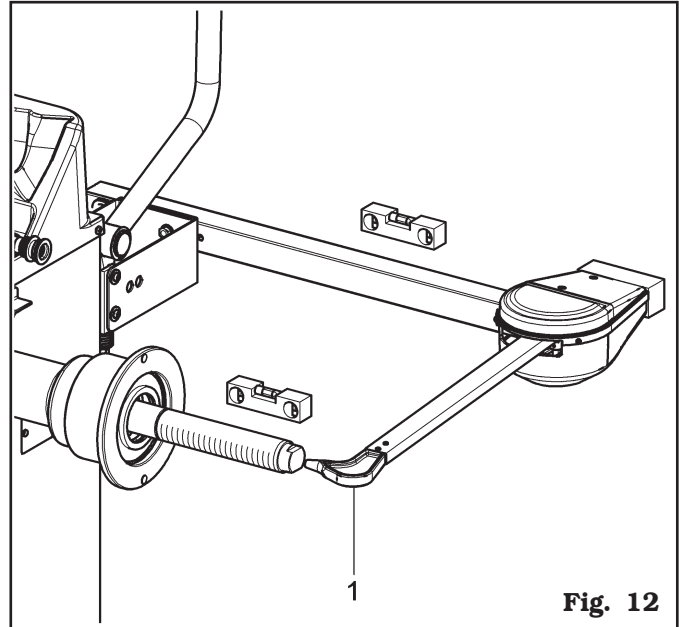

Fig. 12

6. Connect connector (**Fig. 13 ref. 1**) of the cable coming from inside the machine to connector (**Fig. 13 ref. 2**) of the cable coming from the gauge arm. Fit the section of the cable with the connectors inside the arm (**Fig. 13 ref. 3**).
7. Fasten the cable with clamps.
8. Enable the external data gauge and carry out the device's calibration.

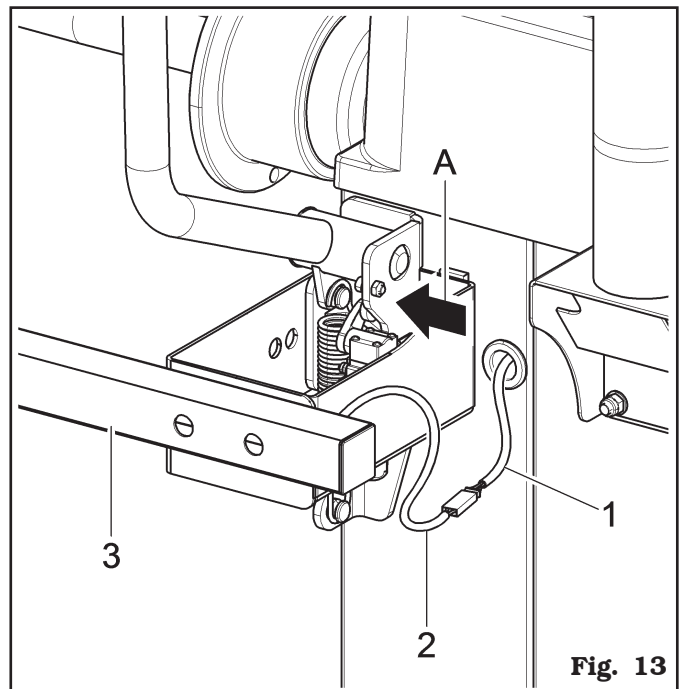

Fig. 13

9. Remount microswitch (**Fig. 11 ref. 13**), if previously removed.
10. Fit the protection guard (**Fig. 11 ref. 12**), as described in Par. 9.3.2..

10.0 ELECTRICAL CONNECTIONS



EVEN THE TINIEST PROCEDURE OF AN ELECTRICAL NATURE MUST BE CARRIED OUT BY PROFESSIONALLY QUALIFIED STAFF.



BEFORE CONNECTING THE MACHINE MAKE SURE THAT:

- THE MAIN POWER RATING CORRESPONDS TO THE MACHINE RATING AS SHOWN ON THE MACHINE PLATE;
- ALL MAIN POWER COMPONENTS ARE IN GOOD CONDITION;
- THE ELECTRICAL SYSTEM IS PROPERLY GROUNDED (GROUND WIRE MUST BE THE SAME CROSS-SECTION AREA AS THE LARGEST POWER SUPPLY CABLES OR GREATER);
- MAKE SURE THAT THE ELECTRICAL SYSTEM FEATURES A CUTOUT WITH DIFFERENTIAL PROTECTION SET AT 30 mA.

Connect the machine up to the mains by means of the 3-pole plug provided (110V - 230 V 1-phase) through the wall socket.

If the plug provided is not suitable for the wall socket, fit a plug that complies with local and applicable regulations. This operation must be performed by expert and professional personnel.



FIT A TYPE-APPROVED (AS REPORTED BEFORE) PLUG TO THE MACHINE CABLE (THE GROUND WIRE IS YELLOW/GREEN AND MUST NEVER BE CONNECTED TO ONE OF THE TWO PHASE LEADS).



MAKE SURE THAT THE ELECTRICAL SYSTEM IS COMPATIBLE WITH THE RATED POWER ABSORPTION SPECIFIED IN THIS MANUAL AND APT TO ENSURE THAT VOLTAGE DROP UNDER FULL LOAD WILL NOT EXCEED 4% OF RATED VOLTAGE (10% UPON START-UP).



FAILURE TO OBSERVE THE ABOVE INSTRUCTIONS WILL IMMEDIATELY INVALIDATE THE WARRANTY.

10.1 Electrical checks



BEFORE STARTING UP THE WHEEL-BALANCER, BE SURE TO BECOME FAMILIAR WITH THE LOCATION AND OPERATION OF ALL CONTROLS AND CHECK THEIR PROPER OPERATION (SEE PAR. "CONTROLS").



CARRY OUT A DAILY CHECK OF MAINTAINED-TYPE CONTROLS CORRECT FUNCTIONING, BEFORE STARTING MACHINE OPERATION.

Once the plug/socket connection has been made, turn on the machine using the master switch (Fig. 14 ref. 1).

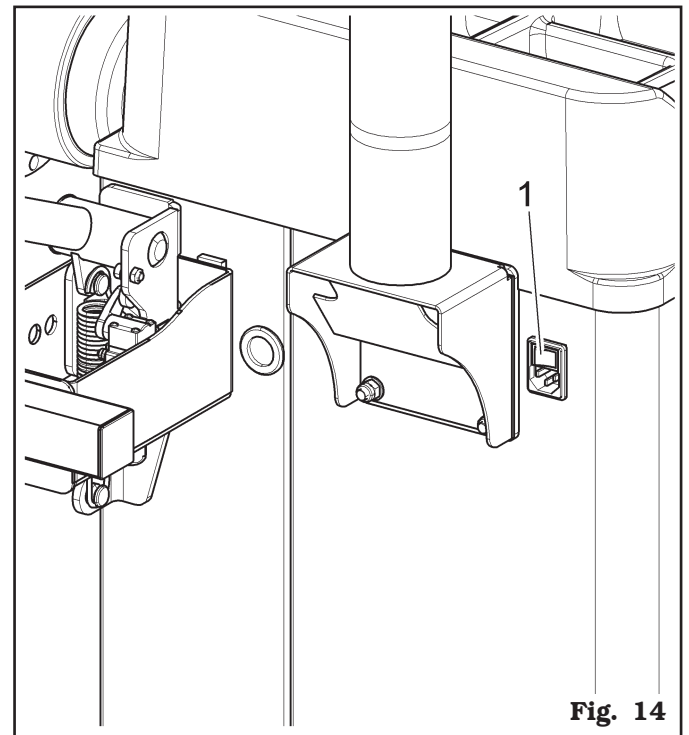

Fig. 14

11.0 FITTING THE WHEEL ON THE SHAFT



To achieve perfect balancing, the wheel must be carefully and properly fitted on the shaft.
Imperfect centring will inevitably cause unbalances.



WHAT IS MOST IMPORTANT IS THAT ORIGINAL CONES AND ACCESSORIES, SPECIALLY DESIGNED TO BE EMPLOYED WITH THE WHEEL BALANCERS, ARE USED.

Wheel fitting using the cones provided is illustrated below.

For alternative fittings, using optional accessories, refer to the special instructions provided separately.

11.1 Wheel assembly

1. Remove any type of foreign body from the wheel (**Fig. 15 ref. 3**): already-existing weights, stones and mud, and make sure the shaft (**Fig. 15 ref. 1**) and the rim centring area are clean before fitting the wheel on the shaft.
2. Carefully choose the cone (**Fig. 15 ref. 2**) most suitable for the wheel to be balanced. These accessories must be selected according to the shape of the rim. Carefully position the wheel (**Fig. 15 ref. 3**), fitting the cone (**Fig. 15 ref. 2**) on the shaft (**Fig. 15 ref. 1**) (otherwise this could seize) until this rests against the support flange (**Fig. 15 ref. 4**).
3. Fit the wheel with the inner side of the rim towards the wheel balancer and against the cone.

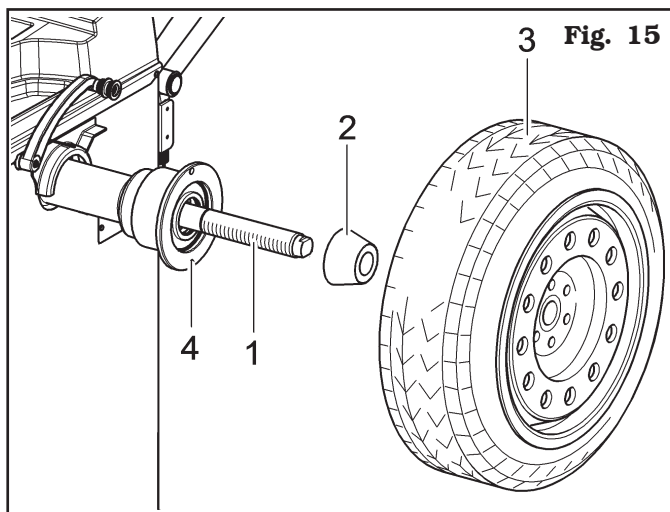

4. Fit the protection cap (**Fig. 16 ref. 1**) in the locknut (**Fig. 16 ref. 2**) and fasten against the wheel.

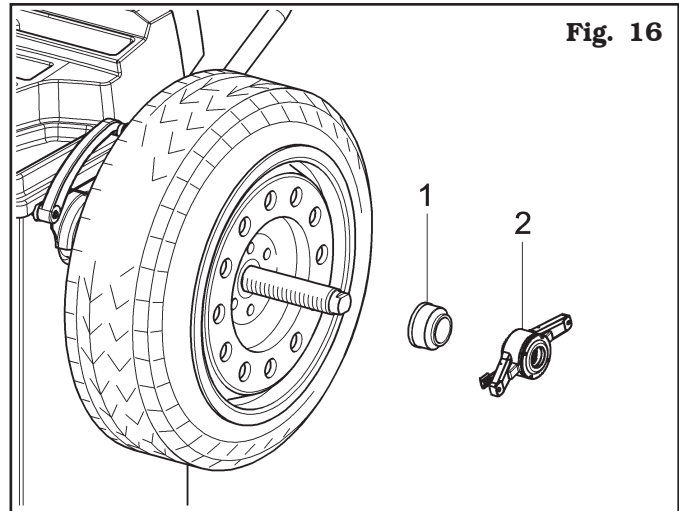

Some aluminium wheels, with very high centring, must be fitted with the cone outside the wheel.

5. Clean the shaft (**Fig. 17 ref. 1**) before fitting the wheel.
6. Fit the wheel (**Fig. 17 ref. 3**) with the inside of the rim towards the wheel balancer, until the wheel is up against the support flange (**Fig. 17 ref. 2**).

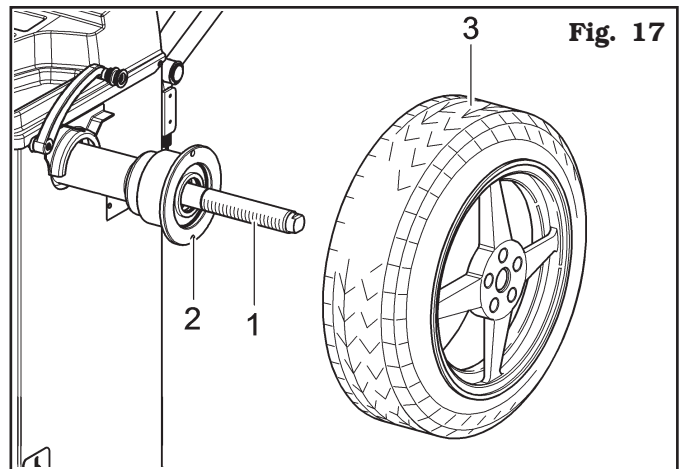

7. Fit the cone (**Fig. 18 ref. 3**) with the narrowest part turned towards the wheel.
8. Fit the pressure ring (**Fig. 18 ref. 1**) in the nut (**Fig. 18 ref. 2**) and fasten the cone (**Fig. 18 ref. 3**).

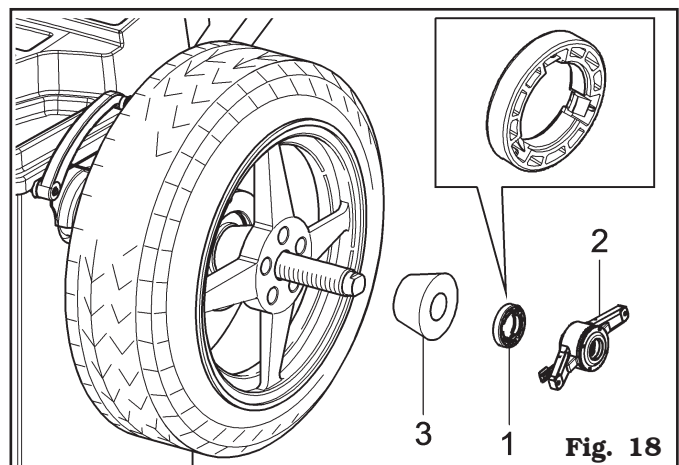



THE PRESSURE RING (FIG. 18 REF. 1) MUST BE MOUNTED WITH THE TEETH SIDE TOWARDS THE RING NUT (FIG. 18 REF. 2).

12.0 CONTROL PANEL

The wheel balancers are equipped with a control panel equipped with a keyboard to interact/operate the controls presented in graphical form on the monitor. On the monitor are displayed all the instructions for the correct wheel balancing, for example indicating where the operator shall fit adhesive or clip weights and the balancing mode and/or option used, as well as correct wheel rotation for inner/outer weights positioning.

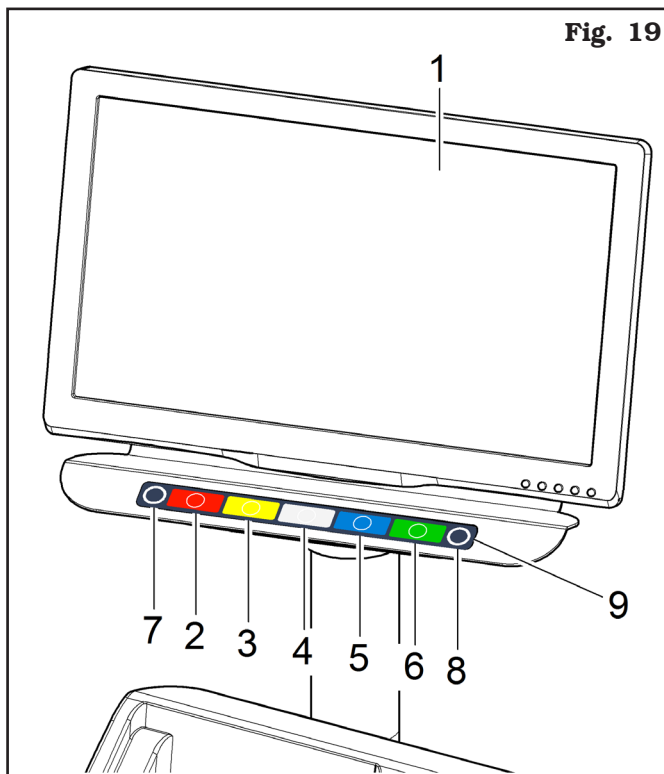

Fig. 19

KEY

- 1 – Monitor
- 2 – Function push button (red)
- 3 – Function push button (yellow)
- 4 – Function push button (grey)
- 5 – Function push button (blue)
- 6 – Function push button (green)
- 7 – Previous page push button
- 8 – Next page/print push button
- 9 – Push button panel (keyboard with 7 keys)

13.0 WHEEL BALANCING

13.1 *Switching the machine on and off*

Press the "ON" switch (**Fig. 14 ref. 1**), located in the rear part of the equipment.

Wait a few seconds until the complete loading of the operational program. The equipment is ready to operate when the main screen "Home" appears on the monitor.

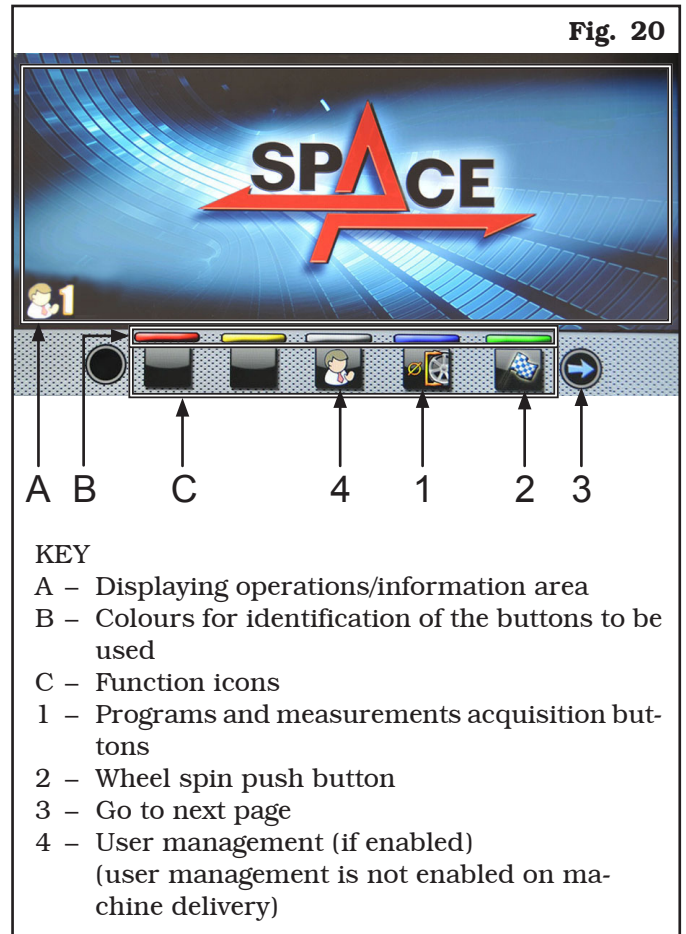

Fig. 20

KEY

- A – Displaying operations/information area
- B – Colours for identification of the buttons to be used
- C – Function icons
- 1 – Programs and measurements acquisition buttons
- 2 – Wheel spin push button
- 3 – Go to next page
- 4 – User management (if enabled)
(user management is not enabled on machine delivery)

At the bottom of the main screen page and of each screen page described below, there will be coloured rectangles (**Fig. 20 ref. B**) located above function identification icons (**Fig. 20 ref. C**). These functions are activated by pressing the appropriate coloured button on the push-button panel (**Fig. 19 ref. 9**). Press the button (**Fig. 20 ref. 3**) to display a second page where you can access the "Technical assistance" menu and the "Run-out" menu (see **Fig. 21**).

Fig. 21

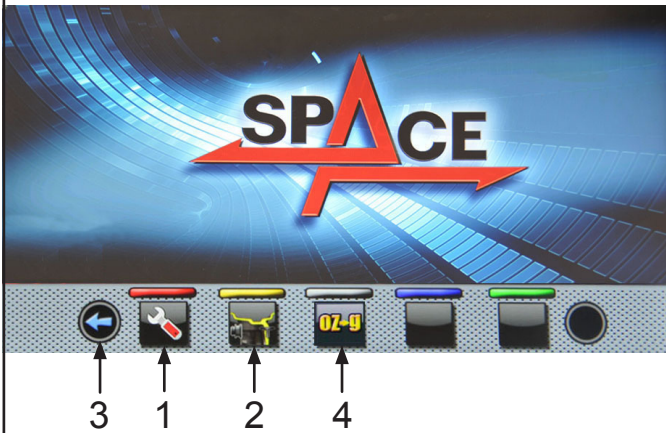

KEY

- 1 – User menu
- 2 – Run-out menu (visible only if the machine is fit or if the Run-out device is enabled)
- 3 – Return to previous page
- 4 – Measurement unit setting.

The machine is supplied with “grams” option





enabled (see Chap. 14.0), so weights will be displayed only in grams and no icons will be displayed onto push button 4.

In order to modify the measurement unit carry out the following procedure: if “ounce” option



is activated from user menu (see Chap. 14.0), “ounce” weight displaying mode is set,

and push button  will be displayed.

Press the button  to set machine weight display in grams and on the screen will be

displayed icon .

Press the button  to set machine weight display in ounces and on the screen will be

displayed icon .

In order to turn off the machine, simply press the "OFF" switch (**Fig. 14 ref. 1**).



WHEN THE EQUIPMENT IS TURNED OFF LOSES ALL THE MEASUREMENTS AND THE STORED DATA (SIZE, SPINS, USERS, ETC ...). AT RESTARTING,



PRESSING THE BUTTON (IN THE CASE HAVE NOT YET BEEN STORED ON THE NEW MEASURES AFTER THE SWITCHING ON), THE MACHINE DOES NOT PERFORM ANY OPERATION.

13.2 Balancing programs setting

The setting of the balancing programs can be performed in two ways:

- through the gauge arm (rapid setting);
- through “Measurement being acquired” screen, ap-



pearing when the button is pressed (**Fig. 20 ref. 1**).

The setting modes are completely different even if they allow to reach the same result (but with different times).

13.2.1 Programs rapid setting and measurements through distance-diameter caliper arm

The use of the distance-diameter caliper arm allows the rapid automatic wheel balancing program and the measures entry. From page "Home":

- bring into contact the weights fitting gripper with the inner part of the rim (1 contact only) to select "STATIC" program (see Fig. 22).



Fig. 22



REPEATEDLY BRINGING THE GAUGE'S ARM (FIG. 23 REF. 1) IN CONTACT WITH THE CHUCK (FIG. 23 REF. 2), THE PROGRAM WILL CYCLE FROM "STATIC" TO "STATIC 1" TO "STATIC 2" THEN RETURNING TO THE BEGINNING.

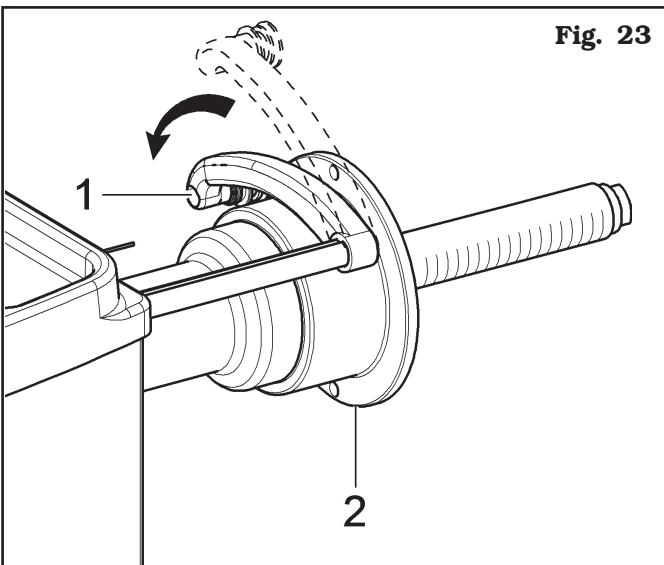

Fig. 23

- bring into contact the weights fitting gripper with the inner part of the rim (2 contact points) (see Fig. 22) to select "ALU-S" program.



REPEATEDLY BRINGING THE GAUGE'S ARM (FIG. 23 REF. 1) IN CONTACT WITH THE CHUCK (FIG. 23 REF. 2), THE PROGRAM WILL CYCLE FROM "ALU-S" TO "ALU-S1" TO "ALU-S2" THEN RETURNING TO THE BEGINNING.



WHENEVER THE EXTERNAL DATA GAUGE (SEE FIG. 24) (OPTIONAL) IS KEPT IN POSITION FOR A FEW SECONDS AGAINST THE RIM (UNTIL THE MACHINE MAKES AN APPROPRIATE SOUND NOTIFICATION), THE POSITION IS STORED AND THE VALUES MEASURED IN THE PRE-ARRANGED FIELDS IN THE SELECTED WHEEL BALANCING PROGRAM ARE LOADED.

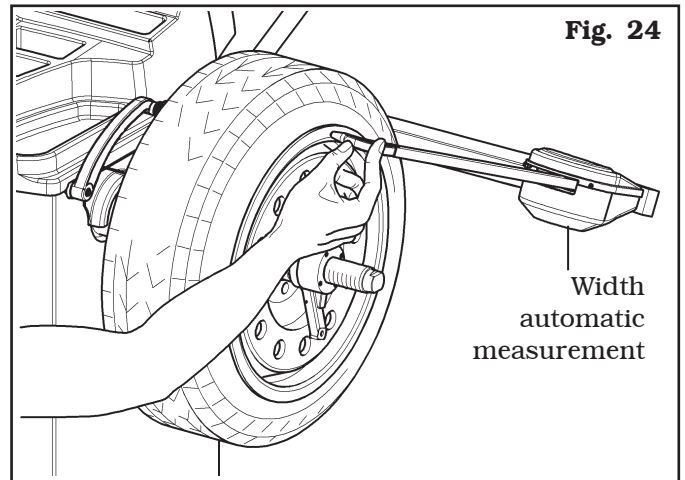



Fig. 24

- After entering all the required measures, you can spin the wheel by pressing the button  and closing the protective guard.

• **Measuring procedure of electronic RUN-OUT with the distance-diameter caliper arm.**

The electronic RUN-OUT measuring device is useful to check if the rim has some imperfections.

To access the screen to choose the rim control mode, proceed as follows:

- from the "Home" page, press the button



(Fig. 25 re. 1) and then the button  (see Fig. 26 ref. 1).

Fig. 25



- The following screen page will appear on the monitor:

Fig. 27

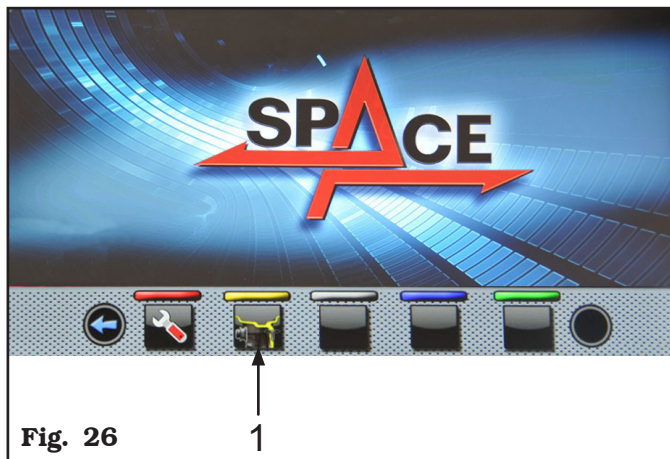
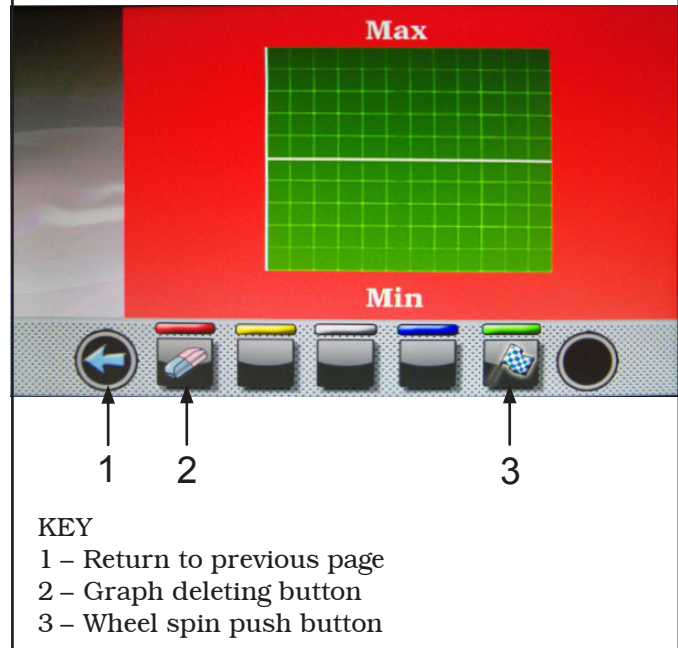

KEY

- 1 - Return to previous page
- 2 - Graph deleting button
- 3 - Wheel spin push button

Place the distance-diameter caliper grippers (Fig. 28 ref. 1) on the inner side of the rim, as shown in Fig. 28.



Press the green button on the monitor (Fig. 27 ref. 3) to start the rim analysis procedure. The circle starts to spin at low speed (30 rpm) and at the end of the measurement the roundness graph appears, as shown in the Fig. 29.

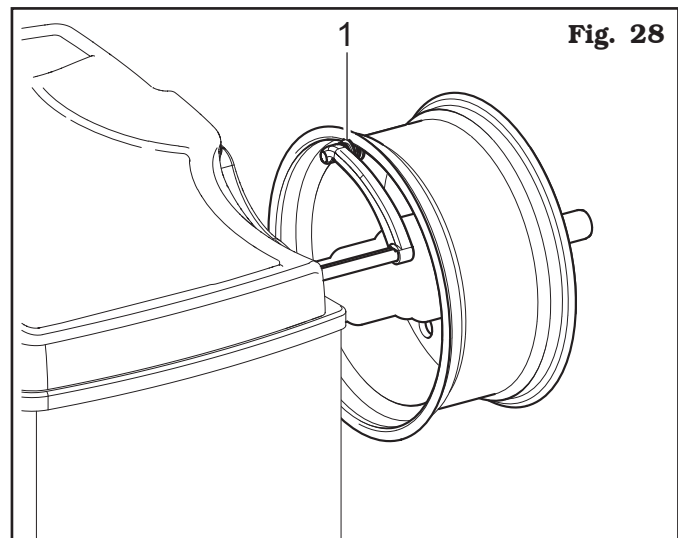

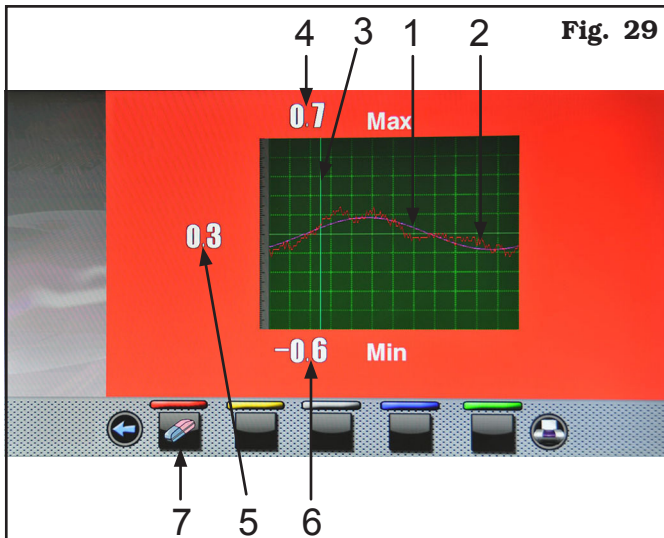

KEY

- 1 - Fundamental sine wave (fuchsia-coloured-graph)
- 2 - Graph of detected roundness (red)
- 3 - Slider that indicates the current position of the rim ("12 o'clock") (green)
- 4 - Value in mm of the highest peak of imperfection detected on the rim
- 5 - Value in mm of imperfection of the rim at the current position
- 6 - Value in mm of the lowest peak of imperfection detected on the rim
- 7 - Graph deleting button

The red graph (**Fig. 29 ref. 2**) represents exactly the geometric shape of the rim. The more the circle is round and linear, the more the graph is flat, unlike the more the circle has deficiencies, the more the graph is large.

You can follow the eccentricity in the graph by manually turning the rim, the green-coloured-slider (**Fig. 29 ref. 3**), indicates the position of the rim in "12 o'clock" position.

13.2.2 Programs setting through "Measurements acquisition" screen page

From the "Home" page, press the  (**Fig. 20 ref. 1**) button to display "Measurements acquisition" screen page below:







PRESS THE BUTTON  (**Fig. 20 ref. 1**) **TO DISABLE THE AUTOMATIC FUNCTIONS FOR THE SELECTION OF THE BALANCING PROGRAM OF DISTANCE-DIAMETER CALIPER ARM, DESCRIBED IN PAR. 13.2.1. TO BE ABLE TO REUSE THE AUTOMATIC FUNCTION TO SELECT THE WHEEL BALANCING PROGRAM WITH GAUGE ARM, IT IS NECESSARY TO RETURN TO "HOME" PAGE, BY PRESSING THE**





BUTTON

The selection of the wheel balancing program is possible in 2 ways:

- with highlighted program (blue colour) by pressing the  or  until you see the desired program. With this mode only the 11 standard programs can be selected (DYN, ALU-S, ALU-S1, ALU-S2, STAT, STAT-1, STAT-2, ALU-1, ALU-2, ALU-3, ALU-4).



 **IF THE PROGRAM NAME IS NOT HIGHLIGHTED (BLUE), PRESS**



THE BUTTON  **REPEATEDLY UNTIL THE ABOVE CONDITION IS REACHED.**

- Press the button  to display the following programs selection screen page:



Use the arrows  and/or  to select the wished mode (blue). In this mode you can select the 11 standard programs (listed above) and special programs (PAX360, PAX420, PAX460, PAX700).



AFTER YOU HAVE SELECTED THE DESIRED PROGRAM, USE THE EXTERNAL DATA GAUGE (IF ANY) TO DETECT THE MEASURES REQUIRED BY THE PROGRAM.



WHENEVER THE EXTERNAL DATA GAUGE (SEE FIG. 24) (IF ANY) IS KEPT IN POSITION AGAINST THE RIM (UNTIL THE MACHINE MAKES AN APPROPRIATE SOUND NOTIFICATION), THE POSITION IS STORED AND THE VALUES MEASURED IN THE PRE-ARRANGED FIELDS IN THE SELECTED WHEEL BALANCING PROGRAM ARE LOADED.

- After entering all the required measures, you can spin



the wheel by pressing the button  and closing the protective guard.

13.3 Indicative display of points where to detect measures/to fit weight



IT IS VERY IMPORTANT TO REMEMBER THE POINTS SELECTED FOR MEASUREMENT INSIDE THE RIM SINCE DURING THE WEIGHTS FITTING WITH FIXED LASER YOU WILL NOT HAVE ANY OTHER REFERENCE EXCEPT FOR THE CROSS LINE ON THE RIM, GENERATED BY THE LASER ITSELF. THE POSITIONING IN DEPTH WILL BE AT THE DISCRETION OF THE OPERATOR.

Depending on the type of program selected, the machine shows on the monitor the guideline points where to take measures and, consequently, where you must apply weights (**Fig. 30 ref. 4-5**).

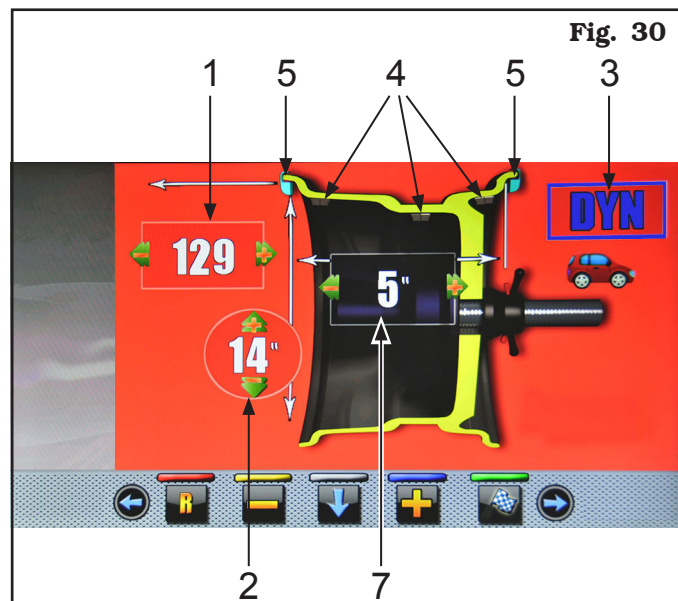

KEY

- 1 - 1st weight fitting point distance
- 2 - Rim diameter
- 3 - Balancing mode
- 4 - Point at which to take the measure/adhesive weight fitting
- 5 - Point at which to take the measure/clip weight fitting
- 6 - Rim width



THE MORE THE POINTS CHOSEN FOR THE PROBING ARE DISTANT FROM EACH OTHER THE MORE THE BALANCING WILL BE EFFECTIVE.

13.3.1 Weights positioning

The monitor displays when it is absolutely necessary that the weight is applied at "12 o'clock" position. Pay particular attention to the content of the weights identification icons since if the following words **H 12** are displayed, then the icon corresponding weight has to be applied at "12 o'clock" position (typical of ALU-S1, ALU-S2 programs).



IF ALL MEASURES REQUIRED BY THE PROGRAM HAVE NOT BEEN TAKEN/INSERTED, THE MACHINE DOES NOT ALLOW THE WHEEL SPIN TO DETECT THE UNBALANCE.

13.4 Displaying the active/modifiable field

During the various phases of measures detection, the active field turns blue.

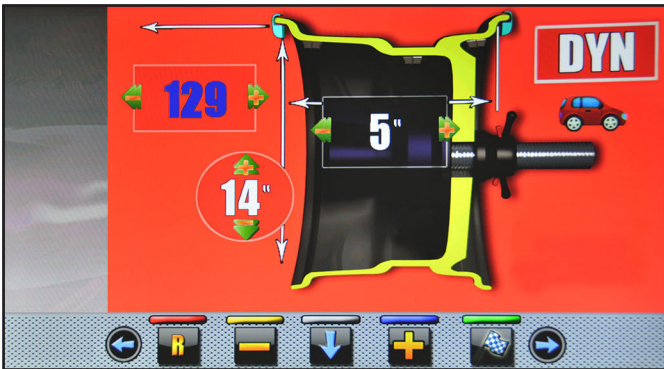

Pressing the buttons **+** or **-** you can change the value and/or program inside the active field. To change the selected active field, simply press the button



until the desired field is coloured blue.



THE SELECTION OF THE ACTIVE FIELD IS DONE BY HIGHLIGHTING THE FIELDS IN A CLOCKWISE DIRECTION.

NORMALLY DURING THE DETECTION OF MEASUREMENTS, THE 1ST ACTIVE FIELD WILL BE THE ONE FOR THE SELECTION OF THE PROGRAM.



THERE IS A CASE, HOWEVER, IN WHICH THE 1ST ACTIVE FIELD WILL BE THE RIM WIDTH.

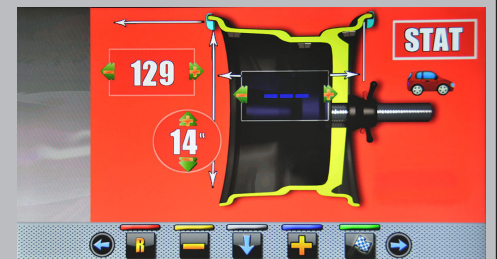

THIS CASE WILL OCCUR ONLY IF FROM "HOME" PAGE IS DETECTED ONLY ONE MEASUREMENT INSIDE THE RIM. THE PROGRAM WILL AUTOMATICALLY SET TO "STATIC" BUT IT WILL MAKE IT POSSIBLE (IN CASE OF ABSENCE OF EXTERNAL DATA GAUGE) TO MANUALLY ENTER RIM WIDTH AND TO QUICKLY SWITCH TO THE PROGRAM "DYNAMIC".



13.5 Wheel balancing screen page description

After executing the spin of the wheel, the monitor displays a series of important information that helps the operator in his operations and subsequent choices.

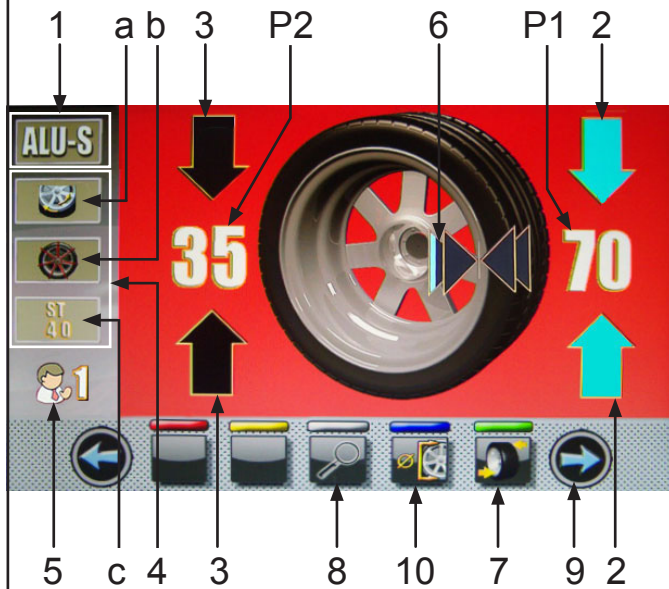
Fig. 31



KEY

- 1 – Balancing mode
- P1 – Weight to be fitted on rim outer side
- P2 – Weight to be fitted on rim inner side
- 2 – Wheel placed to fit the weight on wheel outer side (arrows both green)
- 3 – Wheel not placed to fit the weight on wheel inner side (blue/black arrows)
- 4 – Wheel balancing suggestions
- 4a – MATCHING program
- 4b – SPOKES program (adhesive weights program) or SPLIT program (clip weights program)
- 4c – STATIC Program
- 5 – N° user (if selected)
- 6 – Arrows indicating the weight fitting point with distance-diameter caliper arm
- 7 – Wheel repositioning button for weights fitting
- 8 – Display of the weight with the maximum resolution of 1 g / 0,05 oz
- 8a – Display of the weights in grams 
- 8b – Display of the weights in ounces/grams 
- 9 – By pressing the button  you will see the following page where you can select one of the programs suggested by the machine.
- 10 – Programs and measurements acquisition buttons

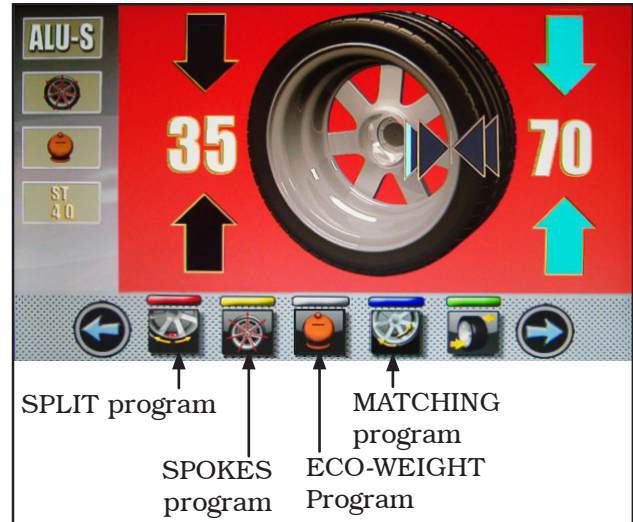

IF THE GUARD AND REPOSITIONING FUNCTION ARE DISABLED, ON THE BUTTON IN POS. 7 FIG. 31, YOU WILL SEE THE



ICON THAT WILL ALLOW THE WHEEL SPIN WITHOUT RETURNING TO THE PREVIOUS PAGE. THE POSITIONING OF THE WHEEL FOR THE APPLICATION OF THE WEIGHTS MUST BE DONE MANUALLY.

8a-Display of the weights in GRAMS

Set the unit of measurement for weights

display to GRAMS  (see Par. 14.1 "Options menu").

On the following screen page:



press the button  to display the weight with maximum resolution (1g) to be fitted on the wheel, expressed in grams.

The following screen will appear on the monitor:



Press again the button  to display the approximated weight to be fitted to the wheel, expressed in grams.



**7b-Display of the weights in OUNCES/GRAMS
Set the unit of measurement for weights**

display to OUNCES/GRAMS  (see Par. 14.1 "Options menu").

On the following screen page:



press the button  to display the weight with maximum resolution (0.05 oz) to be fitted on the wheel, expressed in ounces.

The following screen will appear on the monitor:



Press the button  to set the display of the weights to be fitted on the wheel in grams. The following screen will appear on the monitor:



Press the button  to display the weight with maximum resolution (1g) to be fitted on the wheel, expressed in grams. The following screen will appear on the monitor:



Press the button  to set the display of the weights to be fitted again in ounces. The following screen will appear on the monitor:



13.5.1 Balancing mode

The machine has the ability to perform the wheel balancing (weights fitting) in 2 different ways:

- using the distance-diameter caliper arm with weights fitting grippers;
- weights fitting at "6 o'clock" (without the use of lasers).

• **Weights fitting with distance-diameter caliper arm.**

1. Place the adhesive weight on the arm grippers.

Fit the adhesive weight
in the pliers of the gauge rod



2. Pull out the gauge until the arrows (**Fig. 31 ref. 6**) both turn green.
3. Rotate the gauge arm until the weight touches the rim.

Fit weight on the position
where pliers touches the wheel



4. Bring the distance-diameter caliper arm into resting position.



5. Press the  button to change the weight fitting side.

6. Proceed in the same way as described in points 1-2-3.



BEFORE REMOVING THE DIAMETER-DISTANCE CALIPER, PRESS THE BRAKE PEDAL AND HOLD IT DOWN UNTIL THE WEIGHT HAS NOT BEEN APPLIED, ENSURING IN THIS WAY THAT, DURING THESE PHASES, THE WHEEL CAN NOT ROTATE.

- **Weights fitting at "6 o'clock" (without the use of lasers).**



TO USE THIS MODE, IT IS NECESSARY THAT THE RELEVANT FUNCTION IS ENABLED



ON THE MENU "OPTIONS" DESCRIBED IN PAR. 14.1.



TO USE THIS WEIGHT APPLICATION MODE THE OPERATOR MUST REMEMBER THE PRECISE POINT WHERE THE MEASUREMENT WAS TAKEN WITH THE DISTANCE-DIAMETER CALIPER ARM.



USING THIS MODE, THE MACHINE ALLOWS YOU TO APPLY ANY ADHESIVE WEIGHTS THAT WOULD BE APPLIED TO "12 HOURS" TO "6 O'CLOCK". IF, AFTER YOU ENABLE THIS MODE, ON BALANCING PROGRAM APPEARED AGAIN THE **H 12 ICON (ONLY IN THIS CASE) THE ADHESIVE WEIGHT WILL BE APPLIED TO "12 HOURS".**

At the end of the spin, the wheel stops in place to apply the weight at "6 o'clock". The positioning of the weight (s) in depth shall be at the discretion of the operator, depending on where remembers taking the measure.



BE SURE TO APPLY THE (INTERNAL OR EXTERNAL) WEIGHT AS INDICATED BY THE 2 GREEN ARROWS (Fig. 31 ref. 2 or 3) ON THE CORRESPONDING MONITOR SCREEN.

13.6 Use of machines with disabled automatic data gauge

The entry of diameter, width and distance measures of the machine rim must be performed manually. The reading of these measures can be made as follows:

- visual readout on caliper graduated scale (distance);
- values readout on rim (diameter and width);
- width value detection with manual caliper (width) (see Fig. 32).

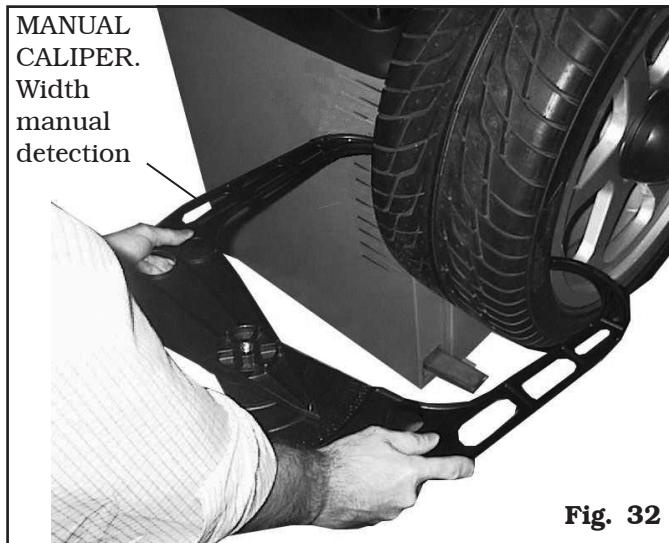



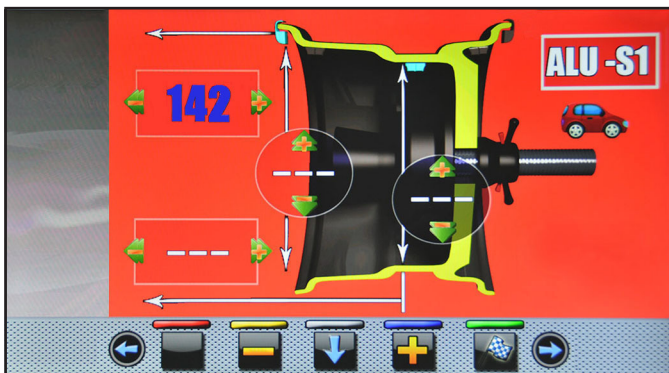

Fig. 32

13.6.1 Manual setting of wheel dimensions

In case the operator wants to edit and/or manually enter the wheel dimensions, proceed as follows:

- from the desired measurement mode screen, press the button  until highlighting with blue the field to modify/edit;
- press the buttons  or  until reaching the desired value;
- press button  to shift to the next value.



After entering all the required measures, you can spin



the wheel by pressing the button  and closing the protective guard.

In case the distance-diameter caliper was disabled, the displayed page for detected unbalance is as follows:

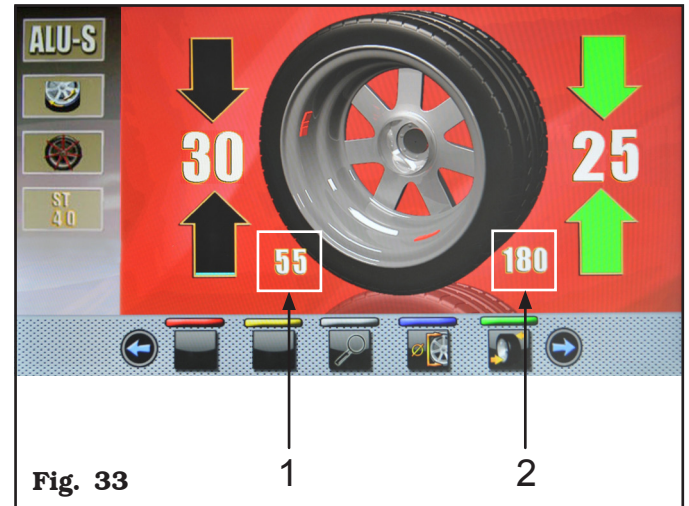

Fig. 33

In this screen page, in addition to the information of the detected unbalance, there are measurements in mm where you must remove the gauge arm (Fig. 33 ref. 1-2) to apply the weights inside the rim.

13.7 Standard balancing programs

13.7.1 Static

The STATIC program permits balancing wheels by fitting adhesive weights on the outer and inner sides of the rim. Enter the measurements (see Par. 13.2.1 or 13.6.1) and proceed as described in Par. 13.5.

At the end of the procedure, the wheel balancing conditions can be checked by performing a trial spin.



The procedure has now been completed.

13.7.2 Static-1

STATIC 1 function is a procedure that offsets wheel vibrations using a single weight with clip on a single plane positioned exactly at "12 o'clock".

Enter the measurements (see Par. 13.2.1 or 13.6.1) and proceed as described in Par. 13.5 "Dynamic balancing" (only for wheel inner side).

At the end of the procedure, the wheel balancing conditions can be checked by performing a trial spin.

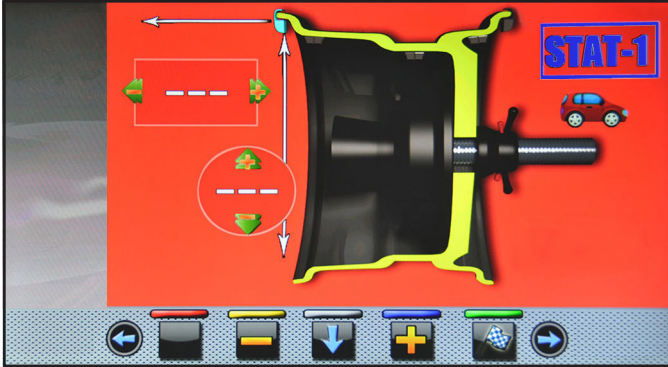

The procedure has now been completed.

13.7.3 Static-2

STATIC 2 function is a procedure that offsets wheel vibrations using a single adhesive weight on a single plane positioned exactly at "12 o'clock".

Enter the measurements (see Par. 13.2.1 or 13.6.1) and proceed as described in Par. 13.5 "Dynamic balancing" (only for wheel inner side).

At the end of the procedure, the wheel balancing conditions can be checked by performing a trial spin.

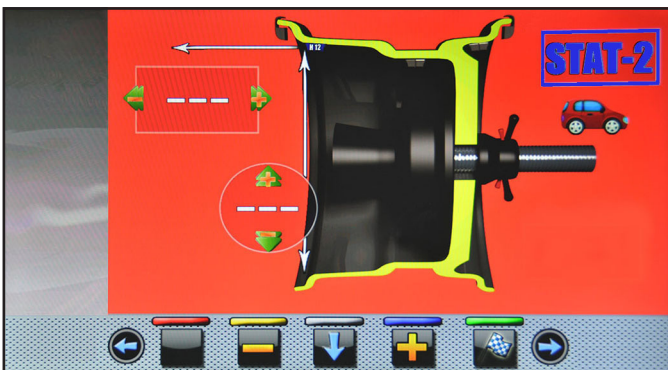

The procedure has now been completed.

13.7.4 Dynamic

The DYNAMIC program allows the wheels balancing by fitting two clip adhesive weights: one on the outside and one on the inside rim. Enter the measurements (see Par. 13.2.1 or 13.6.1) and proceed as described in Par. 13.5.

At the end of the procedure, the wheel balancing conditions can be checked by performing a trial spin.

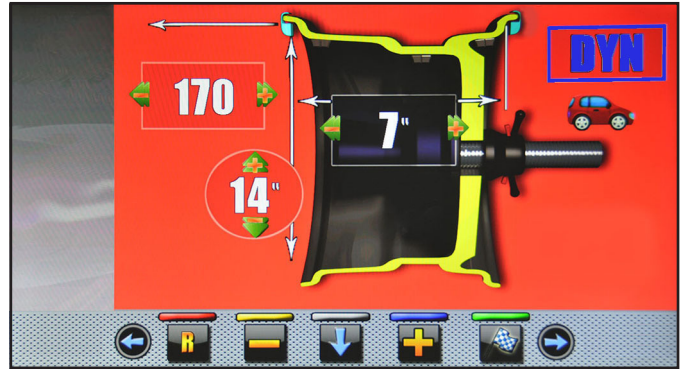

The procedure has now been completed.

13.7.5 ALU-S

ALU-S program permits balancing wheels by two fitting adhesive weights on the outer and inner sides of the rim. Enter the measurements (see Par. 13.2.1 or 13.6.1) and proceed as described in Par. 13.5.

At the end of the procedure, the wheel balancing conditions can be checked by performing a trial spin.



The procedure has now been completed.

13.7.6 ALU-S1

ALU-S1 function permits balancing wheels with light alloy rims by fitting adhesive weights on the outer side and weight with clip on inner side of wheel (at "12 o'clock").

Enter the measurements (see Par. 13.2.1 or 13.6.1) and proceed as described in Par. 13.5 (the inner weight is with clip).

At the end of the procedure, the wheel balancing conditions can be checked by performing a trial spin.

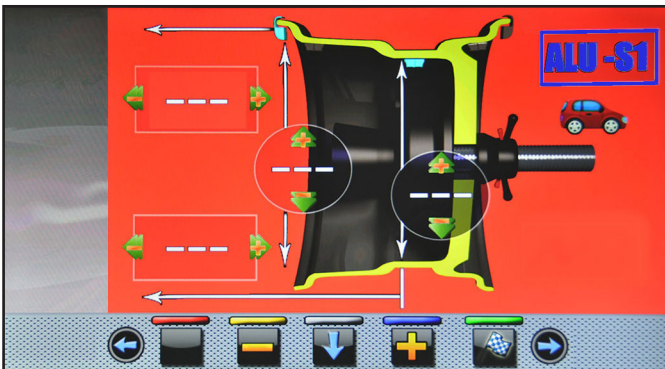

The procedure has now been completed.

13.7.7 ALU-S2

ALU-S2 function permits balancing wheels with light alloy rims by fitting two adhesive weights: one on the outer and one on inner sides of the rim (the inner weight is at 12 o'clock).

Enter the measurements (see Par. 13.2.1 or 13.6.1) and proceed as described in Par. 13.5.

At the end of the procedure, the wheel balancing conditions can be checked by performing a trial spin.

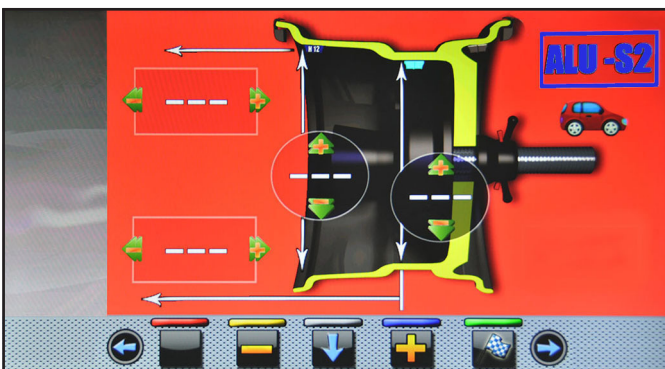

The procedure has now been completed.

13.7.8 ALU-1

ALU-1 function permits balancing wheels with light alloy rims by fitting adhesive weights on the outer and inner sides of the rim at "12 o'clock".

Enter the measurements (see Par. 13.2.1 or 13.6.1) and proceed as described in Par. 13.5.

At the end of the procedure, the wheel balancing conditions can be checked by performing a trial spin.

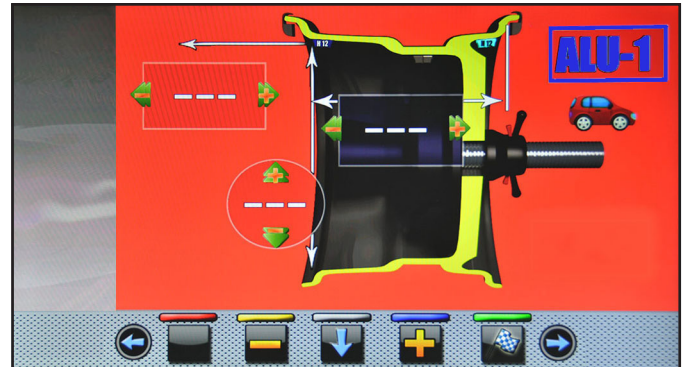

The procedure has now been completed.

13.7.9 ALU-2

ALU-2 function balances wheels with light alloy rims by fitting adhesive weights on the outside and inside of the rim. The position of the outer weight is not visible but hidden inside. Enter the measurements (see Par. 13.2.1 or 13.6.1) and proceed as for dynamic unbalance.

At the end of the procedure, the wheel balancing conditions can be checked by performing a trial spin.

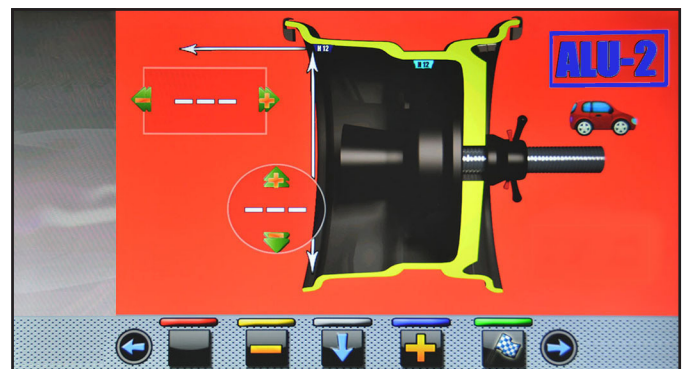

The procedure has now been completed.

13.7.10 ALU-3

ALU-3 function is a procedure that uses mixed weights to offset wheel unbalance: weight with clip on inner side of wheel, adhesive weight on outer side, not visible because inside the rim.

Enter the measurements (see Par. 13.2.1 or 13.6.1) and proceed as for dynamic unbalance.

At the end of the procedure, the wheel balancing conditions can be checked by performing a trial spin.

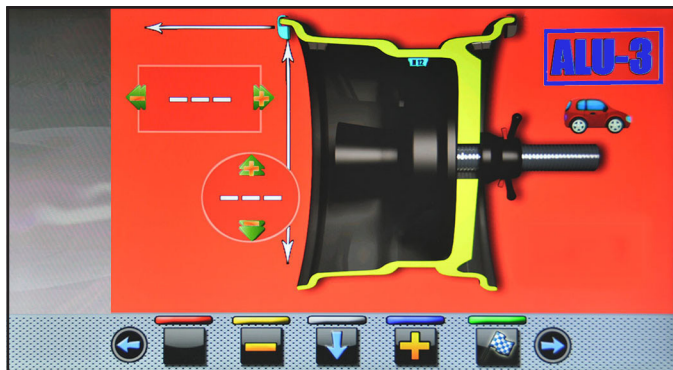

The procedure has now been completed.

13.7.11 ALU-4

ALU-4 function is a procedure that uses mixed weights to offset wheel unbalance: weight with clip on inner side of wheel, adhesive weight on outer side.

Enter the measurements (see Par. 13.2.1 or 13.6.1) and proceed as for dynamic unbalance.

At the end of the procedure, the wheel balancing conditions can be checked by performing a trial spin.

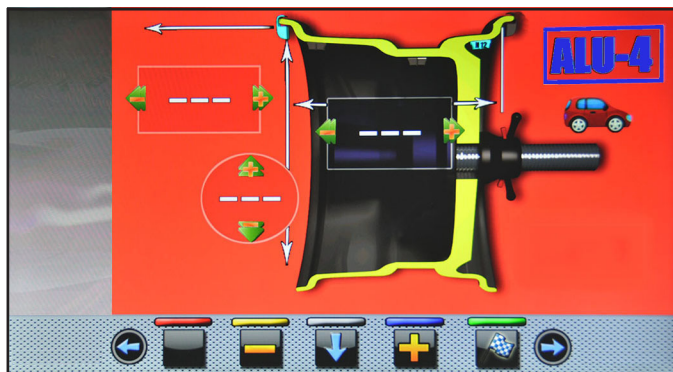

The procedure has now been completed.

13.8 Optional balancing programs

13.8.1 ECO-WEIGHT mode



TO USE THE ECO-WEIGHT PROCEDURE IT IS NECESSARY THAT THE DISTANCE-DIAMETER CALIPER ARM IS ENABLED IN THE "OPTIONS" MENU DESCRIBED IN PAR. 14.1.



THE ECO-WEIGHT PROCEDURE CAN ONLY BE USED WITH THE PROGRAM ALU-S.

This procedure represents a modern system for the reset of the unbalance in order to reduce weights consumption. This procedure ensures a fastest execution of the operations, thanks to a lesser number of spins and repositioning.

After making the wheel spin in ALU-S mode, the monitor shows the total of 2 adhesive weights to precisely correct STATIC and DYNAMIC unbalance.



It is possible to fit a single weight at a predetermined distance from the machine, so as to optimize the weight consumption and reduce both the DYNAMIC and any remaining STATIC unbalance as much as possible. Unlike the standard STATIC procedure, the ECO-WEIGHT procedure, though only using one weight, also considerably reduces the DYNAMIC unbalance, because the fitting distance of the weight on the rim is also calculated.

From ALU-S unbalance results page, if there is con-

siderable static unbalance, press the button  to display on the following monitor screen:



Press button  to select such procedure and bring automatically the wheel into weight fitting position.

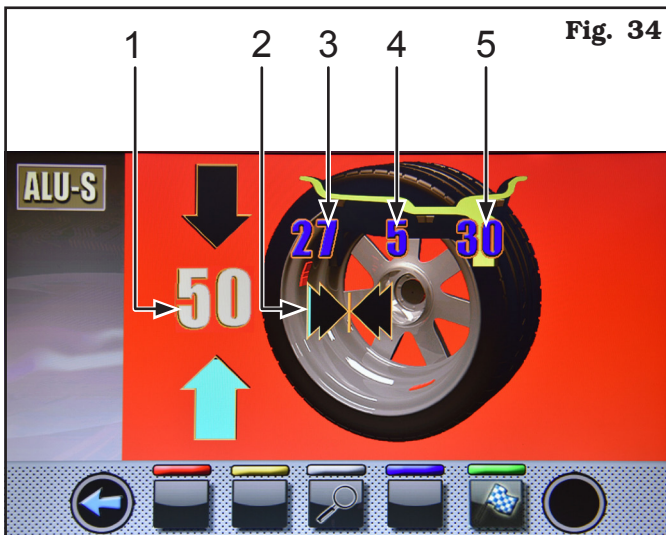

Fig. 34

KEY

- 1 - Only weight to be fitted
- 2 - Arrows indicating the weight fitting point with distance-diameter caliper arm
- 3 - Residual dynamic unbalance value (if the value is blue it is not to carry out ECO-WEIGHT procedure)
- 4 - Static unbalance value (if the value is blue it is not to carry out ECO-WEIGHT procedure)
- 5 - Residual dynamic unbalance value (if the value is blue it is not to carry out ECO-WEIGHT procedure)

Press the brake pedal and fit the adhesive weight inside pliers as shown in **Fig. 35**.

Fig. 35 Fit the adhesive weight in the pliers of the gauge rod



Pull out the gauge rod until the arrows (**Fig. 34** ref. 6) turn green.

Fit weight on the position where pliers touches the wheel **Fig. 36**



At the end of the procedure, the wheel balancing conditions can be checked by performing a trial spin. The ECO-WEIGHT procedure has now been completed.

IMMEDIATELY AFTER HAVING SELECTED THE ECO-WEIGHT PROCEDURE, YOU CAN KNOW IN ADVANCE THE TWO DYNAMIC UNBALANCES AND THE STATIC RESIDUE IN ORDER TO DECIDE WHETHER IT IS CONVENIENT TO CONTINUE (SEE FIG. 34). IF BOTH DYNAMIC UNBALANCES AND STATIC RESIDUE ARE SHOWN AS WHITE VALUES ON THE MONITOR, THIS MEANS THAT THE PROGRAM HAS DECIDED THAT IT IS BETTER TO CONTINUE. WHILE IF, ON THE OTHER HAND, ONE OR MORE VALUES ARE BLUE, THE PROGRAM SUGGESTS USING THE STANDARD ALU-S PROCEDURE.

PRESS BUTTON  ONCE, THE TWO RESIDUAL DYNAMIC UNBALANCES WILL BE DISPLAYED ON MONITOR.

PRESS BUTTON  ONCE MORE, THE CALCULATED REAL STATIC WEIGHT AND THE RESIDUAL STATIC WEIGHT WILL BE DISPLAYED ON SCREEN.

IF YOU ARE NOT WISHING TO OPERATE WITH ECO-WEIGHT PRO-

CEDURE, PRESS BUTTON  ONCE MORE, ALU-S UNBALANCE VALUES WILL BE DISPLAYED AGAIN.

WHILE IF YOU WISH TO OPERATE WITH THE ECO-WEIGHT PROCE-

DURE, PRESS BUTTON  FOR

A LONGER TIME (OR KEY ) TO GO BACK TO THE RESIDUAL DYNAMIC/ECO-WEIGHT WEIGHT DISPLAY SCREENS.

13.8.2 SPLIT mode

Split procedure proves useful when the dynamic unbalance of a wheel is fairly high and the weight to be fitted is not available, for instance a 100 g weight. It's possible then to correct the unbalance dividing the amount of weight into two weights of smaller size.

Split procedure eliminates errors by using "DYNAMIC" program, for example by manually fitting two 50 g weights close to one another, instead of only a 100 gr one.

For example:

100 g WEIGHT TO BE FITTED TO
CORRECT UNBALANCE



TWO SMALLER WEIGHTS (50g)
FITTED MANUALLY



TWO SMALLER WEIGHTS (55g)
USING SPLIT PROCEDURE





Proceed to "DYNAMIC" unbalance measurement displaying by performing a standard wheel spin.



Once detected the unbalance values, verify that the machine displays the ability to use the "SPLIT" option

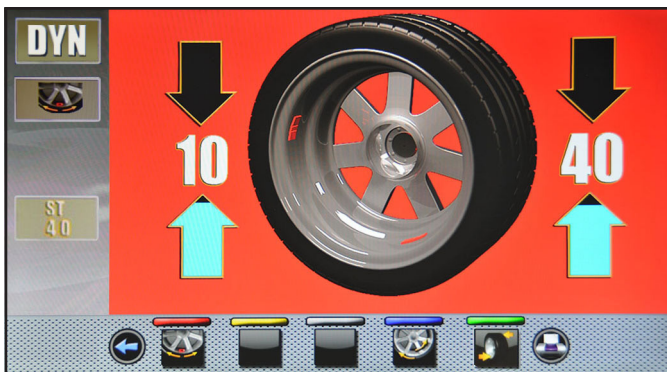

(Fig. 31 ref. 4b). Press button  to shift to the next screen page.



Press button  to enter "SPLIT" function. On the monitor screen will be displayed where you must enter the value of the weights to be fitted.



Press button  to select the outer weight to edit.

Press buttons  or  to increase or decrease the total weight to be fitted.



THE BLUE VALUE INDICATES WHICH VALUE IS ACTIVE AND YOU ARE EDITING.



THE HIGHER THE CHOSEN WEIGHTS VALUE IS, THE MORE THEY WILL BE SPACED.

After choosing the value of the weights to be fitted,

press button  to position the wheel for the application of the 1st clip weight.



THE TWO GREEN ARROWS INDICATE THAT THE WHEEL IS PROPERLY POSITIONED FOR THE APPLICATION OF THE 1ST WEIGHT.

Fit the clip weight of the chosen value at "12 o'clock"

on the outside of the wheel. Press again button  to position the wheel for the fitting of the 2nd clip weight.



Fit the clip weight of the chosen value at "12 o'clock"

on the outside of the wheel. Press button  to highlight the value of the weights to be fitted on the inside of the wheel.



Repeat the above steps for the weights to be fitted inside the wheel.

At the end perform again a checking spin to see that you have applied the weights correctly.

13.8.3 Weights hidden behind spokes mode

Adhesive correction weight positioning may not look attractive on some types of rims. In this case, "weights hidden behind spokes" mode can be used: it splits any correction weight on the outer side into two parts to be hidden behind rim spokes. It can be used ONLY in ALU-S mode.

Proceed to ALU-S unbalance measurement displaying by performing a standard wheel spin.



Once detected the unbalance values, verify that the machine displays the ability to use the "spokes" options (Fig. 31 ref. 4b).

Press button  to shift to the next screen page.



Press button  to enter the relevant function. On the monitor the next screen page will be displayed:



Bring any spoke upwards at "12 o'clock" position and
 press the button to confirm and continue.

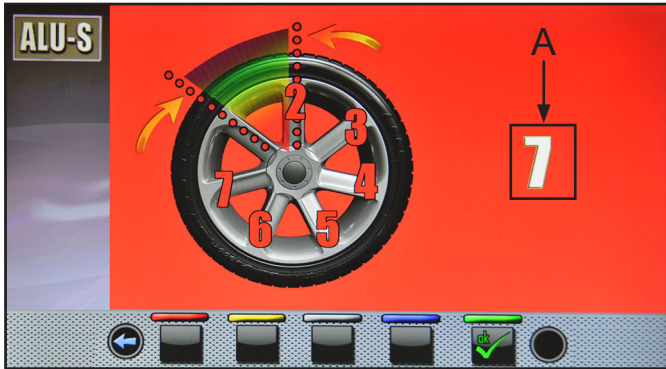

Lead to "12 hours" the 2nd spoke. The machine will automatically calculate the total number of spokes. If the value shown on the screen (A) is correct, press the
 button

The machine automatically calculates weight position in two positions hidden behind the spokes. The monitor shows the amount of weight to be applied behind the FIRST spoke and the rim will reach the position to apply the FIRST weight.



Extract the gauge rod, and fit the FIRST weight in the position shown by the machine, as explained in



Par. 13.5.1. Press the button
 to confirm that they have applied the FIRST weight and to automatically position the wheel for the fitting of the 2nd weight. The monitor shows the amount of weight to be applied behind the SECOND spoke.

Pull out the gauge rod and fit the SECOND weight in the position shown by the machine, as done for the first weight.



Press the button to confirm that you have applied the SECOND weight and get back to the initial situation of unbalance, before performing the "weights hidden behind the spokes" procedure. Perform another test spin. The "weights hidden behind the spokes" procedure is completed.

Complete the operation by adding an additional weight inside the rim as required by the selected mode (ALU-S).

13.8.4 Matching mode

The Matching procedure offsets strong unbalance, reducing the weight quantity to be fitted on the wheel to achieve balancing. This procedure permits reducing unbalance as much as possible by offsetting the tyre unbalance with that of the rim in any used program.

Proceed to unbalance measurement displaying by performing a standard wheel spin.



THE MATCHING PROCEDURE CAN BE CARRIED OUT ONLY IF THE STATIC UNBALANCE IS > 30 G.



Once detected the unbalance values, verify that the machine displays the ability to use the "matching" options (Fig. 31 ref. 4a).



Press button to shift to the next screen page.



Press button to enter the relevant function. On the monitor the next screen page will be displayed:

ER250R

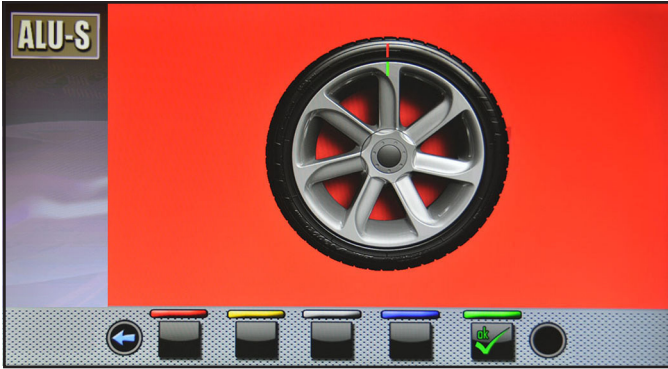

STEP 1. Move the slider on the flange to the "12 o'clock" position. Make a reference mark, using chalk for instance, on the rim and tyre, in line with the arrow on the flange, so as to be able to fit the rim back on in the same position on the machine.

Make a reference mark on the rim and tyre, in line with the arrow on the flange

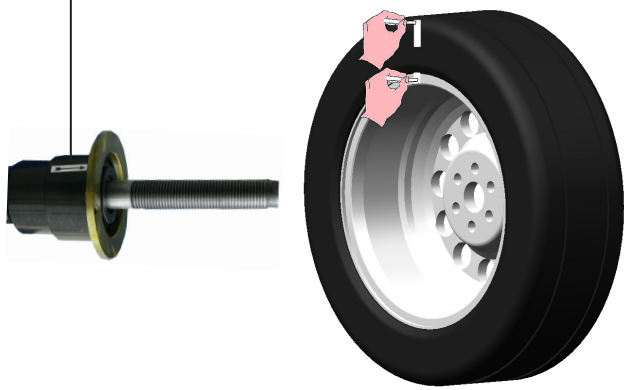

Press button  to confirm that step 1 has been completed.

On the display the next screen page will be displayed:

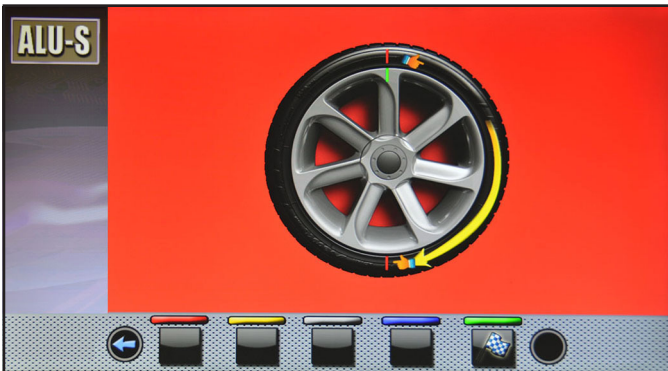

STEP 2. Remove the wheel from the wheel balancer. Remove the tyre and turn it on the rim through 180°.

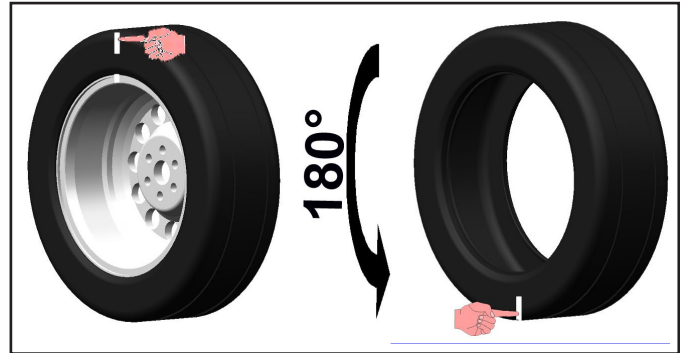

Fit the wheel back on the wheel balancer, positioning the reference mark on the rim in line with the arrow on the flange.

Position the reference mark on the rim in line with the arrow on the flange

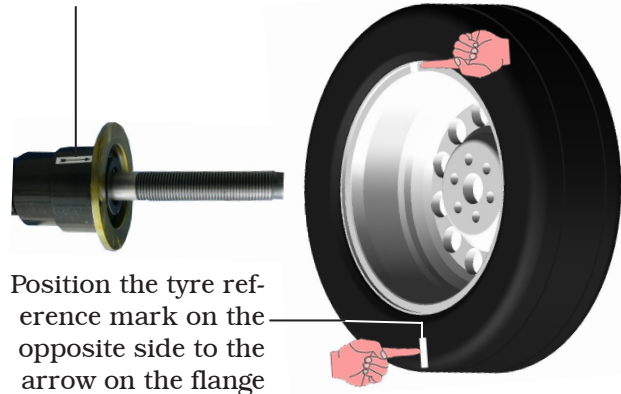

Position the tyre reference mark on the opposite side to the arrow on the flange



Press button  to confirm that step 2 has been completed.

On the display the next screen page will be displayed suggesting to perform a spin of the wheel.



After having fitted wheel back in position, close the protection guard to make an automatic wheel spin. At the end of the spin the monitor will display the following screen:

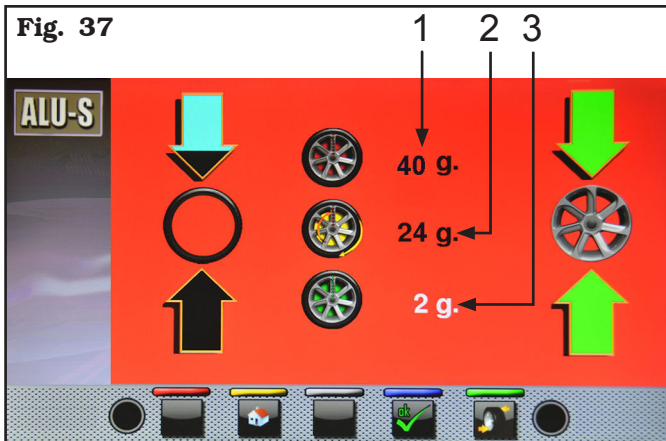

In this screen you will see the dynamic unbalance that the wheel had before performing the operation (**Fig. 37 ref. 1**), the dynamic unbalance after having rotated the tyre through 180° compared to the rim (**Fig. 37 ref. 2**) and the unbalance which can be obtained following the directions of the machine (**Fig. 37 ref. 3**).

STEP 3. If the value of possible unbalance reduction is high, you can proceed as follows:

- Cancel the previously made reference marks. Put new signs, as described below.



- Press the button  to bring the wheel into position.



Make the reference mark on RIM at "12 o'clock" (see **Fig. 38**).

reference mark on RIM

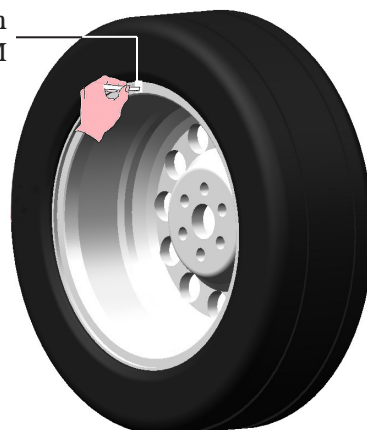



Fig. 38



- Press the button  to bring the wheel into position.



Mark the reference mark on the TIRE at "12 o'clock" position.



- Press button  to confirm that step 3 has been completed.

STEP 4. Remove the wheel from the wheel balancer. Dismount and remount the tyre on the rim so as to bring the two reference marks (rim and tyre) to coincide. Refit the wheel on the balancer (see **Fig. 39**) with the two reference marks next to the arrow on the flange.

Fig. 39

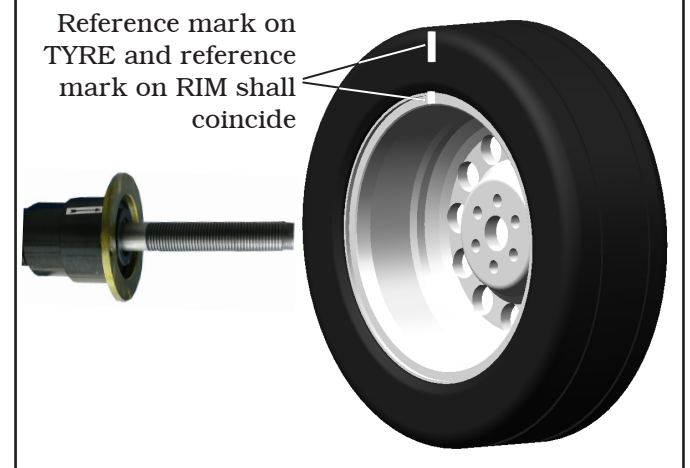

- Press button  to confirm that step 4 has been completed.

Perform another spin closing the protection guard, to check the expected unbalance reduction and correct any residual unbalance, as described in Chap. 13.5.1.

13.9 Special balancing programs

13.9.1 Pax

PAX mode is a special procedure specially devised to balance wheels using the "PAX System ®". 2 adhesive weights on different planes are used on rim inner side.

To launch a PAX measurement, proceed as follows:

- Make sure there are no stones and/or mud on the wheel. Remove any counterweights. Fit the wheel and make sure it is properly fastened (see Chap. 11).

- Press  button from "Home" page. On the screen

that appears, press the button  to switch to measuring mode selection screen below.



Use the arrows  or  to select PAX mode.

At the end press push button . The machine will be configured as follows to perform the measurement and on the video screen will appear the indication of the specific measures of the selected wheel type.

- Close the protection guard to perform the automatic wheel spin.

In just a few seconds, the wheel runs at normal speed and the monitor shows wheel rotation.

After the spin, the wheel stops automatically, taking into account the measured unbalance so that the fitting position of the weight will be at "12 o'clock".

The monitor show the weight required to correct the unbalance.

Open the protection guard and proceed to fit the adhesive weight as shown for the ALU-S mode (see Par. 13.7.5).

13.10 Recalculation function

After making a spin, the wheel automatically stops, indicating the weight/s to be fitted and its/their position. In case the operator does not want the type of wheel balance proposed by the machine (program type, weights size, etc ...), proceed with the re-calculation of the wheel balancing without rerunning the spin of the wheel.

To do this, proceed as described below:

- press the button  to return to the measures detection/program selection page;
- select a new balancing program as indicated in Par. 13.2.2;
- take with the gauge arm the measures required by the selected program;

- press button  to perform the re-calculation. The monitor will display the weights and the positions in which they will be applied.



If also in this case the operator should decide to further modify the balancing program, it is sufficient to proceed as described above without having to spin the wheel.

When the result of the recalculation does not satisfy the operator, it is recommended to do a spin of the wheel to confirm the findings from the operation of recalculation itself.

After the launch of the wheel, the machine, in addition to displaying the unbalance value, draw up automatically all the programs measurement fields that are consistent with those measures that were taken previously and at the same time erases all measures which are not consistent.

**13.11 Wheel balancing in Motorcycle mode
(with distance caliper extension Kit)**

By enabling "motorcycle wheel balancing" function, the wheel balancers can also balance motorcycle wheels. Before detecting the wheel sizes (see Par. 13.2.2), select motorcycle wheel balancing mode proceeding as described below:

press button  and then button . On the

screen that appears, press the button  to switch to programs and measurements acquisition selection screen below.



Use arrows  and/or  to select the mode desired.

At the end press push button .

The machine will be configured as follows to perform the measurement in the desired mode and on the screen will appear an indication showing the measures that will be acquired.

The "motorcycle" mode automatically recalculates the wheel distance measurement, increasing it by the length of the extension supplied with distance caliper extension kit (kit available on demand).



! THE EXTENSION MUST BE FITTED ONLY WHEN BALANCING IS PERFORMED IN "MOTORCYCLE" MODE.

i TO MOUNT THE EXTENSION AND THE COMPONENTS OF CALIPER EXTENSION KIT, PLEASE REFER TO THE SPECIFIC INSTRUCTIONS INCLUDED IN THE KIT.

Balancing procedures are identical for both modes (car/motorcycle).

By selecting motorcycle mode, besides DYNAMIC balancing (see Par. 13.7.4) STATIC balancing and/or ALU-S (Par. 13.7.1 and/or 13.7.5) can also be performed.

14.0 USER MENU (OPTIONS AND CALIBRATION)

From the main page "Home" press the button  to move to the next screen page and the button  to access the user menu. On the monitor, the following screen appears where you can enter the password.



The user login password is: **1234**. After entering the correct password you will see the following screen:

Fig. 40



1 2

KEY

- 1 - Options menu push button
- 2 - Calibrations menu push button

14.1 Options menu



Press button  to display the monitor screen to enable/disable the options as shown below:



Press three times the button  to go to the next page of options.



To go back to the previous page of options, press two



times the button .

To enable / disable individual functions simply high-

light the icon using the buttons  and/or 

and press the button .

Pressing the button  may involve, besides, the change in the unit of measure from "mm" to "inch" and vice versa (where applicable) or access to a sub-screen for values settings values (see Par. 14.1.1 or 14.1.2). After you select/deselect the desired options, exit the

menu by pressing push button .

List of available options



Enable/disable the protection guard/spin (enabled on machine delivery).



Enable/disable the distance/diameter detection caliper (enabled on machine delivery).

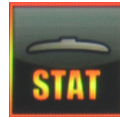

Enable/disable the display of static threshold after each spin (enabled on machine delivery).



It allows you to set the thresholds for each of the balancing mode weights (see Par. 14.1.1).



Enable/disable the pneumatic brake after the spin (disabled on machine delivery).



When activated, gram weight display unit is set (activated on machine delivery).

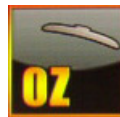

When activated, ounce weight display unit is set. When this option is enabled, weight display unit can be modified from ounces to grams and vice versa (disabled on machine delivery).

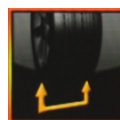

It allows you to enable/disable the width function detected by Rim width measuring device (enabled when fitted as standard on the machine).



Enable/disable the ECO-WEIGHT function (enabled on machine delivery).

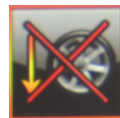

Enable/disable the positioning of weights at "6 o'clock" (disabled on machine delivery).

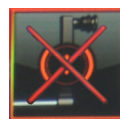

Enable/disable the lock function for caliper arm in position (disabled on machine delivery).

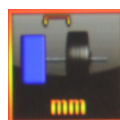

It allows you to change the unit of measure of the distance of the weights fitting point from mm to inches and vice versa.

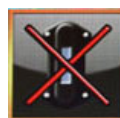

Enable/disable the led light (disabled on machine delivery).

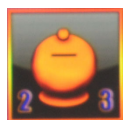

Enable/disable the dynamic residues in the ECO-WEIGHT function (enabled on machine delivery).

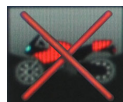

Enable/disable the functions of motor-cycle balancing (disabled on machine delivery).

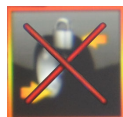

Enable/disable the encoder mounted on the spin motor (disabled on machine delivery).

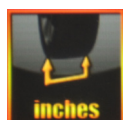

It allows you to change the unit of measurement of the rims width from mm to inches and vice versa.

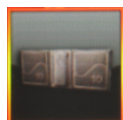

It allows you to set the size values of weights (see Par. 14.1.2).

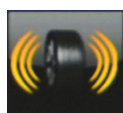

Enable/disable the RUN-OUT functions (enabled on machine delivery).

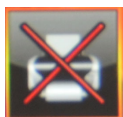

Enable/disable machine print functions (disabled on machine delivery).

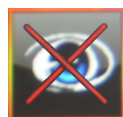

Enable/disable weight measure manual setting, by the readout of measures printed on the rim and on the graduated scale of the distance diameter caliper (disabled on machine delivery).

NOTE: it is activated only if distance-diameter caliper is disabled.

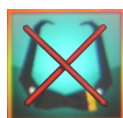

Enable/disable the use of the manual caliper to measure rim width (disabled on machine delivery).

NOTE: it is activated only if distance-diameter caliper is disabled.

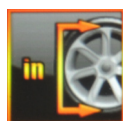

It allows you to change the unit of measurement of the rim diameter from mm to inches and vice versa.

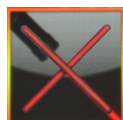

Enable/disable the function of weights positioning laser (disabled on machine delivery).

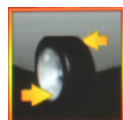

Enable/disable the repositioning of the wheel at the end of the spin (enabled on machine delivery).



Enable/disable the function of weights positioning laser wheel inner/outer side at "12 o'clock "(disabled on machine delivery).

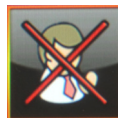

Enable/disable user function (disabled on machine delivery).

14.1.1 Lower weight limit

Correction weight below a certain limit is normally shown equal to zero. This limit can be set from 10 g to 1 g (from 0.5 oz to 0.05 oz).

At the end of the spin however, by pressing the button



, the weight can be displayed with max resolution of 1 g (0.05 oz), not considering the set lower limit.



LOWER LIMIT'S FACTORY SETTING FOR DYNAMIC WHEEL BALANCING MODE IS 5 g (0.25 oz). THE LOWER LIMIT FOR ALL THE OTHER MODES IS SET AT 7 g (0.35 oz).

	Default values		Work range	
	g	oz	g	oz
1 →	5	0.25	2 ÷ 50	0.05 ÷ 2.00
2 →	7	0.35	2 ÷ 50	0.05 ÷ 2.00
3 →	5	0.25	2 ÷ 50	0.05 ÷ 2.00
4 →	100	100	0 - 50 - 100 150 - 200	0 - 50 - 100 150 - 200
	%		%	

KEY

- 1 – Lower weight limit in the DYNAMIC program to display "OK" (default value 5 g (0.25 oz))
- 2 – Lower weight limit in the ALU-STATIC program to display "OK" (default value 7 g (0.35 oz))
- 2 – Weights display resolution (default value 5 g (0.25 oz))
- 4 – Weight % reduction in ECO-WEIGHT function (0 ÷ 200) (default value 100)



- Press the push button to shift among the field to modify.

- Press or to modify the highlighted value.



THE BLUE-COLOURED-VALUE IS THE ACTIVE FIELD AND THE MODIFIABLE ONE.

14.1.2 Setting adhesive weight dimensions and static threshold percentage

To ensure the balancing machine precisely calculates the dimensions and total adhesive weights, set the height (thickness) and width of the adhesive weights at your disposal (see Fig. 41).

Fig. 41

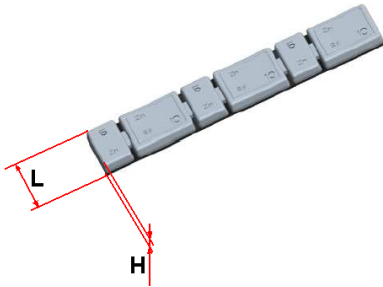

To carry out this setting, press the icon . You will see the following screen:



KEY

- 1 - Weights thickness (height) (default value 4 mm)
- 2 - Weights width (default value 19 mm)

From this screen page, change the size values of weights

using the buttons and .



THE BLUE-COLOURED-VALUE IS THE ACTIVE FIELD AND THE MODIFIABLE ONE.

14.1.3 User management

The "User Management" function is disabled on machine delivery. To enable it, proceed as described in Para 14.1. After enabling, the icon will be displayed on every page (Fig. 42 ref. 1).

The wheel balancers can be used simultaneously by 4 different users.

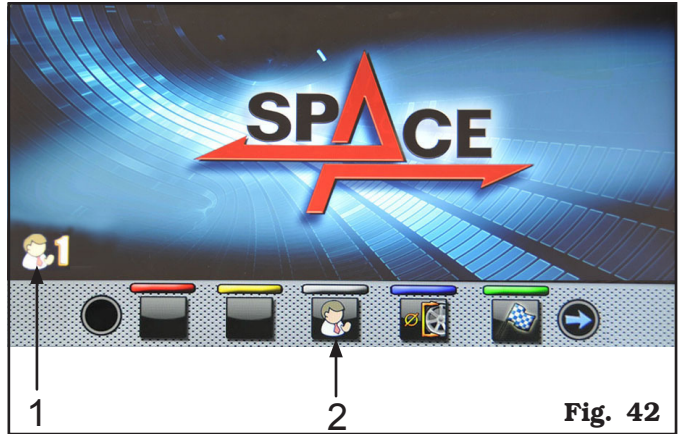

Fig. 42

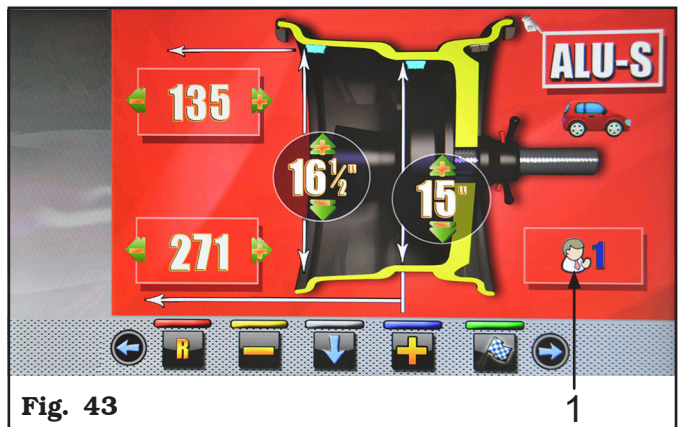
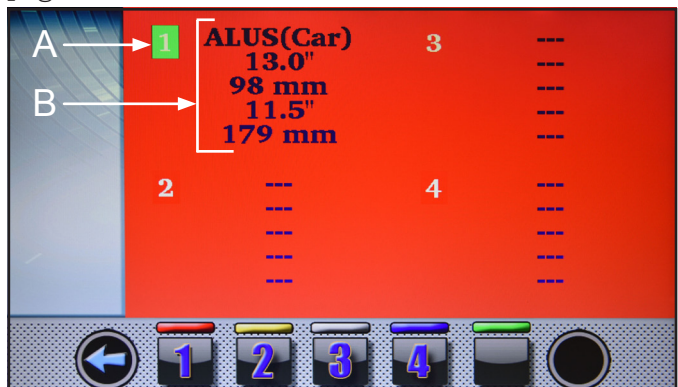

Fig. 43

Press button , shown on the monitor (Fig. 42 ref. 2) or select the field (Fig. 43 ref. 1) and subse-

quently press the button to display the screen page below:



KEY

- A - Program used in the last carried out spin
- B - Acquired measurements for the last carried out spin

Press any of the available numbers on the buttons at the bottom of the page to select the corresponding user. The system stores the data relating to the last performed spin according to the different operators. You can recall the desired user each time the program displays the specific button (**Fig. 42 ref. 2** and **Fig. 43 ref. 1**). The measurements stored for each user are lost when the machine is switched off. User management is valid for any wheel balancer function.



TO ENABLE OR DISABLE "USER MANAGEMENT" FUNCTION, SEE PARAGRAPH 14.1. IF THE FUNCTION IS DEACTIVATED, BUTTON  IS DISPLAYED.

14.2 Machine calibrations

Press the button  (**Fig. 40 ref. 2**) to display the following screen page on monitor:

Fig. 44

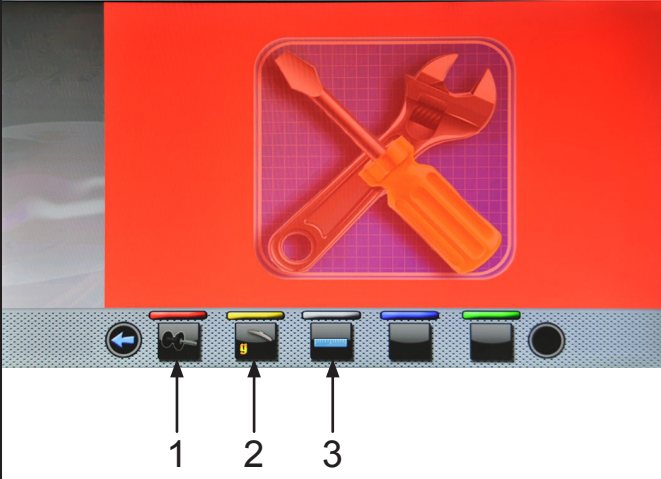

KEY
1 – Chuck “0” (zero) calibration
2 – Weight measurement sensors calibration
3 – Gauge calibration

14.2.1 Chuck “0” (zero) calibration

Press the button  (**Fig. 44 ref. 1**) to display the following screen page on the monitor:

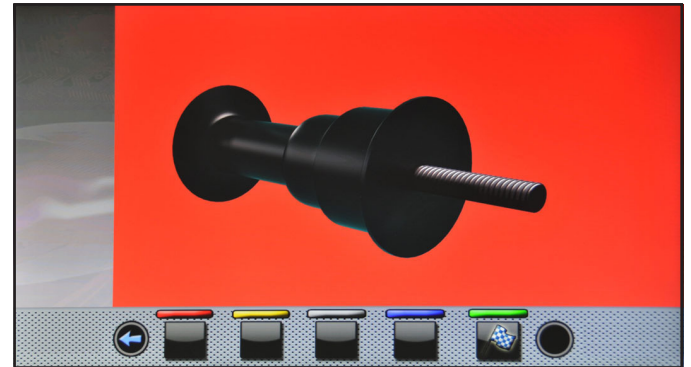

After making sure that the spindle is unloaded (no wheel or mounted accessories), press button  and close the guard. The chuck will rotate for a few minutes until you see the screen below:

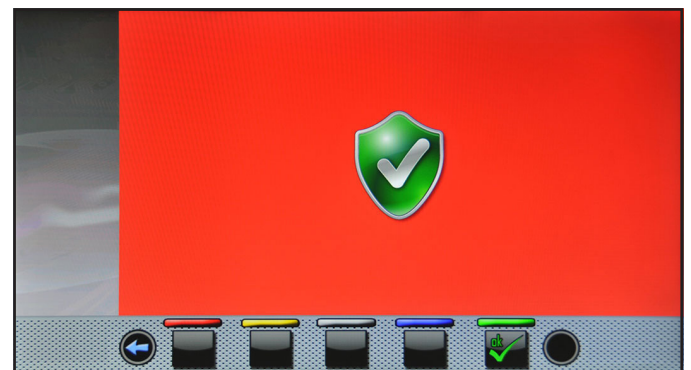

At this point the machine has all its measuring fields.

Press button  to return to calibrations screen page.

14.2.2 Weight measurement sensors calibration



ASSEMBLE A BALANCED WHEEL ON THE SPINDLE AND PERFORM THE SPINDLE "0" (ZERO) CALIBRATION PROCEDURE DESCRIBED IN PAR. 14.2.1 (WITH WHEEL MOUNTED).



- Press the button  (Fig. 44 ref. 2) to display the following screen page on the monitor:

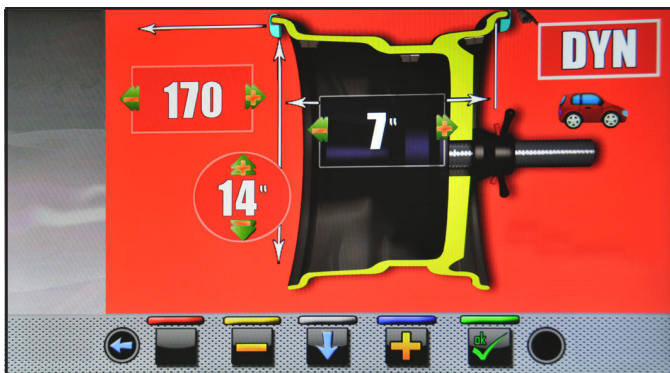

- Set the size of the rim on the chuck using the distance-diameter caliper arm.
- Set the rim width using one of the following calipers:
 - Manual caliper (provided as standard with the machine).
 - Rim width measuring device (optional).



- Press button  and close the guard to perform the 1st spin of the wheel without weights.

- At the end, on the monitor will appear the following screen, saying that you should apply a weight of 100 g to the "12 o'clock" outer rim.

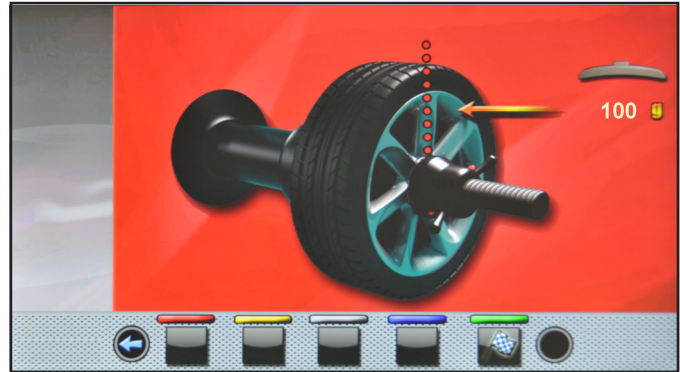

APPLY THE WEIGHT AT A POINT IN WHICH BOTH SIDES OF THE RIM THERE IS THE POSSIBILITY OF APPLYING A CLIP WEIGHT OF 100 g.

- Apply the weight and position it perfectly to the "12 o'clock".



- Press the button  and close the guard to perform the 2nd spin of the wheel (100 g weight placed on the outside of the wheel).
- At the end the following screen will appear on the monitor, suggesting to remove the weight of 100 g previously applied on the outer side and apply it on the inside of the rim.

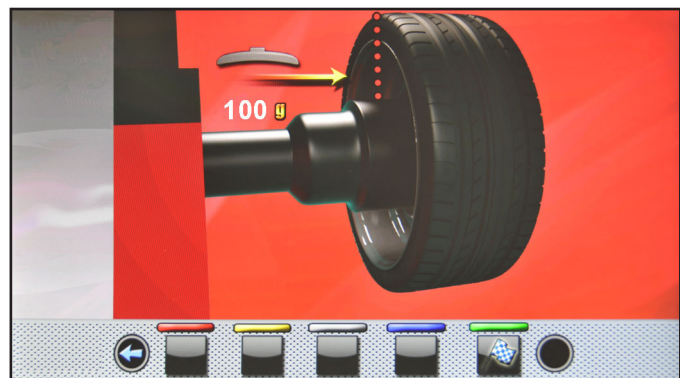

- Turn manually the wheel until you have the weight of 100 g on the outer side at "12 o'clock".
- Press the brake pedal and hold it down during the whole the following operation to avoid unexpected rotation of the spindle.
- Remove the weight from 100 g from the outside of the wheel and apply it on the inner side at "12 o'clock".
- Close the guard to perform the 3rd spin of the wheel (100 g weight placed on the inside wheel).

At the end of the rotation, the video screen below will be displayed to indicate that the operation is finished.

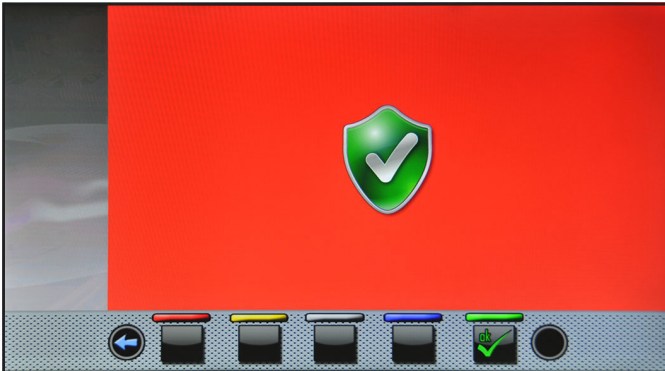

WHEN THE OPERATION IS CONCLUDED, REMOVE THE WHEEL FROM THE CHUCK AND PERFORM A COMPLETE CALIBRATION PROCEDURE "0" (ZERO) CHUCK AS DESCRIBED IN PAR. 15.2.1.

14.2.3 Gauge calibration



Press the button (Fig. 44 ref. 3) to display the following screen page on the monitor:

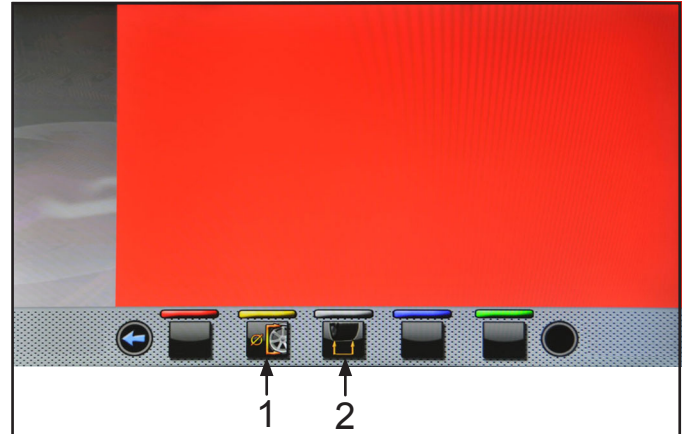

KEY

- 1 - Distance-diameter caliper calibration
- 2 - External data gauge calibration

Distance-diameter caliper calibration



Press the button to display the following screen page on the monitor:

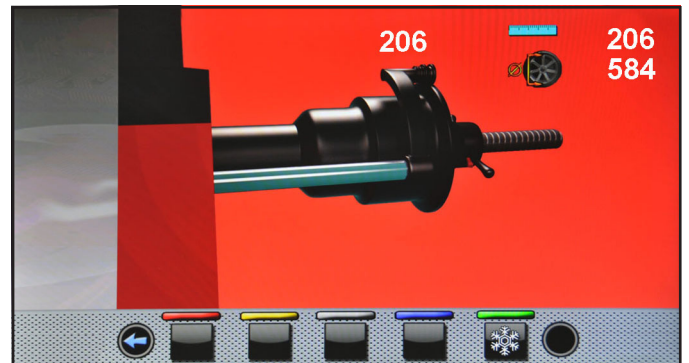

Place the gauge (**Fig. 44 ref. 1**) on the chuck flange (**Fig. 44 ref. 2**).

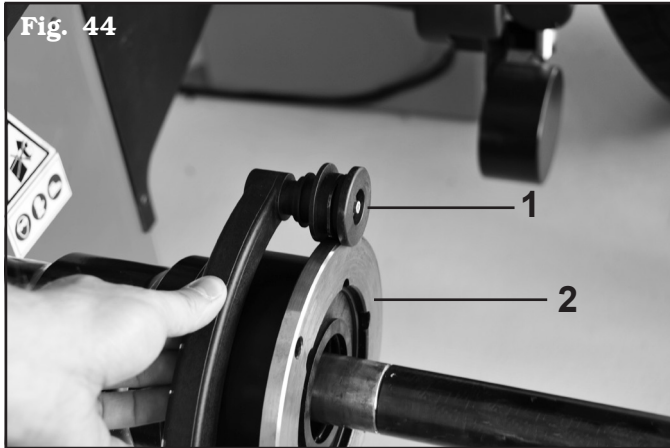

The following screen will appear on the monitor to indicate the measured values:

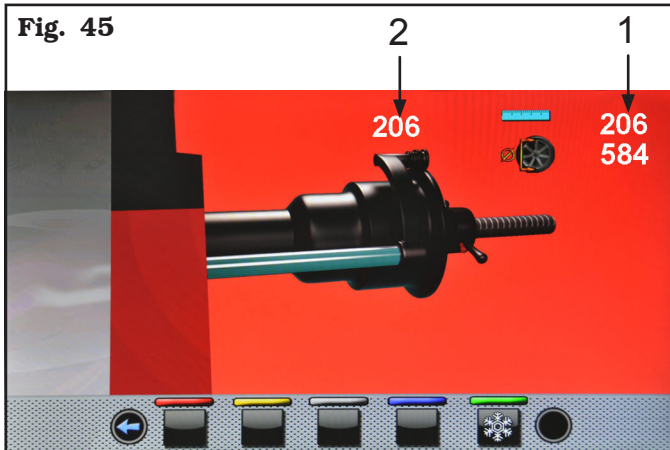

- The value next to the symbol "scale" (**Fig. 45 ref. 1**) must be equal to the value positioned above the caliper (**Fig. 45 ref. 2**) ± 1 mm.



IF THE MEASUREMENT GAUGE IS NOT EXACTLY POSITIONED ALONG THE UPPER EDGE OF THE FLANGE AND CONSEQUENTLY IF DISTANCE MEASUREMENT IS NOT 206 ± 1 MM, WHEN THE MEASUREMENT IS CONFIRMED, THE PROGRAM WILL NOT PASS ON TO THE NEXT STAGE. TRY REPOSITIONING THE GAUGE FERRULE ALONG THE UPPER EDGE OF FLANGE AND, IF THE MEASUREMENT CONTINUES NOT TO BE BETWEEN 206 ± 1 MM AND THE PROGRAM DOES NOT PASS ON TO THE NEXT CALIBRATION STAGE, CONTACT THE AFTER-SALES SERVICE.



- Press push button

The following screen will appear on the monitor:



- Place the gauge as shown in the following figure:



- Press push button. Wait a few seconds until you see the following screen:

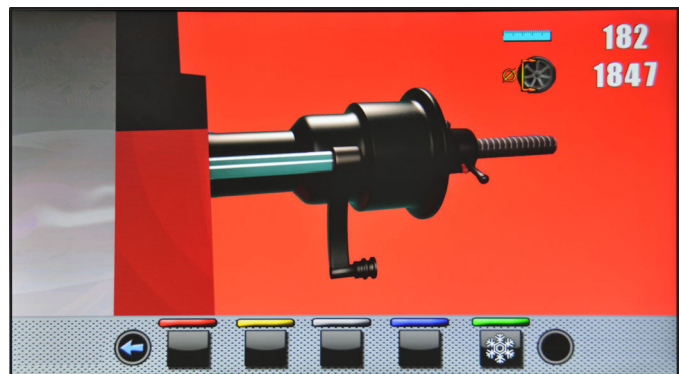

- Place the gauge against the chuck in the lower part of it but on a smaller diameter than before as indicated on the image on the monitor.



- Press push button . On the monitor the next screen page will be displayed:

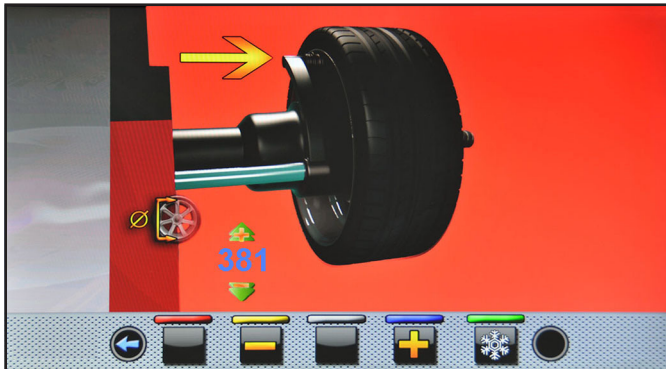

Measure the exact diameter of a rim (see **Fig. 46**) and place it on the screen on the monitor by pressing the



Fig. 46

- Fit the measured wheel on the balancer and lock it on the chuck.
- Turn the gauge ferrule (**Fig. 47 ref. 1**) on the inner edge of the wheel upwards (see **Fig. 47**).



Fig. 47



- Press button  to end the operation. On the monitor the next screen page will be displayed:

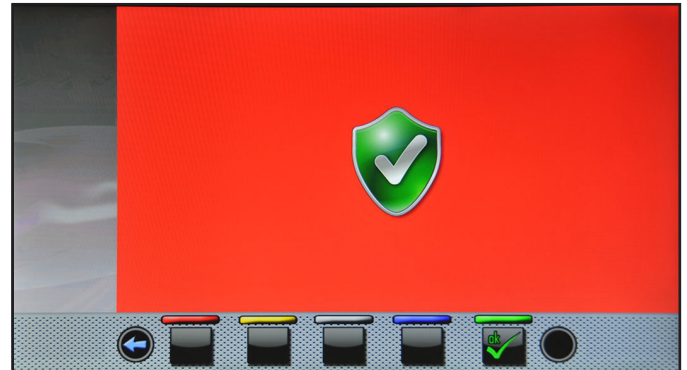

The calibration of the distance-diameter caliper is finished.

Calibration of external data gauge (optional)



- Press the button  to display the following screen page on the monitor:

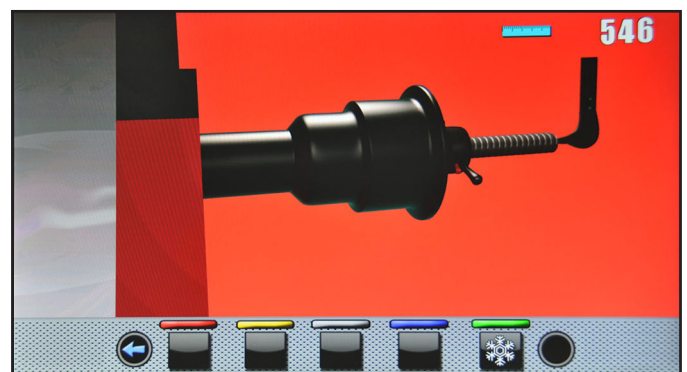

**TO PERFORM THIS CALIBRATION,
THE CHUCK MUST BE UNLOADED
(NO WHEEL OR ACCESSORIES
MOUNTED ON IT).**

ER250R

Move the tip of the width measuring device (**Fig. 48 ref. 1**) in line with the chuck edge (**Fig. 48 ref. 2**).

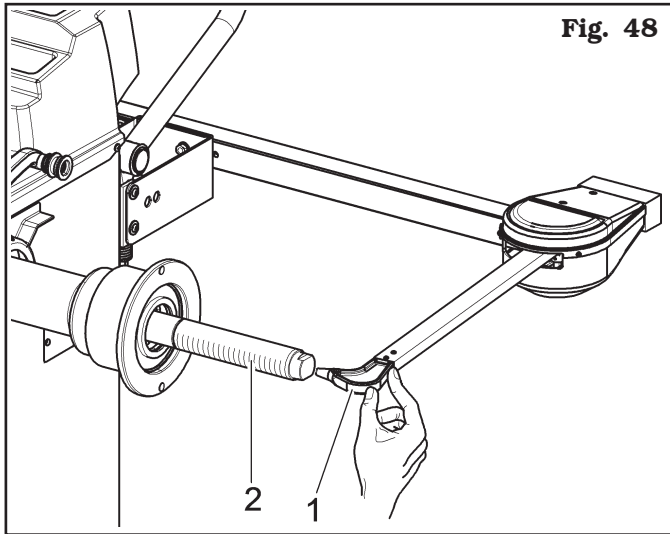
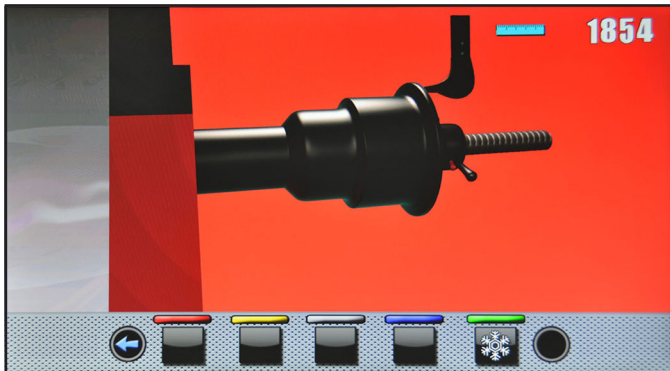

Fig. 48



Press button

On the monitor the next screen page will be displayed:



Move the tip of the width measuring device (**Fig. 49 ref. 1**) in line with the outer surface of the flange (**Fig. 49 ref. 2**).

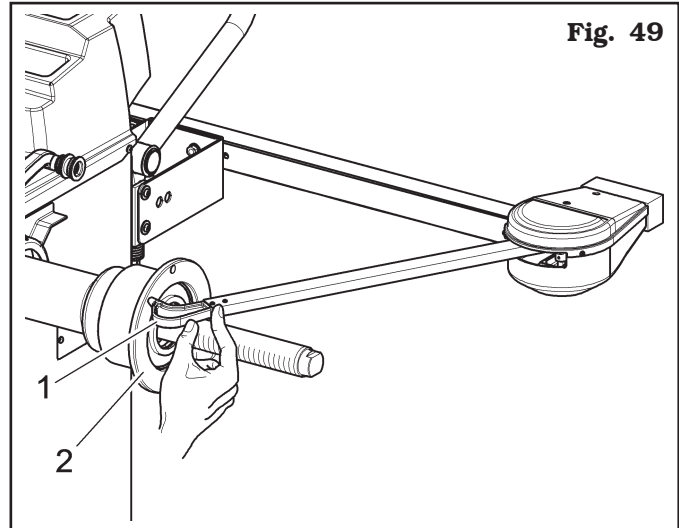
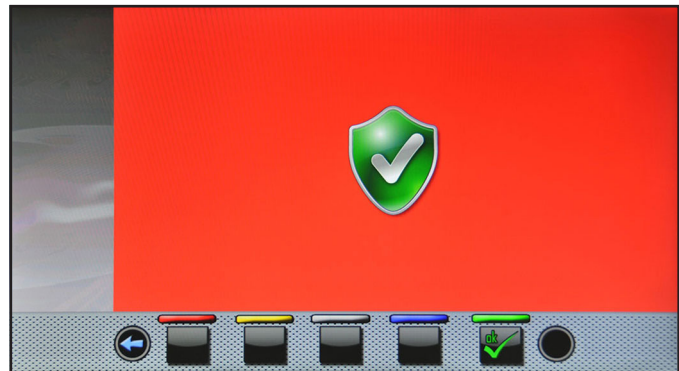

Fig. 49



Press button

At the end of the operation, the following screen will appear on the monitor:



The calibration of the external data gauge is finished.

15.0 ERROR SIGNALS

During wheel balancer operation, if wrong commands are given by the operator or device faults occur, an error code may appear on the monitor screen.

Below is a troubleshooting chart.

Error code	Description
2	Planned wheel speed not reached
3	Calibration overcoming
4	Wheel speed stability out of tolerance
5	Encoder calibration error
6	Encoder samples not sufficient
7	Chuck calibration error
8	Piezo calibration values out of tolerance
9	Wheel rotations not completed
10	Pneumatic chuck open
11	Incorrect gain calibration
12	Distance-diameter caliper value not released
13	Distance-diameter caliper value not released
14	Firmware error
15	Runout samples not sufficient
17	External data gauge enabled
27	Rotate the wheel to make a complete rotation
28	Piezo calibration error
29	Distance out of tolerance level
31	Distance-diameter caliper released
32	Parameters format incompatible

16.0 ROUTINE MAINTENANCE



BEFORE CARRYING OUT ANY ROUTINE MAINTENANCE OR ADJUSTMENT PROCEDURE, POSITION THE MAIN SWITCH "0", DISCONNECT THE MACHINE FROM THE ELECTRICITY SUPPLY USING THE SOCKET/PLUG COMBINATION AND CHECK THAT ALL MOBILE PARTS ARE AT A STANDSTILL.



BEFORE EXECUTING ANY MAINTENANCE OPERATION, MAKE SURE THERE ARE NO WHEELS LOCKED ONTO THE CHUCK.

To guarantee the efficiency and correct functioning of the machine, it is essential to carry out daily or weekly cleaning and weekly routine maintenance, as described below.

Cleaning and routine maintenance must be conducted by authorized personnel and according to the instructions given below.

- Remove deposits of tyre powder and other waste materials with a vacuum cleaner.

DO NOT BLOW IT WITH COMPRESSED AIR.

- Do not use solvents to clean the pressure regulator.



ANY DAMAGE TO THE MACHINE DEVICES RESULTING FROM THE USE OF LUBRICANTS OTHER THAN THOSE RECOMMENDED IN THIS MANUAL WILL RELEASE THE MANUFACTURER FROM ANY LIABILITY!!

17.0 TECHNICAL DATA

17.1 Technical electrical data

Max. absorbed voltage (W)		100
Power supply	Voltage (V)	110 - 230
	Phases	1
	Frequency (Hz)	50/60
Rotation speed (rev/min)		< 100

17.2 Technical mechanical data

Balancing precision (g)	1
Rim width setting (inches)	1.5 ÷ 22
Rim diameter setting (inches)	10 ÷ 26 (automatic) / 10- 30 (manual)
Cycle time (sec)	6
Sound emission level (dBA)	< 70
Max. wheel weight (kg)	65

Weight (Kg)	120
-------------	-----

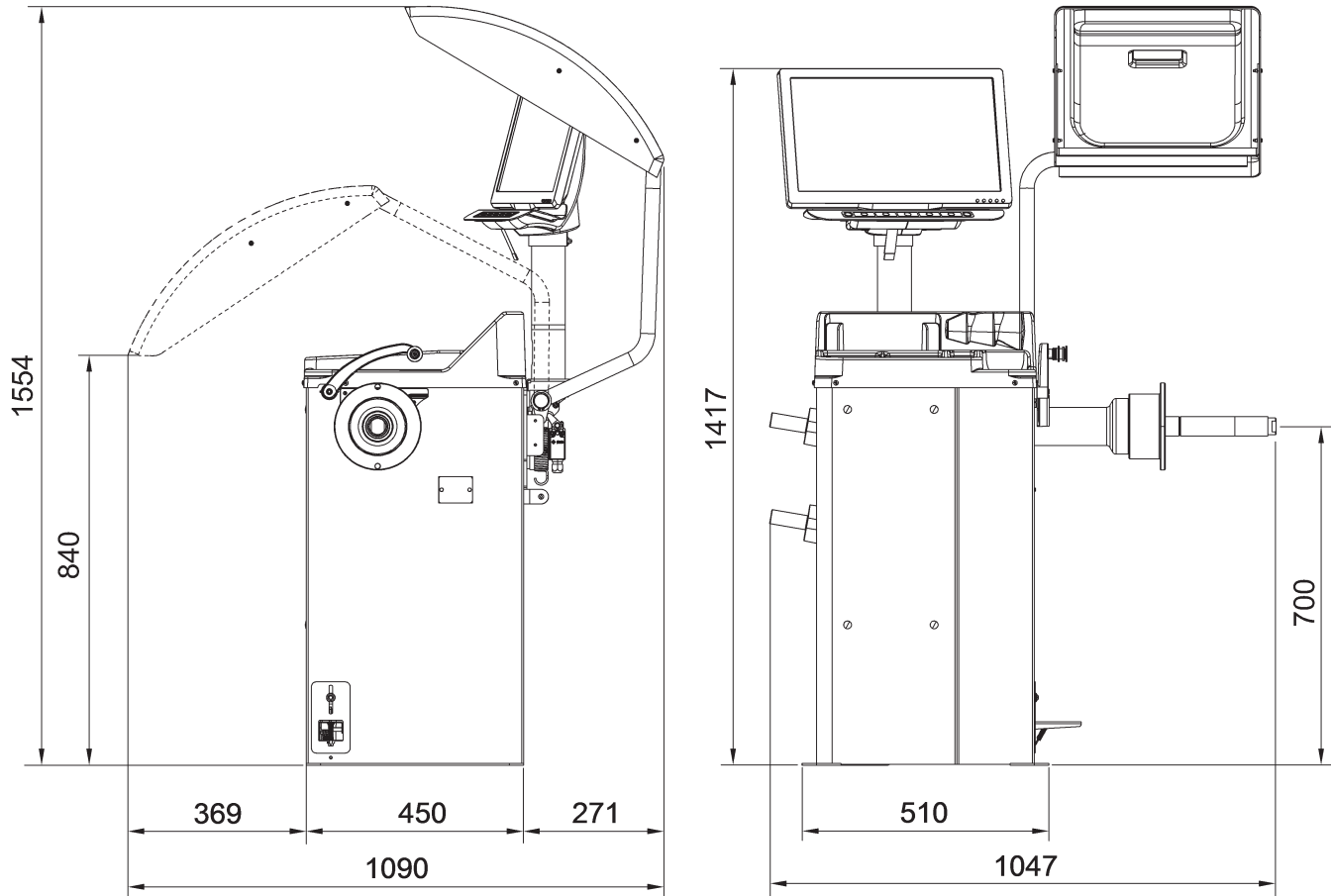
17.3 Dimensions**Fig. 50**

18.0 STORING

If storing for long periods disconnect the main power supply and take measures to protect the machine from dust build-up. Lubricate parts that could be damaged from drying out.

19.0 SCRAPPING

When the decision is taken not to make further use of the machine, it is advisable to make it inoperative by removing the connection pressure hoses. The machine is to be considered as special waste and should be dismantled into homogeneous parts. Dispose of it in accordance with current legislation.

Instructions for the correct management of waste from electric and electronic equipment (WEEE) according to the Italian legislative decree 49/14 and subsequent amendments.

In order to inform the users on the correct way to dispose the product (as required by the article 26, paragraph 1 of the Italian legislative decree 49/14 and subsequent amendments), we communicate what follows: the meaning of the crossed dustbin symbol reported on the equipment indicates that the product must not be thrown among the undifferentiated rubbish (that is to say together with the "mixed urban waste"), but it has to be managed separately, to let the WEEE go through special operations for their reuse or treatment, in order to remove and dispose safely the waste that could be dangerous for the environment and to extract and recycle the raw materials to be reused.

Fig. 51

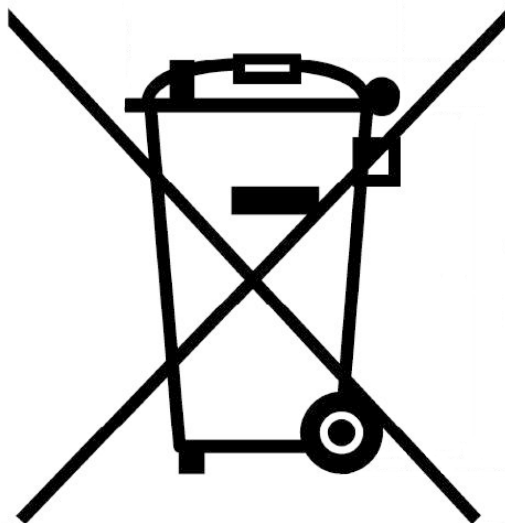

20.0 REGISTRATION PLATE DATA

		SPACE s.r.l. 10090 TRANA (TO) Via Sangano 48 Tel 011-93440300 Fax 011-9338864	
MODEL			
SERIAL N°	YEAR		

The validity of the Conformity Declaration enclosed to this manual is also extended to products and/or devices the machine model object of the Conformity Declaration can be equipped with.



ATTENTION: TAMPERING WITH, CARVING, CHANGING ANYHOW OR EVEN REMOVING MACHINE IDENTIFICATION PLATE IS ABSOLUTELY FORBIDDEN; DO NOT COVER IT WITH TEMPORARY PANELS, ETC., SINCE IT MUST ALWAYS BE VISIBLE.

Said plate must always be kept clean from grease residues or filth generally.

WARNING: Should the plate be accidentally damaged (removed from the machine, damaged or even partially illegible) inform immediately the manufacturer.

21.0 FUNCTIONAL DIAGRAMS

Here follows a list of the machine functional diagrams.

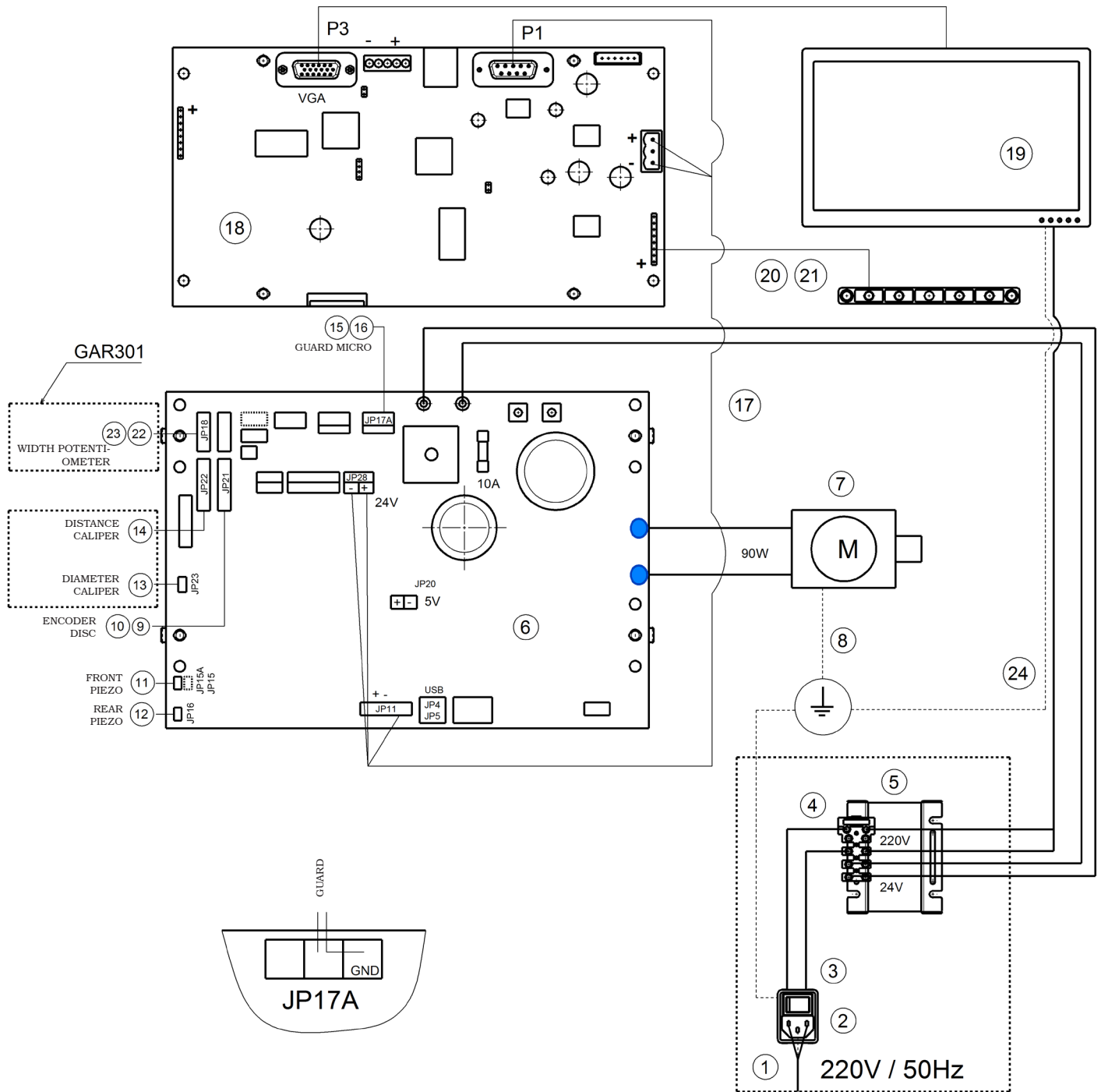

KEY

- | | |
|---|--|
| 1 - Power supply cable | 13 - Potentiometer with cable |
| 2 - Wired switch with plug | 14 - Board |
| 3 - Connection cable from switch to transformer | 15 - Cable for wheel micro protection |
| 4 - Fuse | 16 - Limit switch |
| 5 - Transformer | 17 - Power supply cable |
| 6 - Card kit | 18 - Monitor card kit |
| 7 - Motor | 19 - Monitor |
| 8 - Ground cable | 20 - Keyboard cables |
| 9 - Wheel position sensor cable | 21 - Keyboard |
| 10 - Buffered encoder board | 22 - Width potentiometer extension cable |
| 11 - Piezo with front cable | 23 - Potentiometer with shielded cable |
| 12 - Piezo with rear cable | 24 - Connection cable from transformer to feeder |

ER250R

**WIRING CONNECTION
DIAGRAM**

1296-M022-0_P



Dichiarazione di Conformità

Declaration of Conformity
Konformitätserklärung
Déclaration de Conformité
Declaración de Conformidad



Noi
We / Wir / Nous / Nosotros

SPACE s.r.l.
Via Sangano, 48
10090 TRANA (Torino) - ITALIA

dichiariamo sotto la nostra esclusiva responsabilità che il prodotto

declare, undertaking sole responsibility, that the product
erklären unter unserer alleinigen Verantwortung, dass das Produkt
déclarons, sous notre entière responsabilité, que le produit
declaramos bajo nuestra exclusiva responsabilidad, que el producto

Equilibratrice
Wheel Balancer
Auswuchtmaschine
Équilibreuse de roue
Equilibradora

al quale questa dichiarazione si riferisce, risponde alle seguenti Direttive applicabili:

to which this declaration applies is in compliance with the following applicable Directives:
auf das sich diese Erklärung bezieht, den bestehenden einschlägigen Normen entspricht:
objet de cette déclaration est conforme aux Directives applicables suivantes:
al que se refiere esta declaración cumple con las siguientes Normas aplicables:

2006/42/CE Direttiva Macchine
2014/30/UE Direttiva Compatibilità Elettromagnetica

Per la conformità alle suddette direttive sono state seguite le seguenti Norme Armonizzate:

To comply with the above mentioned Directives, we have followed the following harmonized directives:
In Übereinstimmung mit o.g. Richtlinien wurden folgende harmonisierte Normen befolgt:
Pour la conformité aux normes ci-dessus, nous avons suivi les normes harmonisées suivantes:
Para la conformidad a las Normas arriba mencionadas, hemos seguido las siguientes normas armonizadas:

UNI EN ISO 12100:2010 Sicurezza del macchinario – Principi generali di progettazione – Valutazione del rischio
Valutazione del rischio
CEI EN 60204-1:2006/AC:2010 Sicurezza del macchinario – Equipaggiamento elettrico delle macchine –
Parte 1: Regole generali

La persona preposta a costituire il fascicolo tecnico è SPACE s.r.l..

The technical documentation file is constituted by SPACE s.r.l..
Vorgesetzte Rechtsperson für die Erstellung des technischen Lastenheftes ist SPACE s.r.l.
La société SPACE s.r.l. est l'organisme délégué à la présentation de la documentation technique.
SPACE s.r.l. es encargata a la constitución del archivo técnico.

SPACE s.r.l.