

# WHEEL WASHER REDDY

ART. 3469/230/F

## MANUAL FOR USE AND MAINTENANCE





# SUMMARY

INTRODUCTION .....	4
TECHNICAL DATA.....	5
PREPARING THE MACHINE .....	6
GENERAL SAFETY RULES.....	7
FIRST STARTUP .....	8
OPERATION.....	11
MAINTENANCE.....	15
ALARMS.....	20
TABLE OF FUSES .....	22

# INTRODUCTION

## TAKING DELIVERY OF THE MACHINE

On taking delivery of the machine it is essential to check immediately that you have received all the material listed on the packing list, and that the machine has not been damaged in shipment. If anything is wrong, report the damage at once to the forwarder and inform our customer service office in the meantime. It will be possible to recover any missing material and obtain reimbursement of any damage only if you act promptly and correctly.

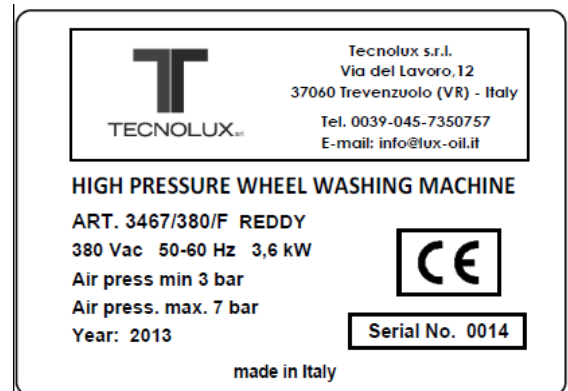

## INTRODUCTION

This is a practical machine for washing automobile wheels complete with rims.

**The machine must only be used for that purpose.**

Even the best of machines will work properly and advantageously only if it is used correctly and kept in good condition. For this reason, we recommend that you read this instruction manual carefully and reread it whenever problems arise while using the machine. In case of need, our service centers, organized in collaboration with our distributors, are always at your disposal for any advice.

**NOTE:** the manufacturer may decide to modify the product without notice in order to adapt it to technological progress and particular production or installation needs. Therefore, even if the illustrations in the manual differ slightly from your machine, the safety devices and instructions are guaranteed.

# TECHNICAL DATA

WIDTH	1025 mm
DEPTH	950 mm
HEIGHT	1340 mm
EMPTY WEIGHT	265 kg
MINIMUM WORKING WATER PRESSURE	2 bar
MIN/MAX WORKING AIR PRESSURE	6 bar – 8bar
WATER CONSUMPTION PER CYCLE (STANDAR PROGRAM)	≈ 14 liters
WATER CONSUMPTION PER CYCLE (SHORT PROGRAM)	≈ 8 liters
WORKING PRESSURE OF NOZZLES	100 Bar

MAXIMUM WHEEL HEIGHT WASHABLE	800 mm
MAXIMUM WHEEL WIDTH WASHABLE	340mm
MAXIMUM WHEEL WEIGHT	60 Kg

MODEL	3469/380/F
POWER SUPPLY	230V ~50 HZ
POWER ABSORBED	3600W

**NOTE: THIS MACHINE WASHES ONLY COMPLETE WHEELS, NOT RIMS OR TIRES ALONE**

**MANUALS SUPPLIED WITH THE MACHINE:**

**USER MANUAL (THIS MANUALE), HIGH PRESSURE PUMP MANUAL, DETERGENT DISPENSER PUMP MANUAL (optional), MOTOR INVERTER MANUAL. READ ALL THE MANUALS CAREFULLY BEFORE USING THE MACHINE.**

# PREPARING THE MACHINE

## **INSTALLATION**

To operate the machine, prepare an area with a width and depth of 1500 mm.

The following connections are needed:

- 1 power outlet.
- 1 compressed air connection with drier filter (min 4 bar).
- 1 filtered cold water connection (min. 2bar) or hot water up to 40°C max. It is important not to exceed this temperature to prevent premature wear of the seals and gaskets on the machine system.

**NOTE: OPERATE THE CONNECTION TO THE WATER SUPPLY SYSTEM WITH A WIRE-REINFORCED HOSE WITH MINIMAL INTERNAL DIAMETER 19 mm AND MAXIMUM LENGTH 5 meters.**

Connection with a hose suitable for draining the wash water.

**NOTE: THE TWO CONNECTORS FOR THE COMPRESSED AIR (min. 4 bar) AND WATER (min. 2 bar) MUST BE ADEQUATELY FILTERED TO REMOVE ALL IMPURITIES AND PREVENT DAMAGE TO THE MACHINE. IN CASE OF SYSTEMS WITHOUT FILTERS WE STRONGLY RECOMMEND INSTALLING ADEQUATE FILTERS ON THE MACHINE INPUTS FOR THE COMPRESSED AIR AND WATER. FAILURE TO COMPLY WITH THIS RECOMMENDATION WILL INVALIDATE THE WARRANTY ON THE MACHINE.**

Position the machine and use the adjustable feet to ensure a minimum forward tilt to facilitate emptying.



# GENERAL SAFETY RULES

**Follow these recommendations carefully to prevent harm to the operator and damage to the machine.**

- Read the labels on the machine, do not cover them for any reason and replace them immediately if damaged
- The machine must be used exclusively by authorized personnel instructed in its use
- When using the machine make sure there are no other people, especially children, in the vicinity
- Do not stand containers of liquids on the machine
- The storage temperature must be between +5°C and +55°C
- The ideal working temperature should be between +5°C and +45°C
- Relative humidity should be between 0 and 80%
- Do not use the machine in an explosive atmosphere.
- **Do not use acid solutions** that could damage the machine and/or people. Use only the detergents recommended by the manufacturer.
- Before starting the machine, make sure all the access panels to the electrical and hydraulic systems are closed with their screws and that all the doors are closed and locked.
- Before performing any work on the inside of the machine, switch it off and disconnect it from the mains.
- Clean the inside of the machine thoroughly every time you clean the tanks.
- If you notice any malfunctions, contact your retailer or send the machine to the nearest service center.
- If you have to replace any parts, order **ORIGINAL** replacements from a concessionaire and/or authorized dealer.
- **Tampering with any part of the machine will invalidate the warranty**
- 



- **CAUTION:** the chemical detergent product supplied with the machine is corrosive for the hands and for the machine. Wear protective gloves to avoid splashing the outer surface of the machine. If you should accidentally spill the product, first unplug the machine, then clean it immediately with plenty of water, without wetting the electric parts and motors.

# FIRST STARTUP

**IMPORTANT! THE FOLLOWING OPERATIONS MUST BE PERFORMED BY QUALIFIED, SPECIALIZED MAINTENANCE PERSONNEL ONLY.**

## CONNECTIONS

- Open the lateral panel (engine/pump side)
- Connect the compressed air as shown in the figure
- Connect the water connector B shown in the picture to the water supply
- Open the panel on the bottom front of the machine
- Connect drain fitting C on the base of stainless steel tank with suitable pipe and tighten with a metal clamp. Open the drain valve.
- All hoses must arrive to their attacks passing under the structure of the machine so that you can close all panels before putting the machine into operation

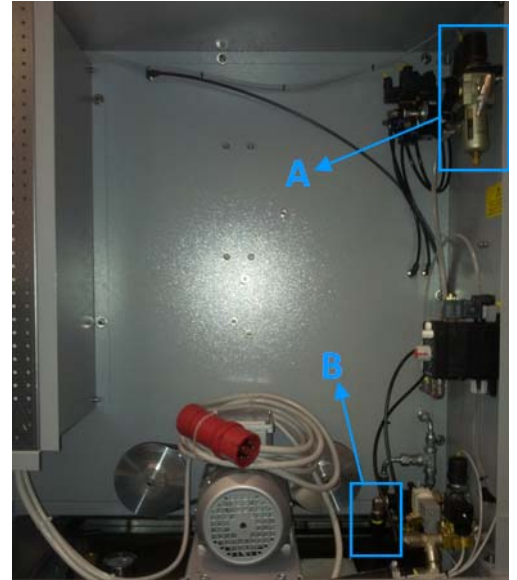



## FIRST STARTUP PROCEDURE



**CAUTION:** always make sure the machine is unplugged before you perform any work on the inside of the machine.

### DETERGENT DISPENSER PUMP

1. Place the detergent tank near to the machine.
2. Enter the two suction pipes of the pump in the tank of detergent indicated in the figure

**CAUTION:** The chemical undiluted detergent supplied with the machine is corrosive for the hands and for the machine. Refer to the general safety rules.

3. If it is necessary to insert the detergent pump, open the upper right side panel, locate the dispenser block, and proceed as follows:  
Turn the adjustment knob to 100 % via the **A** (press and rotate together) completely unscrew the ring **B** (not removing ) Press about ten times the **P** button until you will see the chemical fill the dip tube and then get to the pump.  
Screw the ring **B**, press the **P** button a few times to send the detergent to the nozzles. Replace the adjustment to 60 % using knob **A**.
4. Check that the dispenser regulator is positioned at the indicated value of 60%. This value corresponds to a consumption of 15 grams of detergent for each normal washing cycle . Different settings of the controller may cause excessive consumption of the product and / or unsatisfactory cleaning performance. Close the side panel once the adjustments of the dispenser have been completed.
5. Verify that there are no water leaks. In case of leakage, do not switch on the machine and call for repair.
6. Close the side panel once completed regulation and control operations.

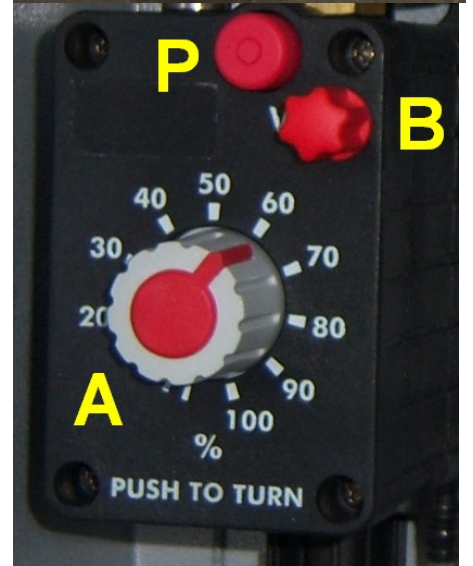

7. Connect the power cord to the wall outlet.

8. Turn on the machine by pressing the frontal switch.



**CAUTION:** Do not switch on the machine with the side panel open . Risk of injury from moving parts .

# OPERATION

**NOTE 1:**

if the orange light is on, it means the safety system has been tripped; see the *alarm section*.



## DESCRIPTION OF THE CONTROLS ON THE FRONT PANEL

**SHORT PROG. key**

The machine performs the short washing cycle. With this program the washing cycle takes about 80 seconds.

**NORMAL PROG. key**

The machine performs the normal washing cycle. With this program the washing cycle takes about 120 seconds.



### MACHINE RINSE key

The machine performs a final rinse cycle without detergent, which takes about 30sec, to rinse the inside walls of the washing compartment of any washing residues, to be performed on empty at the end of the day,



### STOP key

Stops the machine at any time.



### ALARM indicator light

When it is on, it means that the machine's safety systems have been tripped: check the alarm section for detailed information.



# OPERATION

## Introducing the wheel to be washed

Open the door until the floor and introduce the wheel as shown in the figure.



**IMPORTANT:** The direction of wheel insertion must be as shown in the figure. If it is inserted the wrong way it may damage both the machine and the wheel!

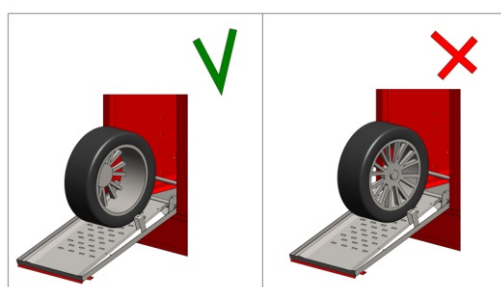

**NOTE:** THIS MACHINE WASHES ONLY COMPLETE WHEELS, NOT RIMS OR TIRES ALONE

**NOTE:** WARNING! DO NOT WASH SPOKE PROTRUDED WHEELS

**NOTE:** THE MACHINE IS EQUIPPED WITH A SAFETY SYSTEM SO THAT IT CANNOT WORK WITH THE DOOR OPEN.

- Press **NORMAL PROG.** or **SHORT PROG.**
- The machine starts the washing cycle.

It will wash the wheel, using high pressure jets of water, to eliminate any mud, loose soil and salt.

- At the end of the cycle, open the door and take the wheel out.



**NOTE:** ALWAYS CLOSE THE DOOR TO ENSURE THAT NOBODY IS INJURED BY BUMPING INTO THE OPEN DOOR.

# OPERATION

**NOTE:** THE MACHINE GIVES NO WARNING ABOUT THE ABSENCE OF CHEMICAL DETERGENT: CHECK PERIODICALLY TO VERIFY THAT THERE IS STILL LIQUID DETERGENT IN THE TANK WHERE THE PIPE OF THE DISPENSER PUMP IS INSERTED.



**NOTE:** IN CASE OF ANY PROBLEM DURING THE WASHING CYCLE, PRESS THE STOP KEY TO STOP THE MACHINE.



**NOTE:** IF THE ORANGE LIGHT IS ON AND THE MACHINE DOES NOT START, SEE THE ALAR, SECTION TO RESOLVE THE PROBLEM



**NOTE 2:** IF THE ORANGE LIGHT IS BLINKING, IT MEANS THE MACHINE REQUIRES MAINTENANCE CHANGE THE OIL IN THE HIGH PRESSURE PUMP, OR CALL THE SERVICE DEPARTMENT TO PERFORM MAINTENANCE. SEE MAINTENANCE SECTION.



# MAINTENANCE

## EMPTYING THE WATER FROM THE TANKS



**NOTE:** BEFORE PERFORMING ANY WORK ON THE MACHINE, UNPLUG IT AND DISCONNECT ALL THE UTILITIES.

**NOTE:** THE MACHINE DOES NOT WARN YOU WHEN THE RECOVER TANKS NEED CLEANING. CHECK THE TANKS FOR CLOGGING PERIODICALLY BY OPENING THE REAR PANEL. CHECK THIS AT LEAST ONCE EVERY 3 MONTHS OR 1000 CYCLES.

Before emptying the water accumulated in the tank, wait 30 minutes so that the impurities can settle. Then open the lower front panel of the machine, remove the retaining screw of the tank. Close the valve and remove the exhaust pipe.

To remove the sludge deposited on the bottom of the tub, remove it from its seat by pulling from the front side and remove the deposits. Clean the inside of the machine thoroughly every time you empty the tank.

Make sure that the pressure regulator(E) drain tube (D) of the pump is inserted into the collection tank. Close the front panel.

**NOTE:** FOR DISPOSAL OF THE WASTE, ALWAYS COMPLY WITH THE LOCAL REGULATIONS.



# MAINTENANCE

## CHANGING THE OIL IN THE HIGH PRESSURE PUMP



**NOTE: BEFORE PERFORMING ANY WORK ON THE MACHINE, UNPLUG IT AND DISCONNECT ALL THE UTILITIES.**

Refer to the specific manual supplied with the high pressure pump for the instructions on how to change the oil, clean the filter and replace the gaskets. **IT IS IMPORTANT TO CHANGE THE OIL FOR THE FIRST TIME AFTER THE FIRST 50 HOURS OF OPERATION OF THE PUMP.** The machine will display with the blinking orange light when the machine needs maintenance. Subsequent oil changes must always be made every 50 hours of operation. The machine will announce the need of maintenance with the blinking orange light. The oil change warning does not stop the machine. It will keep working in any case with the alarm displayed. You should provide as soon as possible to perform the required maintenance.

## REPLACING VERTICAL BUMPERS



**NOTE: BEFORE PERFORMING ANY WORK ON THE MACHINE, UNPLUG IT AND DISCONNECT ALL THE UTILITIES.**

Open the wheel loading door, unscrew the header screws on the top and bottom of the roller column, extract the cylindrical bumper element replace with the new part. Reassemble the bumpers and tighten the screws fully.

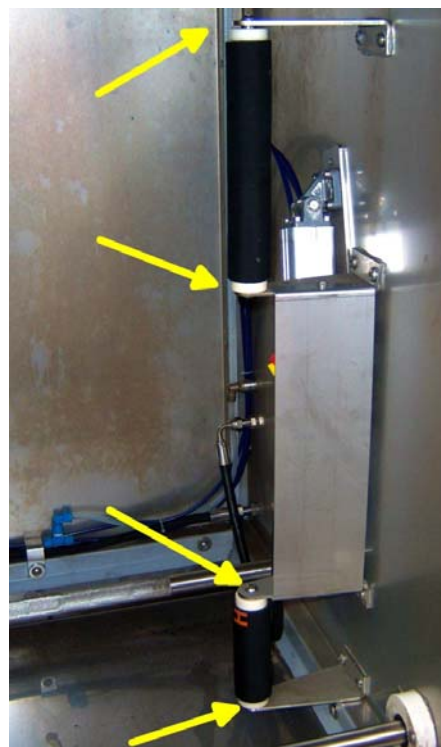



# MAINTENANCE

## REPLACING THE ROLLER ARM



**NOTE:** BEFORE PERFORMING ANY WORK ON THE MACHINE, UNPLUG IT AND DISCONNECT ALL THE UTILITIES.

Open the wheel loading door, unhook the cotter pin from the pipe and partially remove the pipe, sliding the brushes off one by one and replacing them, then reassemble the pipe and cotter pin.



## GREASING BEARINGS ON WHEEL TRACTION SHAFTS



**NOTE:** BEFORE PERFORMING ANY WORK ON THE MACHINE, UNPLUG IT AND DISCONNECT ALL THE UTILITIES.

Open the top right side panel, find the traction shaft bearings and grease the bearings through the grease nipples provided. Close the side panel of the machine.

### Recommended frequency of greasing:

In case of intensive use of the machine, grease the bearings once a month. For limited use of the machine, grease the bearings every 3 months and when changing the oil in the high pressure pump.

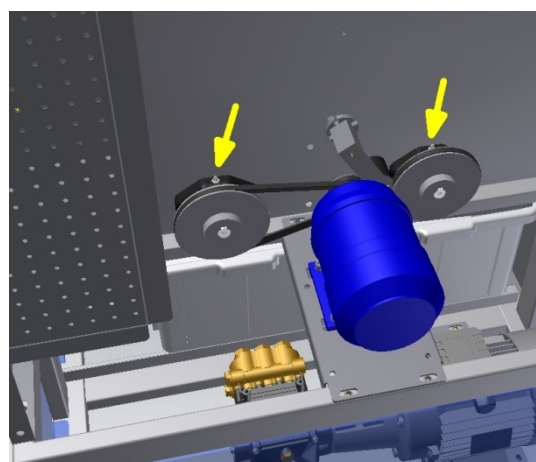

# MAINTENANCE

## CYLINDER STEMS LUBRICATION



**NOTE:** BEFORE PERFORMING ANY WORK ON THE MACHINE, UNPLUG IT AND DISCONNECT ALL THE UTILITIES.

Open the washing compartment, detect the cylinder stems indicated by the arrows in the picture; and oil every point indicated through a lubricant spray.

### Recommended lubrication intervals:

It is recommended to lubricate the stems at least once a week.

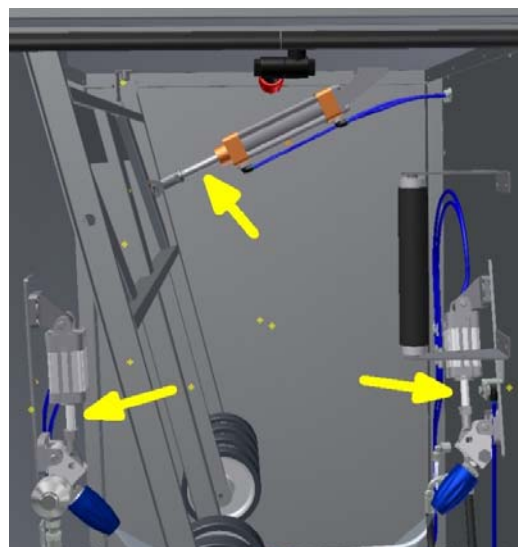

## PUMP OIL REPLACEMENT



**NOTE:** BEFORE PERFORMING ANY WORK ON THE MACHINE, UNPLUG IT AND DISCONNECT ALL THE UTILITIES.

Refer to the manual supplied with specific instructions on how to replace the oil.

**MAKE THE FIRST OIL CHANGE AFTER THE FIRST 50 HOURS OF OPERATION OF THE PUMP AND NEXT CHANGE ALWAYS AFTER 50 HOURS.**

The machine is programmed to warn with an alarm viewable on the display when pump oil replacement is needed. Although the alarm is showed on the display, wheel washer machine can keep on working, but it is necessary to ensure a prompt oil change when the machine shows the alarm.



# MAINTENANCE

## **FUSE REPLACEMENT**

**IMPORTANT! THE FOLLOWING OPERATIONS MUST BE PERFORMED BY QUALIFIED, SPECIALIZED MAINTENANCE PERSONNEL ONLY.**



**NOTE: BEFORE PERFORMING ANY WORK ON THE MACHINE, UNPLUG IT AND DISCONNECT ALL THE UTILITIES.**

If it should be necessary to replace a fuse, open the control panel using the special key provided for access to the electrical system. A mechanical block prevents opening the panel when the main switch is on.

Find the fuse to replace using the wiring diagram and fuse tables in the manual, and replace it one of the same value.

Close the side panel and check that the machine works.



# ALARMS

## ORANGE LIGHT ON

if the orange light is on, it means the safety system has been tripped. Switch off the machine and check the list of possible malfunctions to resolve the problem.



### PROBLEM

### DESCRIPTION

#### NO AIR PRESSURE

The air pressure at the machine input is too low; check that the air is connected to the machine and that the pressure is at least 4 bar

#### NO WATER

The water pressure connected ; check that the water supply is connected to the machine and that the pressure is at least 2 bar

#### DOOR OPEN

The wheel loading door is open; close the door. NOTE: this error causes the orange warning light to light up.

#### INVERTER BLOCK

indicates a problem of excess absorption by the roller motor. Make sure there are no objects jammed in the washing compartment that prevent the movement of the wheel rotation rollers. Make sure the bearings on the wheel rotation rollers are not jammed so as to prevent movement of the rollers.

**MAGNETOTHERMAL SWITCH ON**

Possible abnormal absorption of the high pressure pump motor. Check that the switch inside the electrical panel is on. Refer to the wiring diagram to identify the switch. The pump could be blocked.

**BLINKING ORANGE LIGHT**

WHEN THE ORANGE LIGHT IS BLINKING, IT MEANS THE MACHINE REQUIRES MAINTENANCE.

The machine signals a maintenance alarm every 50 hours of operation of the high pressure pump.

Check the display of the PLC inside the electric compartment. If the outside light is blinking, it signals the "oil change" warning in the high pressure pump.

Consult the specific manual for the pump, which contains instructions for the oil change.

**CHANGE THE OIL IN THE HIGH PRESSURE PUMP OR CONTACT THE SERVICE DEPARTMENT FOR THE NECESSARY MAINTENANCE.**

# TABLE OF FUSES

CODE	TYPE	CHARACTERISTICS
F1	5x20	2 A
F2	5x20	4 A
F3	5x20	3.15 A
F4	5x20	5 A
F5	5x20	10 A
F6	5x20	10 A