

TIRE CHANGER

AUTOMATIC TIRE CHANGER

Kendo.30light Pro Leverless, passenger car, rim diameter: 10" - 30".

Kendo.30light Premium Leverless, including pneumatic bead depressor pusher and pneumatic wheel lift, passenger car, rim diameter: 10" - 30".

+ 10" - 30" leverless tire changer, featuring the patented Butler mounting tool for a stress-free mounting and demounting of all tires and rims (standard, UHP, RunFlat)



Synchronised positioning of the two bead breaker rollers and mounting tool in one movement

User-friendly console

Indent button for correct and safe bead breaking without damaging the tire side wall or the pressure sensor

User-defined speed. Inverter with speed limiter to protect tire

Quick-clamping lock Quick-fit rim clamping device

Quick and safe bead breaking by using two opposite and synchronised rollers disks

Fig. shows: Kendo.30light Premium

Fig. shows: Kendo.30light Pro

HIGHLIGHTS IN DETAIL

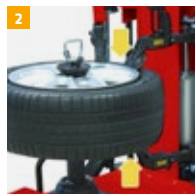
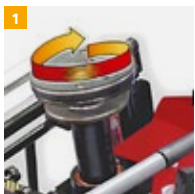

1 Patented extra grip central center post:

Also suitable for reverse rims

Clamping the wheel is quick and requires minimum effort thanks to a self-clamping wheel support the self-locking mechanism of the floating plate

2 Synchronised positioning of the two bead breaker rollers and mounting tool in one movement

Quick and safe bead breaking by using two opposite and synchronised rollers disks

3 Patented mounting head made of scratch-proof material for damage-free work close to the edge of the rim (zero-stress effect)

ACCESSORIES ON REQUEST

- + Universal flange for wheels without centre hole, also suitable for rims with extreme drop centre
- + Bead pusher arm (Kendo.30light PRO)
- + Pneumatic wheel lift (Kendo.30light PRO)

Kendo.30 light Premium

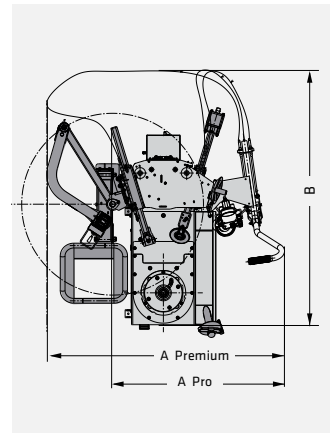
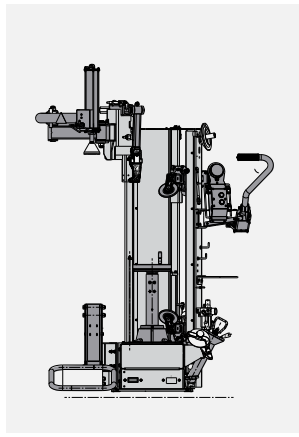
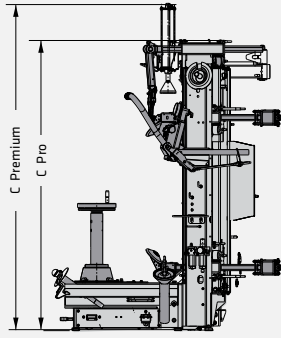

| Model | Kendo.30 light Pro | Kendo.30 light Premium |
|----------------------------------|--------------------|------------------------|
| Clamping range | 10" - 30" | 10" - 30" |
| Rim width max. | 15" | 15" |
| Wheel diameter max. | 1143 mm | 1143 mm |
| Wheel weight max. | 80 kg | 80 kg |
| Automatic bead-breaking movement | Yes | Yes |
| Bead-breaking force | 12 kN | 12 kN |
| Rotation speed | 0-16 rpm | 0-16 rpm |
| Torque max. | 1177 Nm | 1177 Nm |
| Power inverter motor | 1,5 kW | 1,5 kW |
| Motor power | 0,75 kW | 0,75 kW |
| Compressed air supply | 8-10 bar | 8-10 bar |
| Mains frequency | 50 Hz | 50 Hz |
| Mains voltage (AC) | 230 V | 230 V |
| Phases | 1 | 1 |
| Fuse protection | 16 A slow-blow | 16 A slow-blow |
| A Width | 1090 mm | 1490 mm |
| B Depth | 1600 mm | 1600 mm |
| C Height | 1830 mm | 2060 mm |
| Weight | 368 kg | 424 kg |
| Article number (Pro RAL3002) | 812798 | 812800 |
| Article number (Pro RAL7016) | 812799 | 812801 |

SCOPE OF DELIVERY

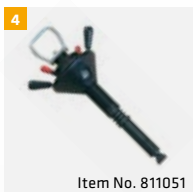
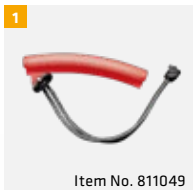

- 1 Rim flange plastic protection
- 2 Magic cord with traction
- 3 Bead protection foils
- 4 Quick-clamping lock
- + Top mounting head for convex rim (811606)
- + WulstBoy with towing device Standard (811443)
- + WDK-Zertifikat (GWDK02033)
- + Only Premium:
Pneumatic bead pusher and wheel lift (811002+811415)