

VL FLEX 52MM SERIES

VL FLEX 52

NMEA 2000

USER MANUAL
rev. AB



EN

DE

IT

FR

ES

PT

CONTENT

- Content.....2**
- Introduction.....3**
 - Package Contents 3
 - The all-in-one Device..... 3
 - Contactless Configuration 3
- Safety Information.....4**
 - Safety During Installation..... 4
 - Safety After Installation..... 5
 - Electrical Connection 5
- Installation6**
 - Before the Assembly 6
 - Mounting with Spinlock Nut.....7
 - Flush Mounting..... 8
- Connections.....9**
 - Pinout 9
 - Wiring Harness..... 9
 - NMEA 2000® Pinout 10
 - Connection to the NMEA 2000® Network..... 10
 - Frequency Input Connection.....11
 - Resistance Sensor Connection11
- Configuration 12**
 - VL Fex Configurator App12
 - Configure Device12
 - Supported Configurations..... 16
- Display Layout 18**
 - Single Layout..... 18
 - Dual Layout..... 18
 - ALARM DISPLAY 19
- Technical Data..... 20**
 - Datasheet..... 20
 - Supported NMEA 2000® PGNs.....21
- Accessories 22**

INTRODUCTION

PACKAGE CONTENTS

Item number	Description
B00043501	1x VL Flex 52
A2C5205947101	1x 52 mm spinlock nut
A2C9582260001	1x wiring harness
B000100	1x safety instructions

THE ALL-IN-ONE DEVICE

The VL Flex 52 can be easily configured as the display device you need thanks to its 1.44" TFT display, readable even in strong sunlight, embedded in a standard 52 mm diameter housing.

Supported analog inputs allow direct reading from motor sensors, and the NMEA 2000® interface extends this function by allowing the VL Flex to read from the digital network.

The simple but effective display layout can be set up in a single or dual layout, presenting the data in a clear and intuitive way, while the colored bar graph and alarm display allow you to interpret the data more quickly.

CONTACTLESS CONFIGURATION

Thanks to contactless configuration, you can configure your all-in-one instrument with a simple "tap"!

Start the smartphone app and define your settings via the user-friendly interface. Then simply hold your smartphone on the front lens of the VL Flex to transfer the configuration immediately.

Thanks to the built-in passive antenna, the configuration can be done without power supply!

SAFETY INFORMATION

WARNING

- No smoking! No open fire or heat sources!
- The product was developed, manufactured and inspected according to the basic safety requirements of EC Guidelines and state-of-the-art technology.
- The instrument is designed for use in grounded vehicles and machines as well as in pleasure boats, including non-classified commercial shipping.
- Use our product only as intended. Use of the product for reasons other than its intended use may lead to personal injury, property damage or environmental damage. Before installation, check the vehicle documentation for vehicle type and any possible special features!
- Use the assembly plan to learn the location of the fuel/hydraulic/compressed air and electrical lines!
- Note possible modifications to the vehicle, which must be considered during installation!
- To prevent personal injury, property damage or environmental damage, basic knowledge of motor vehicle/shipbuilding electronics and mechanics is required.
- Make sure that the engine cannot start unintentionally during installation!
- Modifications or manipulations to veratron products can affect safety. Consequently, you may not modify or manipulate the product!
- When removing/installing seats, covers, etc., ensure that lines are not damaged and plug-in connections are not loosened!
- Note all data from other installed instruments with volatile electronic memories.

SAFETY DURING INSTALLATION

- During installation, ensure that the product's components do not affect or limit vehicle functions. Avoid damaging these components!
- Only install undamaged parts in a vehicle!
- During installation, ensure that the product does not impair the field of vision and that it cannot impact the driver's or passenger's head!
- A specialized technician should install the product. If you install the product yourself, wear appropriate work clothing. Do not wear loose clothing, as it may get caught in moving parts. Protect long hair with a hair net.
- When working on the on-board electronics, do not wear metallic or conductive jewelry such as necklaces, bracelets, rings, etc.
- If work on a running engine is required, exercise extreme caution. Wear only appropriate work clothing as you are at risk of personal injury, resulting from being crushed or burned.
- Before beginning, disconnect the negative terminal on the battery, otherwise you risk a short circuit. If the vehicle is supplied by auxiliary batteries, you must also disconnect the negative terminals on these batteries! Short circuits can cause fires, battery explosions and damages to other electronic systems. Please note that when you disconnect the battery, all volatile electronic memories lose their input values and must be reprogrammed.
- If working on gasoline boat motors, let the motor compartment fan run before beginning work.
- Pay attention to how lines and cable harnesses are laid so that you do not drill or saw through them!
- Do not install the product in the mechanical and electrical airbag area!

SAFETY INFORMATION

- Do not drill holes or ports in load-bearing or stabilizing stays or tie bars!
- When working underneath the vehicle, secure it according to the specifications from the vehicle manufacturer.
- Note the necessary clearance behind the drill hole or port at the installation location. Required mounting depth: 65 mm.
- Drill small ports; enlarge and complete them, if necessary, using taper milling tools, saber saws, keyhole saws or files. Deburr edges. Follow the safety instructions of the tool manufacturer.
- Use only insulated tools, if work is necessary on live parts.
- Use only the multimeter or diode test lamps provided, to measure voltages and currents in the vehicle/machine or boat. Use of conventional test lamps can cause damage to control units or other electronic systems.
- The electrical indicator outputs and cables connected to them must be protected from direct contact and damage. The cables in use must have enough insulation and electric strength and the contact points must be safe from touch.
- Use appropriate measures to also protect the electrically conductive parts on the connected consumer from direct contact. Laying metallic, uninsulated cables and contacts is prohibited.

SAFETY AFTER INSTALLATION

- Connect the ground cable tightly to the negative terminal of the battery.
- Reenter/reprogram the volatile electronic memory values.
- Check all functions.
- Use only clean water to clean the components. Note the Ingress Protection (IP) ratings (IEC 60529).

ELECTRICAL CONNECTION

- Note cable cross-sectional area!
- Reducing the cable cross-sectional area leads to higher current density, which can cause the cable cross-sectional area in question to heat up!
- When installing electrical cables, use the provided cable ducts and harnesses; however, do not run cables parallel to ignition cables or to cables that lead to large electricity consumers.
- Fasten cables with cable ties or adhesive tape. Do not run cables over moving parts. Do not attach cables to the steering column!
- Ensure that cables are not subject to tensile, compressive or shearing forces.
- If cables are run through drill holes, protect them using rubber sleeves or the like.
- Use only one cable stripper to strip the cable. Adjust the stripper so that stranded wires are not damaged or separated.
- Use only a soft soldering process or commercially available crimp connector to solder new cable connections!
- Make crimp connections with cable crimping pliers only. Follow the safety instructions of the tool manufacturer.
- Insulate exposed stranded wires to prevent short circuits.
- Caution: Risk of short circuit if junctions are faulty or cables are damaged.
- Short circuits in the vehicle network can cause fires, battery explosions and damages to other electronic systems. Consequently, all power supply cable connections must be provided with weldable connectors and be sufficiently insulated.
- Ensure ground connections are sound.
- Faulty connections can cause short circuits. Only connect cables according to the electrical wiring diagram.
- If operating the instrument on power supply units, note that the power supply unit must be stabilized and it must comply with the following standard: DIN EN 61000, Parts 6-1 to 6-4.

INSTALLATION

⚠ WARNING

Before beginning, disconnect the negative terminal on the battery, otherwise you risk a short circuit. If the vehicle is supplied by auxiliary batteries, you must also disconnect the negative terminals on these batteries! Short circuits can cause fires, battery explosions and damages to other electronic systems. Please note that when you disconnect the battery, all volatile electronic memories lose their input values and must be reprogrammed.

BEFORE THE ASSEMBLY

1. Before beginning, turn off the ignition and remove the ignition key. If necessary, remove the main circuit switch

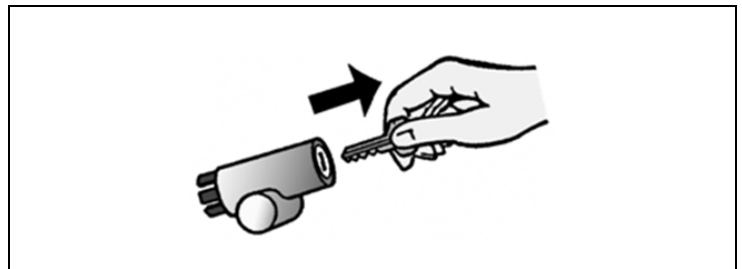

2. Disconnect the negative terminal on the battery. Make sure the battery cannot unintentionally restart.

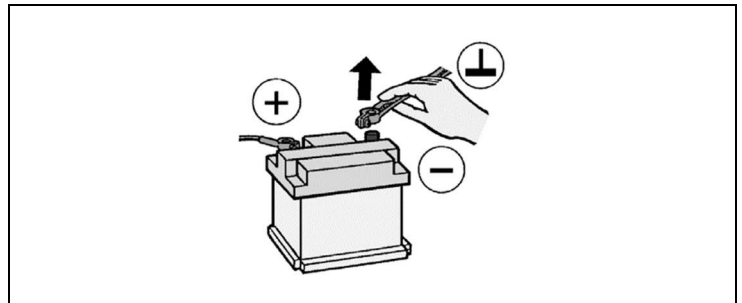

3. Place the device at least 300 mm away from any magnetic compass.

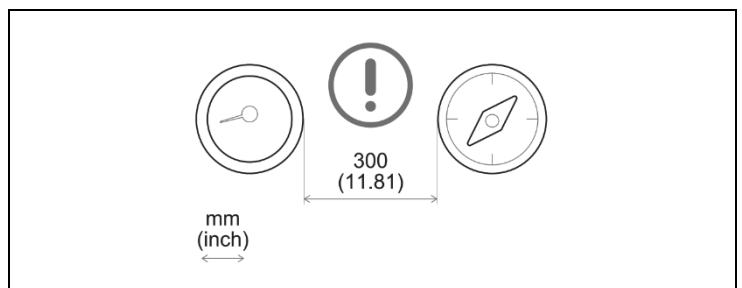

MOUNTING WITH SPINLOCK NUT

Conventional mounting. (Device is inserted into the hole from the front).

The panel thickness can be in the range of 0.5 to 20 mm. The hole must have a diameter of 53 mm [B].

⚠ WARNING

- Do not drill holes and installation openings in load-bearing or stabilizing struts or spars!
- For the installation location, ensure the necessary clearance behind the holes or the installation opening. Required installation depth 65 mm.
- Pre-drill small installation openings, enlarge with cone cutter, hole saw, jigsaw or file if necessary and finish. Deburr edges. Refer to the safety instructions of the hand tool manufacturer.

1. Different covers can be mounted as an alternative to the supplied cover. In this case, carefully remove it with a screwdriver [A], attach the new bezel to the instrument and press it until it is flush with the cover glass.

Note: When removing, the front ring damaged and can no longer be used

IMPORTANT: If you install a chrome bezel, you must set up the device before installation. The metal particles contained in the chrome trim may affect the performance of the wireless interface!

2. Make a round hole, taking into account the external dimensions of the device. [B]
3. Remove the spinlock nut and insert the device frontally. [C]
4. Align the spinlock nut as shown in [D], according to the thickness of the plate.
5. Feed the cables through the spinlock nut and carefully screw it in at least two turns.
6. Connect the plugs.

A

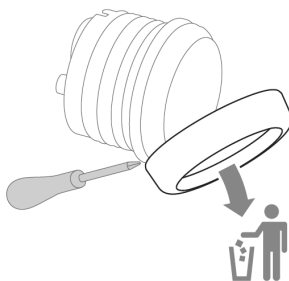

B

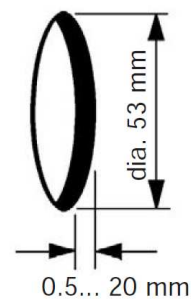

C

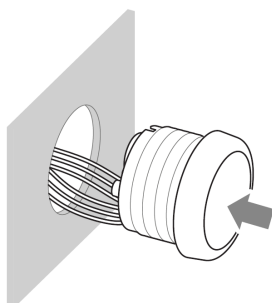

D

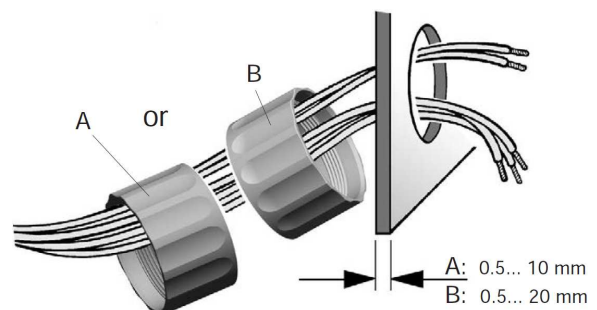

FLUSH MOUNTING

The recommended panel thickness is 1.5 to 3mm. The hole must have a diameter of 48.1mm [A].

Make sure that the installation location is level and has no sharp edges.

⚠ WARNING

- Do not drill holes and installation openings in load-bearing or stabilizing struts or spars!
- For the installation location, ensure the necessary clearance behind the holes or the installation opening. Required installation depth 65 mm.
- Pre-drill small installation openings, enlarge with cone cutter, hole saw, jigsaw or file if necessary and finish. Deburr edges. Refer to the safety instructions of the hand tool manufacturer.

1. Make a round hole, taking into account the external dimensions of the device. [A]
2. Remove the spinlock nut
3. Remove the front ring using a screwdriver. [B]
Note: When removing, the orifice plate will be damaged and can no longer be used.
4. Place the flushmount gasket A2C53215640 (not included) on the cover glass.
5. Insert the device into the hole [C] from behind.
6. Align the unit so that the reading is straight and fix it to the studs [D] attached to the back of the panel using the flushmount mounting bracket A2C59510864 (not included).
7. Connect the plugs.

A

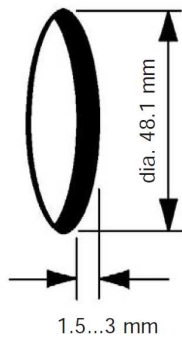

B

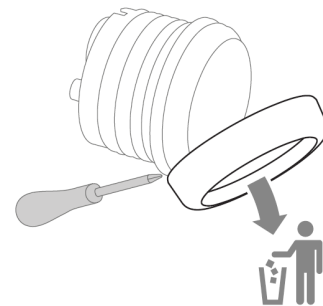

C

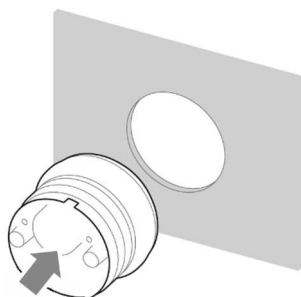

D

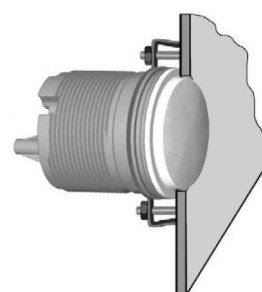

CONNECTIONS

PINOUT

Pin no.	Cable color	Description
1	Red	Term. 15 - Battery 12 / 24 V
2	Black	Term. 31 - Ground
3	Green / Red	Signal - frequency sensor
4	Yellow / Red	Signal - resistance sensor
5	Blue / White	LIN bus
6	Red / White	Illumination day/night
7	-	NMEA 2000 High (on M12 connector)
8	-	NMEA 2000 Low (on M12 connector)

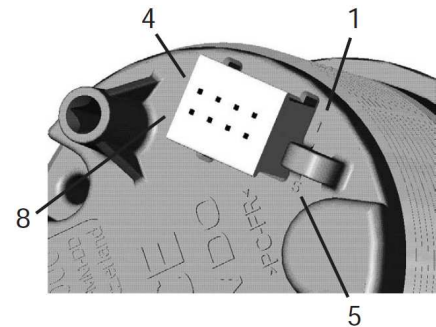

Rear view VL Flex Tyco / Hirschmann 8-poles MQS plug

WIRING HARNESS

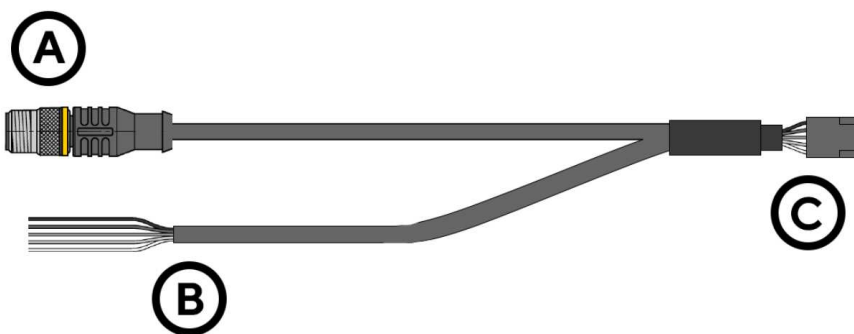

Wiring harness VL Flex

- A: NMEA 2000® DeviceNet M12 5-pin connector
- B: Cables for sensor connection and power supply (see colors in the table)
- C: VL Flex connector - Tyco / Hirschmann MQS 8-pin

NMEA 2000® PINOUT

Pin no.	Description
1	Shielding
2	NET-S (V+)
3	NET-C (V-)
4	NET-H (CAN H)
5	NET-L (CAN L)

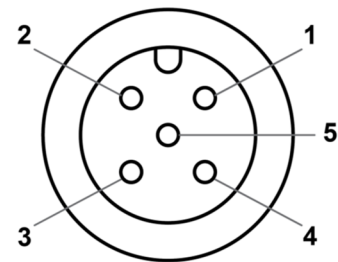

Micro-C M12 5-pin connector
Male, Cable View

CONNECTION TO THE NMEA 2000® NETWORK

Once mounting is complete, the device can be connected to the NMEA 2000® network via the designated socket on the cabling.

Make sure to screw the plug all the way on. This is the only way to guarantee that the connection is waterproof.

A drop cable is only required if the total length of the supplied cabling is not sufficient to reach the NMEA 2000® backbone. In this case it is possible to extend the cable with one of the additional drop cables.

Note that NMEA 2000® does not allow drop cables longer than 6 meters.

Stick to the NMEA 2000® standard for proper network setup.



FREQUENCY INPUT CONNECTION

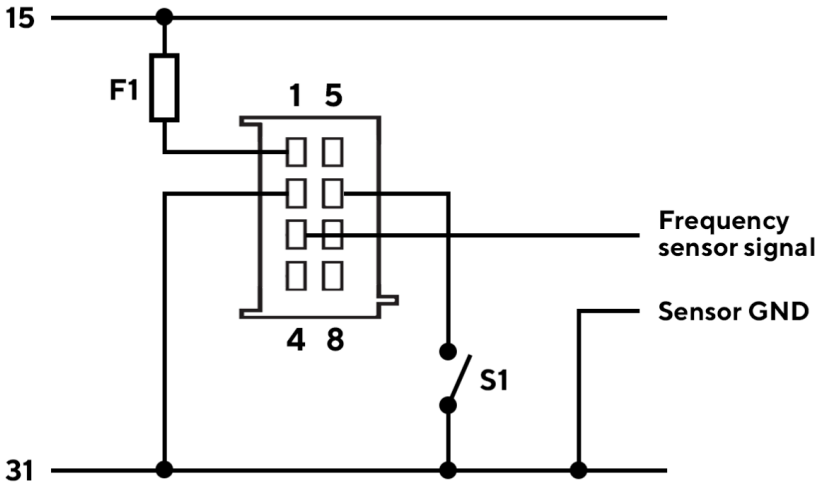

Designations within the connection diagram:

15 - Term. 15 - switched positive 12/24 V (ignition)

31 - Term. 31 - Mass

F1 - Fuse 3A (not included)

S1 - Illumination switch day/night (not included)

RESISTANCE SENSOR CONNECTION

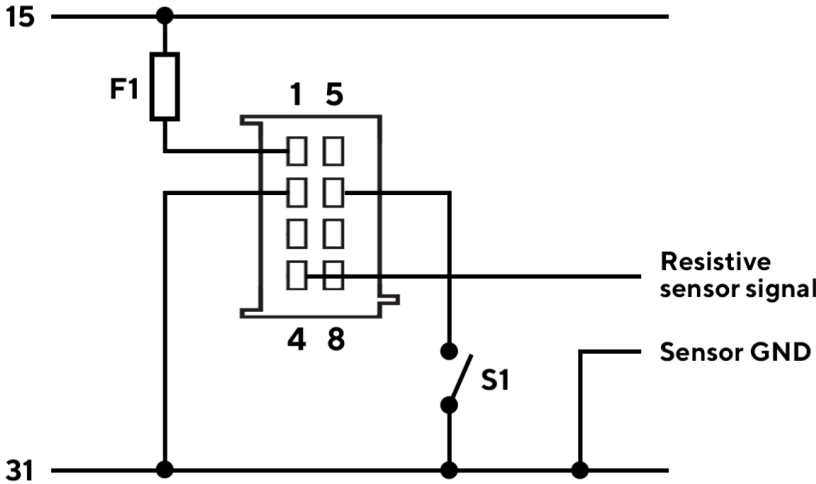

Designations within the connection diagram:

15 - Term. 15 - switched positive 12/24 V (Ignition)

31 - Term. 31 - Mass

F1 - Fuse 3A (not included)

S1 - Illumination switch day/night (not included)

CONFIGURATION

VL FEX CONFIGURATOR APP

To configure the VL Flex, some parameters have to be configured, e.g. the display type, the connected sensor and its calibration or the alarm threshold.

This is possible via the smartphone app "VL Flex Configurator", which can be downloaded free of charge from the stores for both Android and iOS devices.

You can also find a simple explanation of the setup process as in-app instructions.

Thanks to the passive NFC receiver, the VL Flex device can be configured as described below without the need for a power supply.



VL FLEX CONFIGURATOR



CONFIGURE DEVICE

Setting up the VL Flex device is a three-step process.

Remember that the configuration of the instrument must be read before it can be changed and written to the instrument.

1. READ



2. CONFIGURE



3. WRITE



1. READ CONFIGURATION

Open the "VL Flex Configurator" app and read the current configuration of the device by "touching" the front lens of the device with the smartphone.

The READ operation is mandatory before the WRITE operation is allowed.

After reading, the app is set with the current configuration of the VL Flex.



Note: The position of the antenna on the smartphone depends on the model. For more information, refer to the smartphone manufacturer's manual.

2. SELECT DISPLAY LAYOUT

Use the Layout section to choose between single and double image layouts.

The preview image at the top of the app screen will update accordingly.

When Dual Layout is selected, the app expands the device settings to be able to configure both fields of the screen.

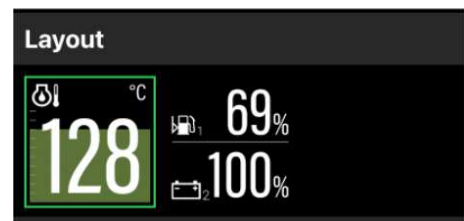

3. SELECT DISPLAY TYPE

Use the Gauge Type item in the Data Selection section to select the data to be displayed on the VL Flex.

If the dual layout is selected, you can select the data for the upper as well as for the lower part of the screen separately.

Note: For the complete list of supported data types, see the Supported Configurations table in this document.

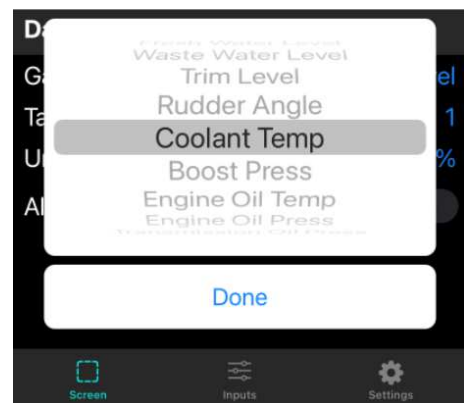

4. SELECT MASS UNITS AND INSTANCE

CONFIGURATION

Define the unit of measurement for the displayed data. (see table "Supported configurations").

Set the instance for the displayed data (e.g. engine number or tank number) so that they are shown correctly on the display.

Some rudder position sensors send their data on their own instance instead of the associated instance of the engine. In this case, the "Ignore" option must be selected as the Engine Instance.

Note: The defined instance is also used by the VL Flex when receiving data from NMEA 2000®.

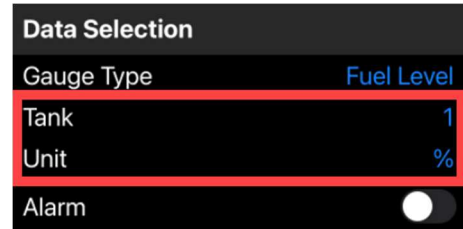

5. ALARM SETTINGS

For some data types an alarm can be set (see table "Supported configurations").

The alarm can be activated or deactivated via the corresponding switch in the app.

Once the option is enabled, the threshold value can be set using the corresponding numeric field. The unit of the alarm threshold is the same unit that was defined in the previous step.

Note: The "direction" of the alarm threshold (up or down) is predefined (see table "Supported configurations").

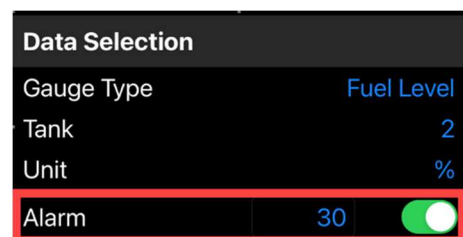

6. CALIBRATE SENSOR

By default, the VL Flex assumes that data is received via NMEA 2000®, so the analog inputs are disabled.

If a sensor is connected via an analog connection (resistance or frequency), it can be configured by activating the corresponding switch in the app.

Note: Depending on the type of display configured, only one of the available inputs can be assigned to the data type. (see table "Supported configurations")

If a dual layout (two values) has been selected, you can select which data is to be configured as an analog input.

The other data is considered to be received from the NMEA 2000® network.

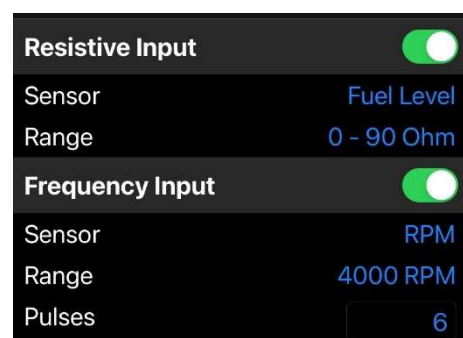

7. LIGHTING AND CLOCK

You can complete the configuration of the VL Flex via the "Settings" tab.

In this section you can set the intensity of the backlight during the day and night using the slider.

This screen can also be used to adjust the clock settings (format and offset).

Note: The clock is only received via NMEA 2000® from an external GPS receiver. It is not counted internally by the VL Flex.

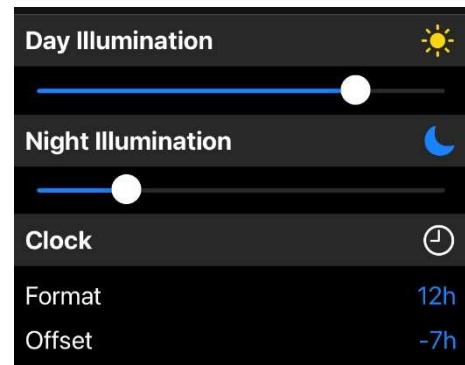

8. TRANSFER CONFIGURATION

Once the configuration is complete, you can download it to VL Flex.

Press the "APPLY" button in the upper right corner of the app and "touch" the front lens of the device with your smartphone.



SUPPORTED CONFIGURATIONS

Display type	Unit	Resistance Sensor	Frequency Sensor	Calibrations	Alarm available	PGN
Tachometer	rpm	-	✓	Pulses per revolution	No	127488
Boat speed	kn km/h mph	-	✓	Pulses per unit	No	128259
Ammeter	A	-	-	-	No	127508
Voltmeter	V	-	-	Measures supply voltage	No	127508
Battery charge	%	-	-	-	Yes (below)	127506
Battery status	%	-	-	-	Yes (below)	127506
Battery temperature	°C °F	-	-	-	Yes (above)	127508
Battery autonomy	h days	-	-	-	No	127506
Operating hours	h	-	✓	Calculated internally	No	127489
Speed Over Ground	kn km/h mph	-	-	-	No	129026
Course Over Ground	deg	-	-	-	No	129026
Depth	m ft	-	-	-	Yes (below)	128267
Fuel level	%	✓	-	0 - 90 Ω 3 - 180 Ω 240 - 33 Ω 90 - 4 Ω 105 - 4 Ω	Yes (below)	127505
Fresh water level	%	✓	-	3 - 180 Ω 240 - 33 Ω 90 - 4 Ω	No	127505
Waste water level	%	✓	-	3 - 180 Ω 240 - 33 Ω 90 - 4 Ω	No	127505

Display type	Unit	Resistance Sensor	Frequency Sensor	Calibrations	CONFIGURATION	
					Alarm available	PGN
Trim	%	✓	-	167 - 10 Ω (Single Station) 84 - 5 Ω (Dual Station)	No	127488
Rudder position	deg	✓	-	10 - 180 Ω (Single Station) 5 - 90 Ω (Dual Station)	No	127245
Cooling water temp.	°C °F	✓	-	291 - 22 Ω (120 °C) 322 - 19 Ω (150 °C)	Yes (above)	127489
Boost pressure	bar PSI	✓	-	10 - 184 Ω (2 bar) 10 - 184 Ω (5 bar)	No	127488
Engine oil pressure	bar PSI	✓	-	10 - 184 Ω (5 bar) 10 - 184 Ω (10 bar)	Yes (below)	127489
Engine oil temp.	°C °F	✓	-	322 - 19 Ω (150 °C)	Yes (above)	127489
Transmission oil pressure	bar PSI	✓	-	10 - 184 Ω (10 bar) 10 - 184 Ω (25 bar) 10 - 211 Ω (30 bar)	Yes (below)	127493
Transmission oil temp.	°C °F	✓	-	322 - 19 Ω (150 °C)	Yes (above)	127493
Clock	-	-	-	-	No	126992

* Supported configurations can be updated at any time. Make sure you always use the latest version of the app.

DISPLAY LAYOUT

SINGLE LAYOUT

A.	<p>Symbol Indicates, which data type is displayed right now.</p> <p>For the data types, which support this function, there is also the instance indicated here.</p>
B.	<p>Unit Shows the unit of the currently displayed data. For some data types it's possible to change the unit in the settings. (See table "Supported Configurations")</p>
C.	<p>Measured value This shows the numeric value of the dedicated measured data. If there aren't any values received for this data type or they are out of range, the display will show "---".</p> <p>Coloured Graph The coloured graphic in the background is a bar diagram that puts the measured value in perspective. This function isn't supported for all data types. The white lines on the left side show the scalation.</p>



DUAL LAYOUT

A.	<p>Symbol Indicates, which data type is displayed right now.</p> <p>For the data types, which support this function, there is also the instance indicated here.</p>
B.	<p>Unit Shows the unit of the currently displayed data. For some data types it's possible to change the unit in the settings. (See table "Supported Configurations")</p>
C.	<p>Measured Value This shows the numeric value of the dedicated measured data. If there aren't any data received for this data type or the values are out of range, the display will show "---".</p> <p>The bar graph can't be displayed in the dual layout for any value.</p>

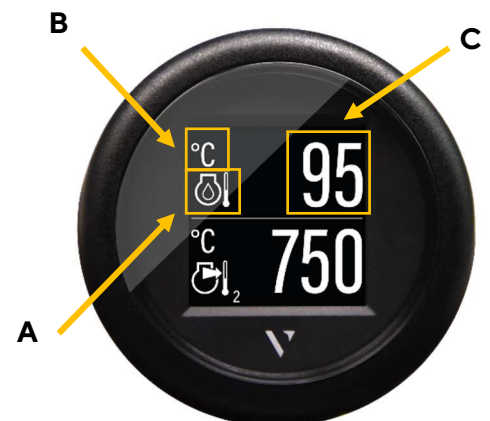

ALARM DISPLAY

**Single data layout**

When an alarm occurs the bar-graph turns red, and a red alarm symbol is displayed in the top part of the display between the data symbol and the unit.

The display returns to normal operation mode once the alarm is not detected anymore.

**Dual data layout**

When an alarm occurs on any of the two displayed data, the numeric digits of the affected data become red.

In the example above, the data at the bottom of the screen (Exhaust Gas Temperature) has an alarm active.

The display returns to normal operation mode once the alarm is not detected anymore.

TECHNICAL DATA

DATASHEET

Screen	1.44-inch TFT color display, sun-readable, transmissive
Screen resolution	125 x 125 Pixel
Rated voltage	12 V / 24 V
Operating voltage	8 - 32 V with overvoltage and reverse polarity protection
Current consumption	50 mA with maximum illumination intensity
Analog inputs	Resistive (0 - 400 Ω) Frequency (W, Ind., Hall, Generator)
Digital inputs	NMEA 2000®, LIN bus
Wireless interface	NFC (Near Field Communication)
Protection class	IP 67 front side (IEC60529)
Cover glass	PMMA with anti-fog and anti-glare coating
Housing	Ø52 mm - Polycarbonate (PC), flame retardant (UL94-V0)
Front ring	PC (black, white) or ABS (chrome); different colors and shapes
Operating temperature	-20°C to +70°C
Storage temperature	-30°C to +80°C
Connection	Tyco / Hirschmann MQS 8-pole
Mounting	Spinlock groove; clamping height 0.5mm - 20mm, Optional bracket and stud bolt, clamping height 2 - 15mm
Standards	CE, Reach, RoHS

SUPPORTED NMEA 2000® PGNS

Description	PGN
ISO Address Claim	60928
ISO Request	59904
ISO Transport Protocol, Data Transfer	60160
ISO Transport Protocol, Connection Management	60416
ISO Acknowledgment	59392
NMEA - Request group function	126208
System Time	126992
Heartbeat	126993
Configuration Information	126998
Product Information	126996
PGN List - Received PGNs group function	126464
Rudder	127245
Fluid level	127505
DC Detailed Status	127506
Battery status	127508
Engine Parameters, Rapid Update	127488
Engine Parameters, Dynamic	127489
Transmission Parameters, Dynamic	127493
Speed, Water Referenced	128259
Water Depth	128267
COG & SOG, Rapid Update	129026

ACCESSORIES

Accessory Part	Part Number
Wiring harness with M12 connector	A2C9582260001
Spinlock nut 52 mm	A2C5205947101
Kit for flush mounting	A2C59510864
Gasket for flush mounting	A2C53215640
Front ring - Round Black	A2C5318602701
Front Ring - Round White	A2C5318602801
Front Ring - Round Chrome*	A2C5318602901
Front ring - Triangular Black	A2C5318602401
Front ring - Triangular White	A2C5318602501
Front ring - Triangular Chrome *	A2C5318602601
Front ring - Flat Black	A2C5318604001
Front Ring - Flat White	A2C5318602201
Front ring - Flat Chrome *	A2C5318602301

Visit <http://www.veratron.com> for the complete list of available accessories.

* The chrome front ring may interfere with NFC programming due to the metal particles contained in the chrome. Make sure that you configure the VL Flex before installing the chrome front ring!



veratron AG
Industriestrasse 18
9464 Rüthi, Switzerland

T +41 71 7679 111
info@veratron.com
veratron.com

Partial or complete distribution, translation or reproduction of this document is strictly prohibited without the prior written consent of veratron AG, with the exception of the following measures:

- Print all or part of the document in its original size.
- Reproduction of the content without modification and explanation by Veratron AG as copyright holder.

Veratron AG reserves the right to make changes or improvements to the related documentation without prior notice.

Requests for approval, additional copies of this manual, or technical information concerning it should be addressed to veratron AG.