

Mont Blanc®

roof bars, boxes,
bike carriers, etc.

MB Bike Carrier TowVoyage Rapid 2

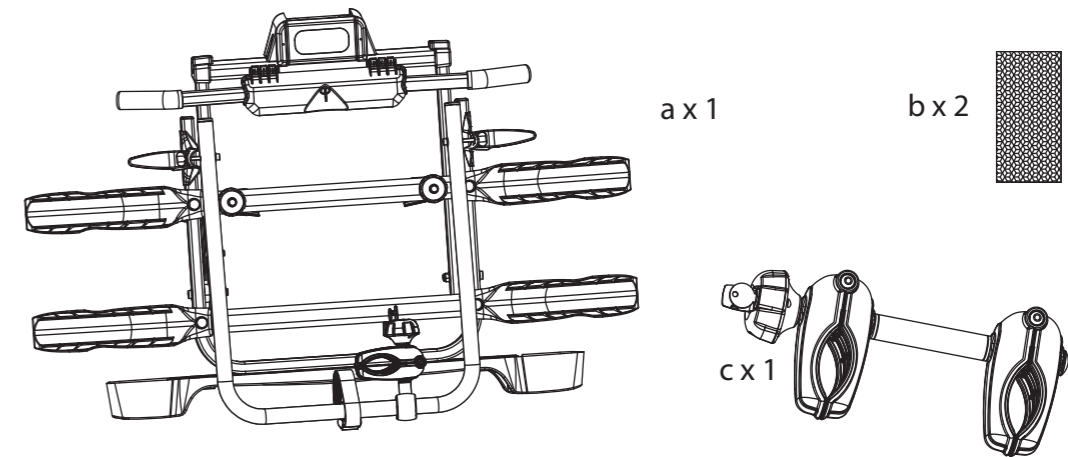

PV 184

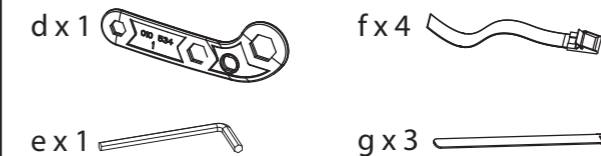

Pour en savoir plus :
www.quefairedemesdechets.fr

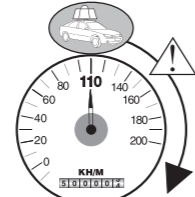
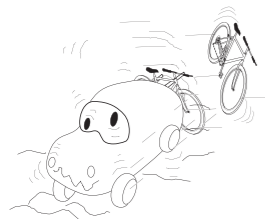
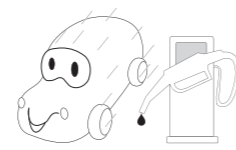
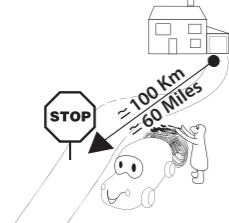
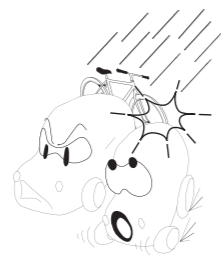
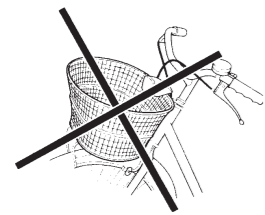

Ø50mm
↓(s) ≥ 60kg

4x4
75mm
45mm

DIRECTIVE 94/20/CE ou REGLEMENT ECER55

x2 = Max. 30 kg

= 13,3 kg



- EN** Keep these instructions for future use.
- FR** Garder cette notice pour les utilisations futures.
- ES** Guardar este manual para futuras utilizations.
- DE** Die Anleitung zur späteren Benutzung aufbewahren.
- IT** Conservare queste istruzioni per ogni ulteriore consultazione.
- NL** Bewaar deze gebruiksaanwijzing voor toekomstige raadpleging.
- PT** Guardar este manual para as utilizações futuras.
- PL** Zachować instrukcję w przypadku użytkowania w przyszłości.
- HU** Őrizze meg ezt a használati utasítást későbbi felhasználás céljából.
- RU** Сохраните эту инструкцию для дальнейшего пользования.
- RO** Păstrați instrucțiunile pentru consultarea lor ulterioară.
- SK** Tento návod si uchovajte pre ďalšie použitie.
- CS** Uchovejte návod pro pozdější použití.
- SV** Behåll denna information för framtida bruk
- BG** Запазете това упътване за бъдещи справки.
- TR** Bu kılavuzu daha sonraki kullanımlar için saklayınız.
- UK** Збережіть цю інструкцію для використання у подальшому.
- EL** Φυλάξτε αυτό το εγχειρίδιο οδηγιών για μελλοντικές χρήσεις.
- DA** Gem denne vejledning til senere brug.
- HR** Sačuvajte ove upute za buduću upotrebu.

Réf. imp. : 058261/B18-1



Mont Blanc France

24-30 rue Claude Bernard - C.S. 61768
35417 Saint Malo Cédex - France
Office : +33 (0)2 99 21 12 70
Fax : +33 (0)2 99 21 12 71

www.montblancgroup.com

