

2

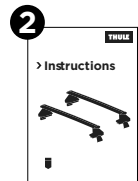

# > Instructions

Thule Evo Clamp  
7105

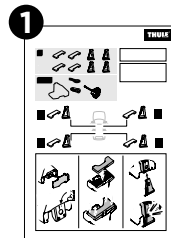
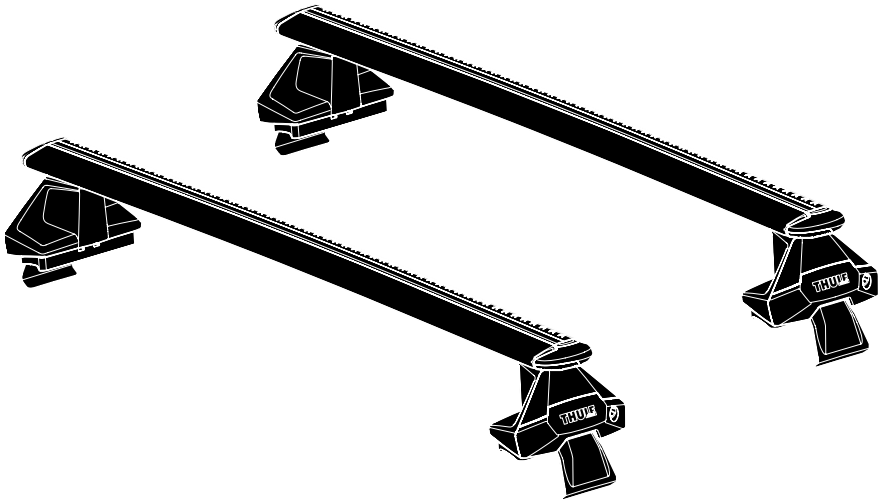

EN Roof mounted load carrier  
 DE Lastenträger zur Dachmontage  
 FR Barre de toit  
 NL Dakdrager  
 IT Barra portatutto da installare sul tetto  
 ES Portaequipajes de techo  
 PT Barra para montagem no tejadilho  
 SV Takmonterad lasthållare  
 DK Tagmonteret lastholder  
 NO Takmontert lasteholder  
 FI Katolle asennettava teline  
 ET Katusele paigaldatav katuseraam  
 LV Uz jumta uzstādāms kravas turētājs  
 LT Ant stogo tvirtinamas krovinijų laikiklis  
 PL Uchwyt na bagażnik bazowy montowany na dachu  
 RU Багажник на крышу  
 UK Багажник для даху  
 BG Багажник, монтиран върху покрива  
 CS Nosič pro montáž na střechu  
 SK Strešný nosič  
 SL Nosilec za strešni prtljažnik

HR/BIH Krovni nosač tereta  
 RO Suport încărcătură montat pe acoperiș  
 HU Tetőre szerelhető csomagszállító  
 EL Σχάρα οροφής για μεταφορά φορτίου  
 TR Araç üstüne bağlanan yük taşıyıcı

HE מנשא מטען לגג הרכב  
 AR حامل نقل مثبت على السقف

ZH 顶置行李架  
 JA ルーフマウント型ロードキャリア  
 KO 루프 장착 화물 캐리어  
 TH โครยัดของบรรทุกแบบติดตั้งบนหลังคา

**CITY CRASH**

Complies with ISO norm

ISO 11154-E

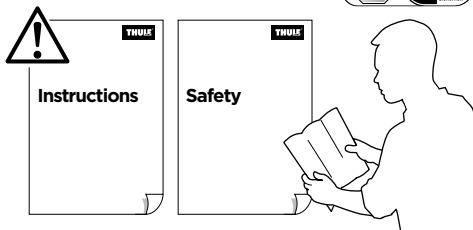

## > Mounting Tutorial

### Thule Evo Clamp

**THULE**  
SWEDEN

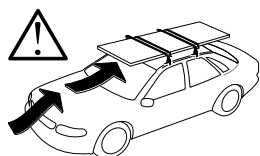

80 km/h  
50 Mph

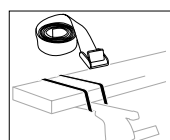
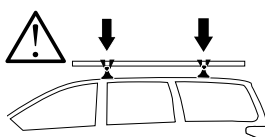
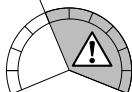

**1**  
KIT

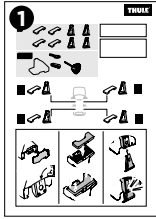

+

**2**  
FOOT PACK

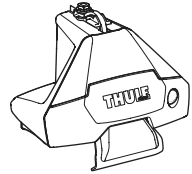
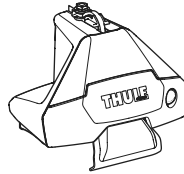
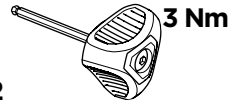
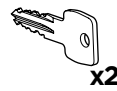
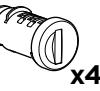
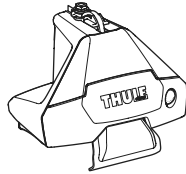
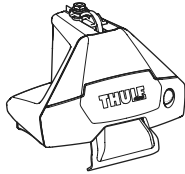
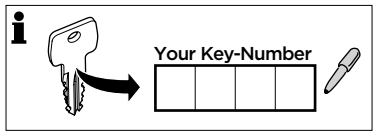
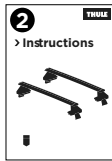

**3**  
BAR



THULE  
WingBar Evo

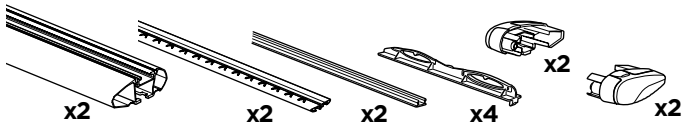

THULE  
WingBar

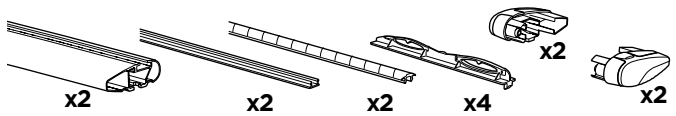

THULE  
SlideBar

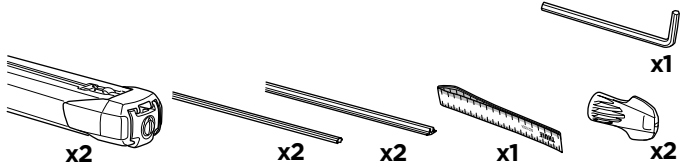

THULE  
ProBar

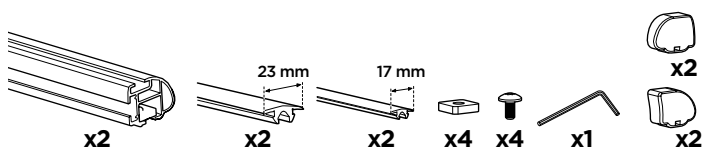

THULE  
SquareBar

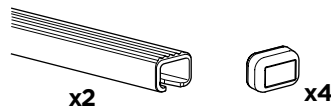

4

BAR

3

THULE  
WingBar Evo

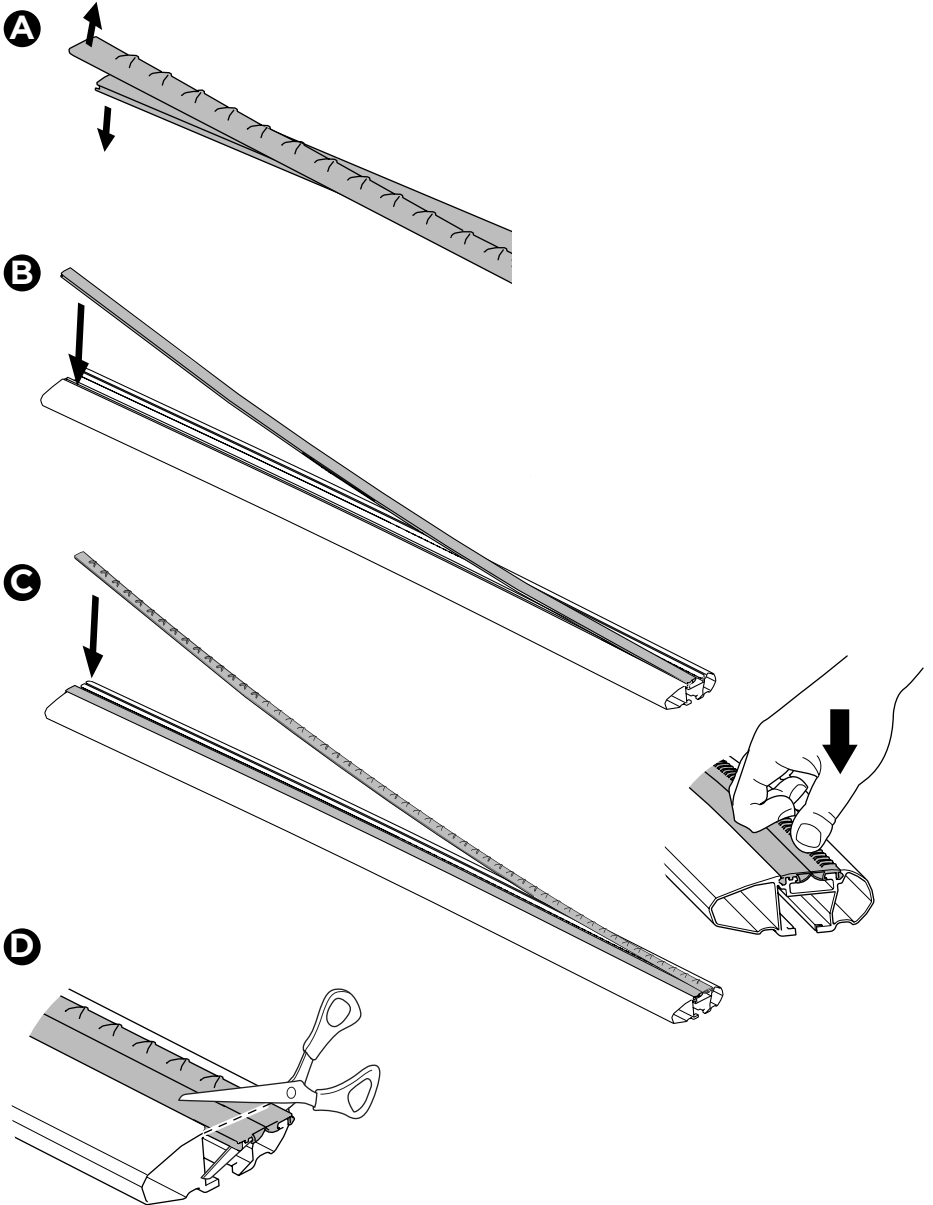

x2

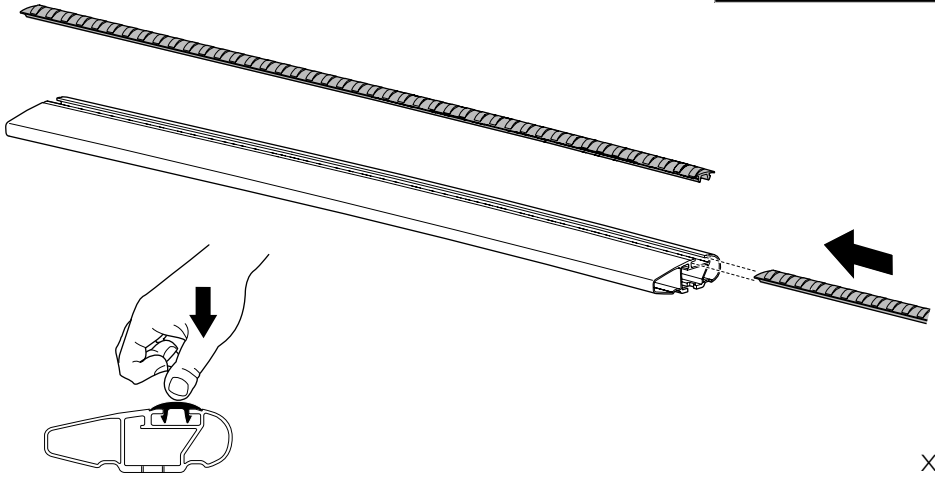

x2

5



A

B

C

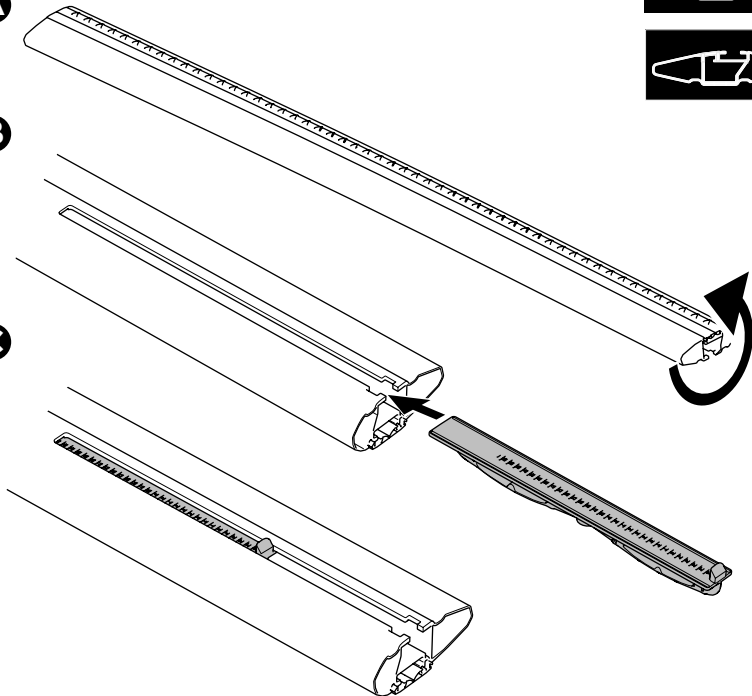

x4

6



+



+

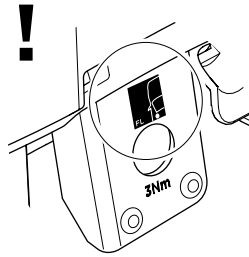
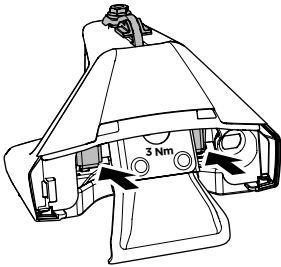

A

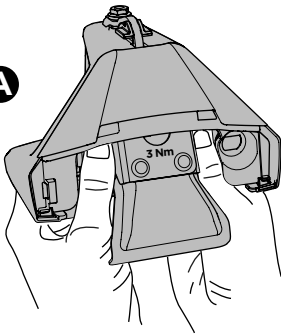

B

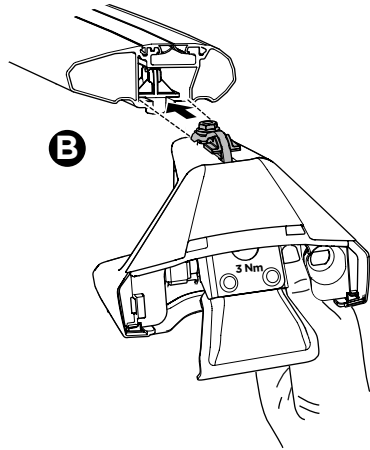

x4

7

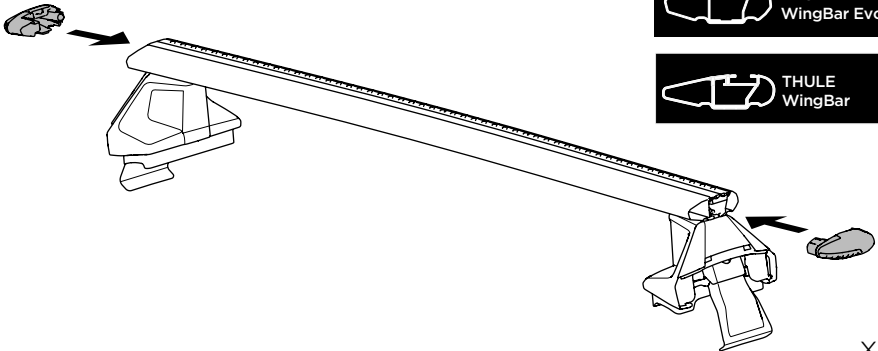

x2

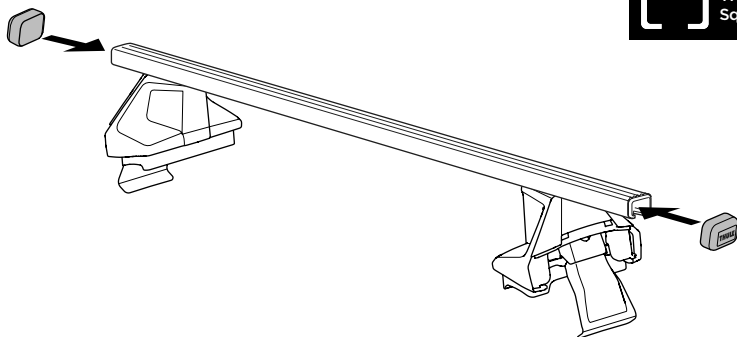

 THULE  
SquareBar

x2

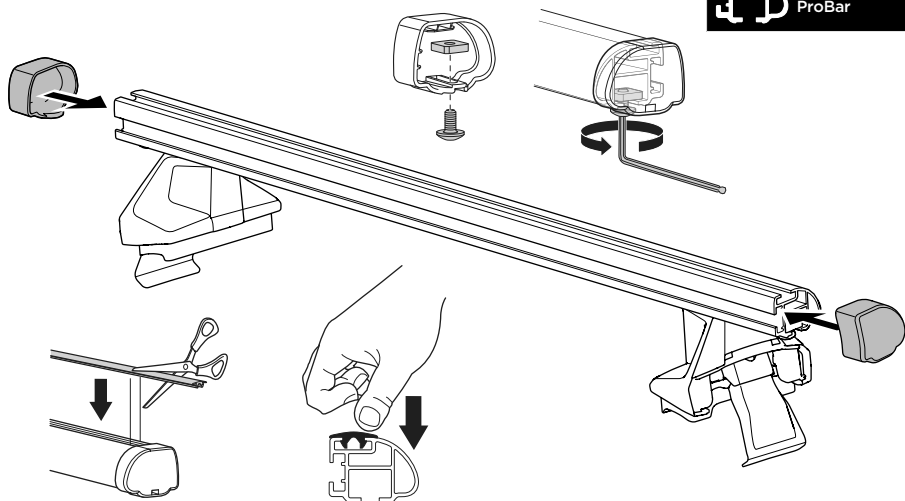

 THULE  
ProBar

x2

 THULE  
SlideBar

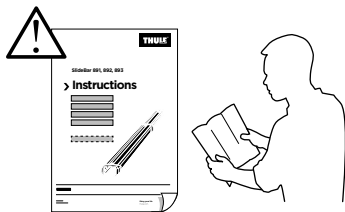
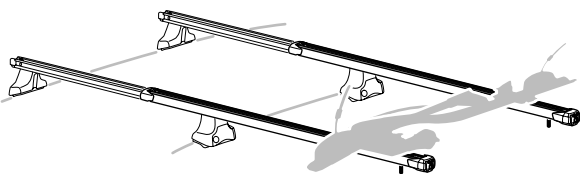

8

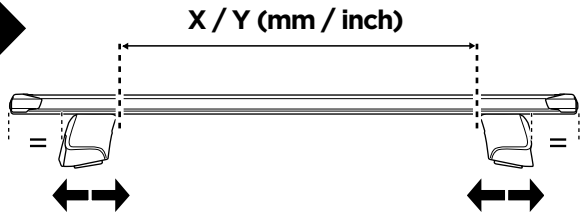
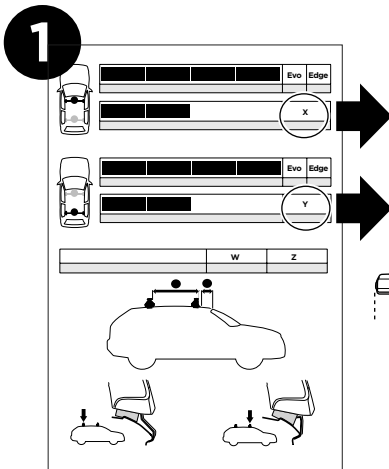
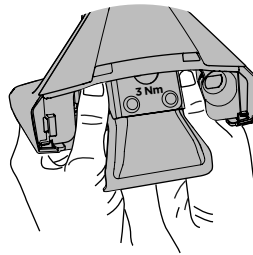
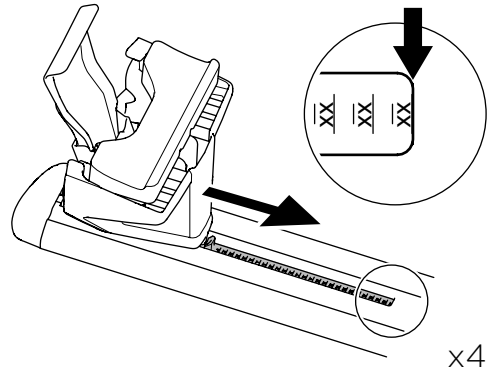
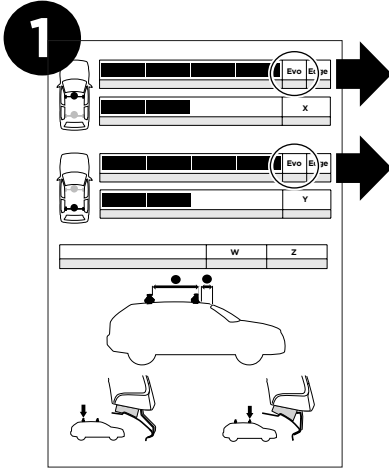
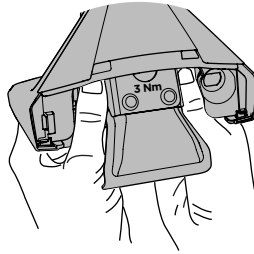



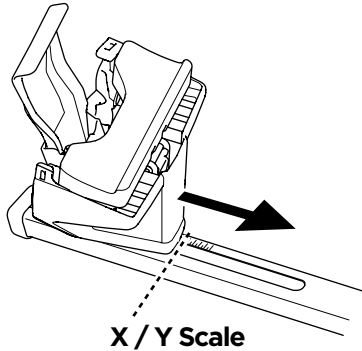
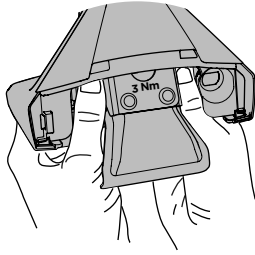
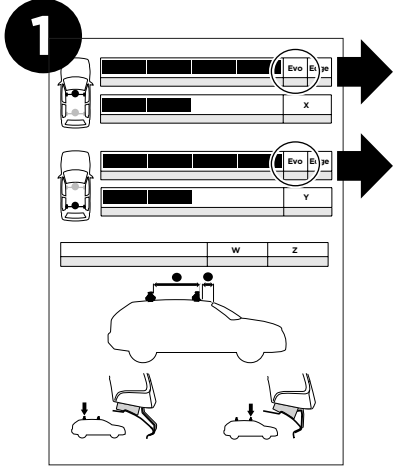

x4

**9**

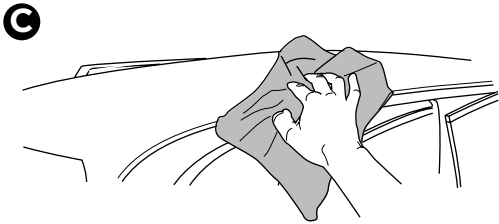
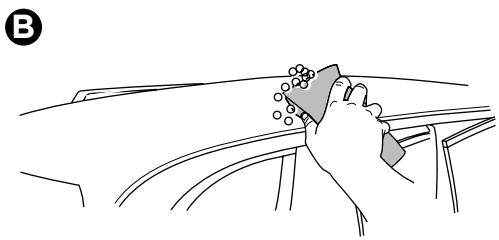
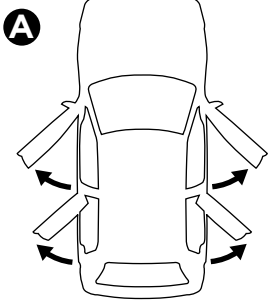

10

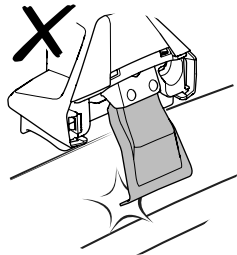
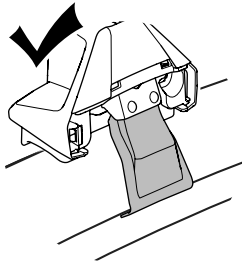
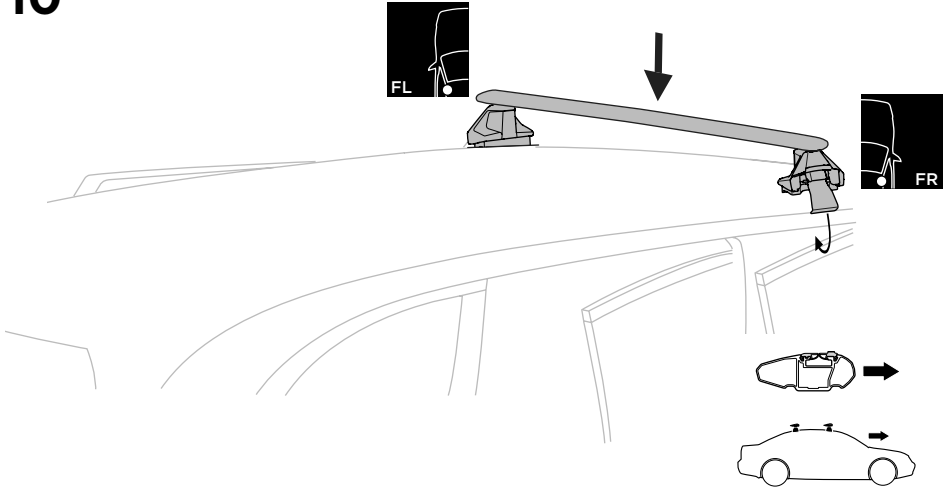

**1**

	Evo Edge
	X

	Evo Edge
	Y

	W	Z
--	---	---



# 11

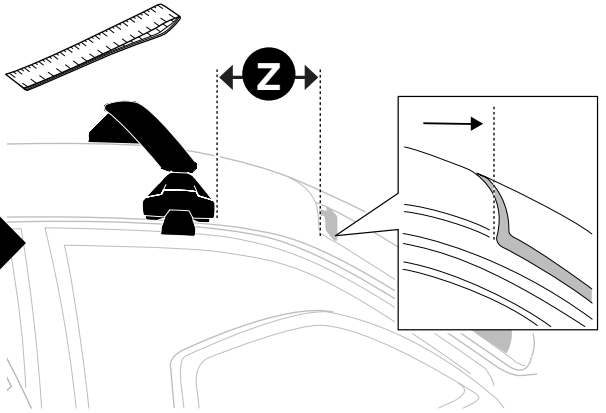

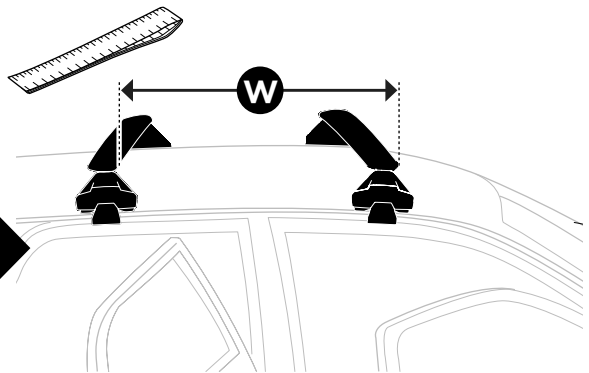
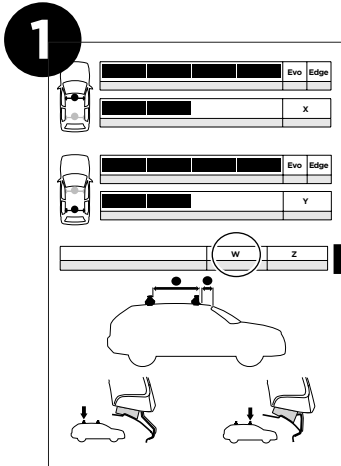
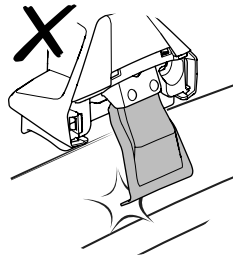
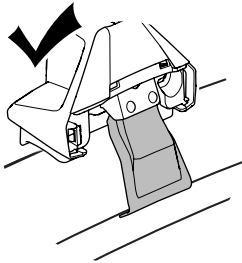
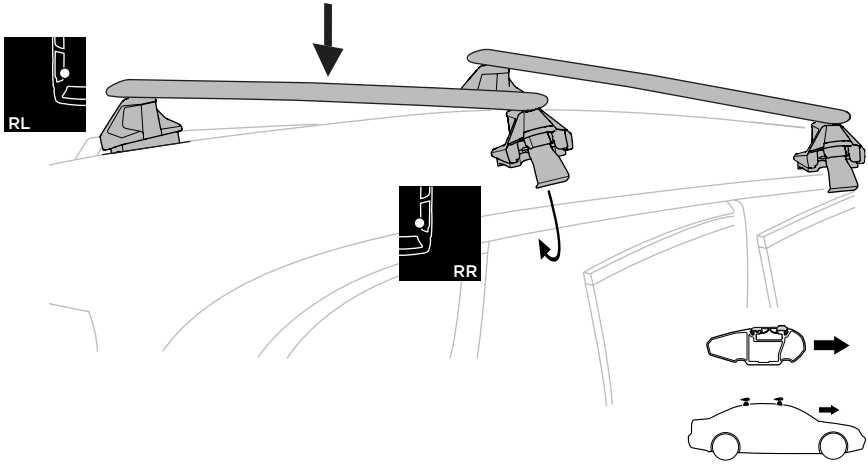
# 12

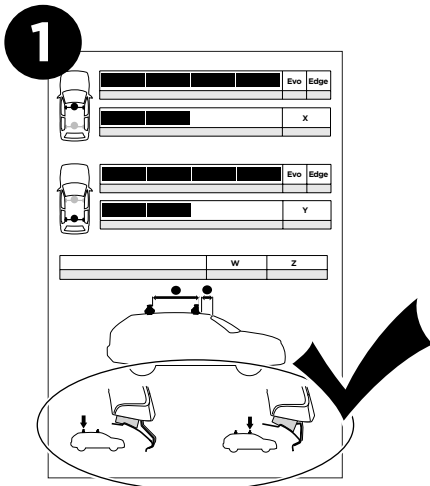
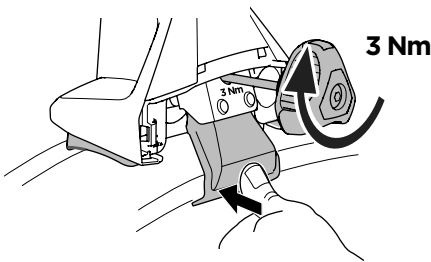
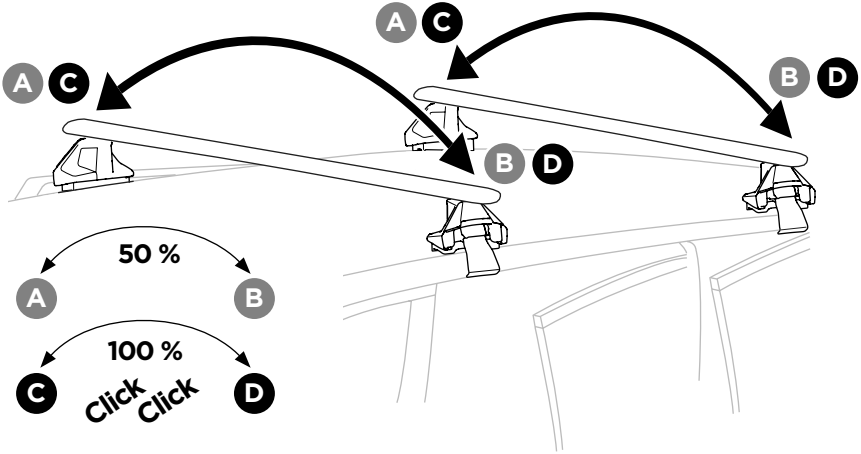

- EN** Tighten alternately
- DE** Die Schrauben abwechselnd anziehen
- FR** Serrer alternativement chaque côté
- NL** Afwisselend aan de linker- en de rechterkant aandraaien
- IT** Alternare il serraggio delle viti
- ES** Apretar alternativamente
- PT** Aperte alternadamente
- SV** Dra åt växelvis
- DK** Spænd skiftevis
- NO** Trekk til vekselvis
- FI** Kierrä vuorotellen
- ET** Pinguldage vaheldumisi
- LV** Pievelciet pamišus
- LT** Užsukinėkite pakaitomis
- PL** Śruby dokręcaj naprzemiennie
- RU** Затягивайте попеременно
- UK** Затягти по чергово
- BG** Затегнете последователно
- CS** Pokręťta багаžníka dokręcaj dokręcaj naprzemiennie.
- SK** Doťahujte striedavo
- SL** Privijajte izmenično
- HR/BiH** Naizmjenično zategnete
- RO** Strângeți alternativ
- HU** Egy mástól függetlenül szorítandó
- EL** Σφιγγετε εναλλάξ
- TR** Dönüşümlü sıkın

إحكام الربط بالتناوب **AR**  
תזק לסירוקן **HE**

- ZH** 交替拧紧
- JA** 左右交互に締めつけてください
- KO** 번갈아 조이기
- TH** ขั้วนินแบบสลับ

13

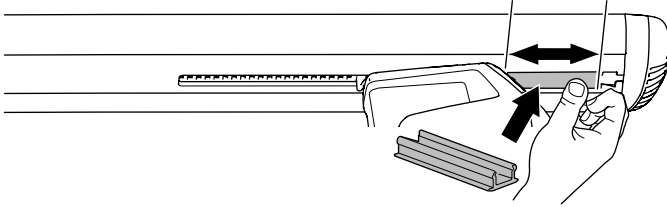
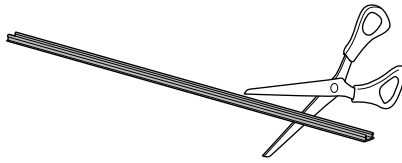

x4

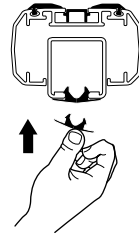
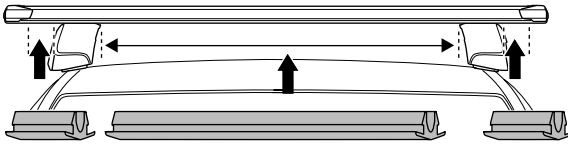
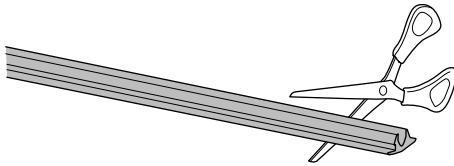

x2

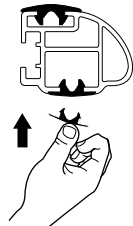
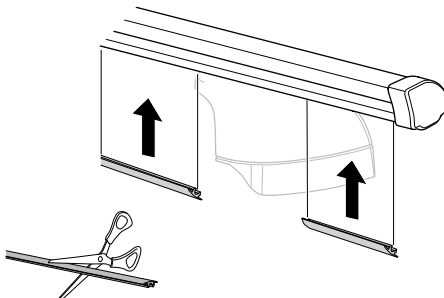
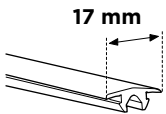

x2

14

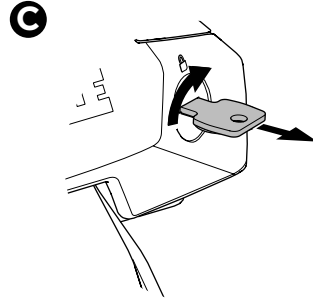
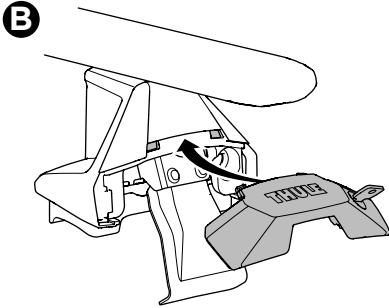
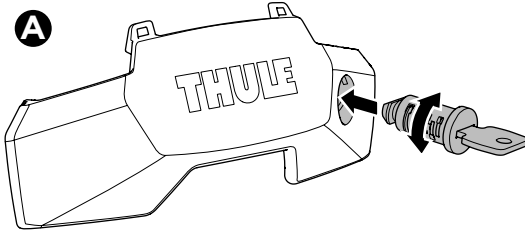

x4

15

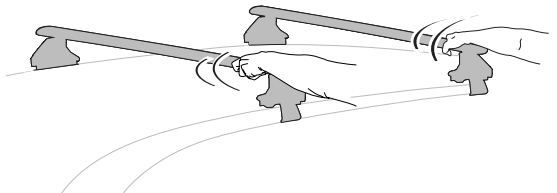
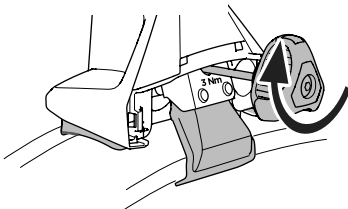
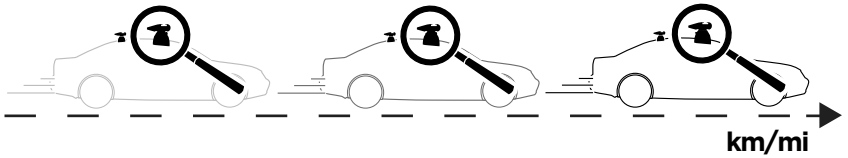
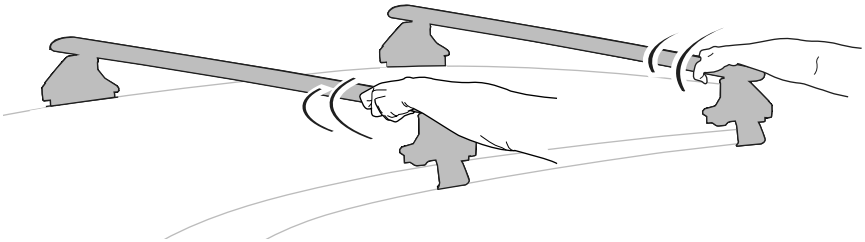

**i**



**THULE**  
WingBar Evo

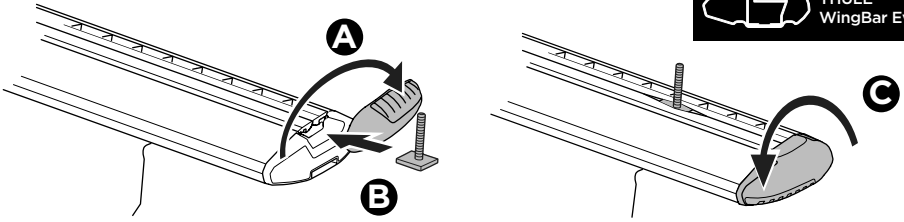

**THULE**  
WingBar

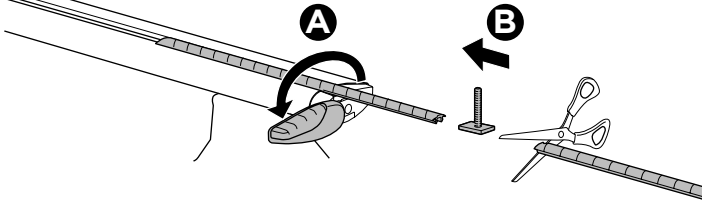

**THULE**  
SlideBar

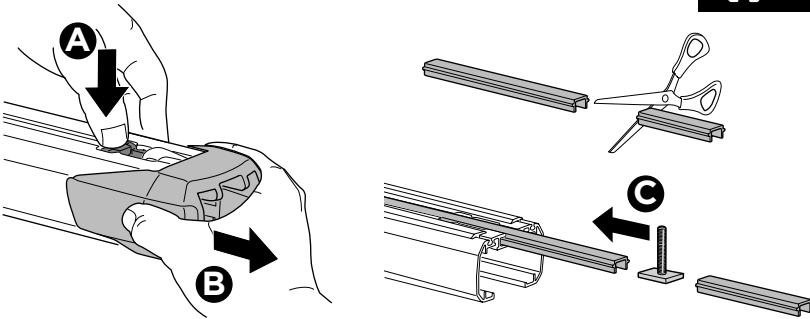

**THULE**  
ProBar

