



HEADLIGHT TESTER

ART. 12509

Manual for Use and Maintenance

rev. 0.0

INDEX

ACCEPTANCE OF THE DEVICE	5
FOREWORD	5
PREPARATION OF THE DEVICE	6
HANDLING CRATED DEVICE	6
CONTENT OF THE PACKAGE	6
WORK SURFACE	8
INSTALLATION.....	8
PREPARATION OF THE VEHICLE	10
WORK SURFACE	10
CONNECTIONS	10
POSITIONING	11
ALIGNMENT WITH THE MIRROR VISOR	11
HEADLIGHT TEST	13
PREPARATION.....	13
SETTINGS	13
HIGH BEAM TEST	15
HEADLIGHT BEAMS WITH INTELLIGENT FUNCTIONS	16
Projectors equipped with Dynamic Light Assist (DLA).....	16
Projector with MATRIX function	18
Projectors with Matrix2 function	21
Light system without glare (ILS).....	24
Projectors with Asymmetric 90° function	26
SUPPLEMENTARY INSTRUCTIONS	29
REPLACEMENT OF LASER VISOR BATTERIES	29
WARRANTY	30

ACCEPTANCE OF THE DEVICE

At the time of delivery it is essential to check at once and

make sure you have received all the material indicated in the shipping documents, and that the device has not undergone damage during shipment. In this case, show the damage to the forwarder and inform our customer service department. Only if you proceed promptly in this way will it be possible to obtain any missing material and reimbursement of the damage.

FOREWORD

This is a device designed for correct beam alignment of any type of automobile or motor vehicle headlight.

The device must be used for this purpose only. Even the finest of devices can function properly and ensure profitable service only if it is used correctly and kept in the best possible condition. For this reason, we ask you to read this manual with care and to reread it whenever difficulties should arise in using the device. In case of need, we remind you that our service centers, organized in cooperation with our retailers, are always at your disposal for any advice you may need.

NOTE: the manufacturer may decide to make changes in the device without notice, in order to adapt it to technological advances and specific production or installation needs. Therefore, even if the illustrations shown in the manual differ slightly from the device in your possession, the safety and instructions about it are guaranteed.

TECHNICAL DATA		
Field of measurement		
orientation: above and below right and left		0 – 600 mm / 10 mt (0 - 6 %) 0 – 1000 mm / 10 mt (0 - 10 %)
Intensity:		0 - 240 lx (Lux/25mt) 0 - 150.000 cd (candles) 0 – 150.000 lx (Lux/1mt)
Unit of intensity measurement		Lux (a 25mt) – Kcand – Klux (a 1 mt)
Unit of orientation measurement		% - cm/10mt – degrees(°)
Height from ground of optical center		from 240 to 1450 mm
Supply voltage with internal battery		12 V
Input voltage of battery charge		100 – 240 V 50/60 Hz
Working temperature		+ 5°C - + 45°C
Width - height - length	mm	660 - 1780 - 695
Weight	Kg	36

PREPARATION OF THE DEVICE

HANDLING CRATED DEVICE

The device is packed in a special crate.

Do not stack more than 3 crates.

The packed weight is 40 kg.

The external dimensions are:

B: 630 mm **L:** 1800 mm **H:** 660 mm

CONTENT OF THE PACKAGE

1 carton containing a base unit

1 column unit

1 visor

- an optical chamber
- a battery charger
- a package containing 2 screws and 2 washers for fastening the optical chamber to the structure
- manual for use and maintenance
- conformity certificate

If you receive erroneous parts, or notice shortages or damage, contact the distributor. Keep the package, including the original packing material, in case you need to send the product for repairs.

HOW TO ASSEMBLE THE DEVICE

Open the crate from the top.

Remove the parts taking care not to cause violent impacts and damage.

Take the column and unscrew the two pivot screws, remove the washers and the stop disk, noting their position.

Insert the plastic cover on the base and replace the stop disk and washer on the column.

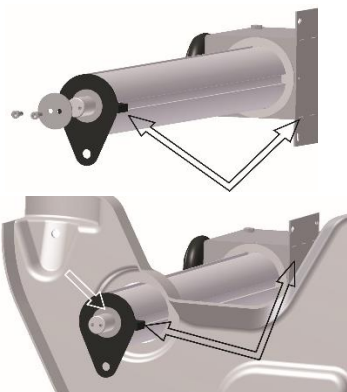

PREPARATION OF THE DEVICE

Insert the base and reassemble the screws and the washer with 2 holes. Tighten the two screws so as to obtain the desired friction in rotation of the column, with constant attention to the orientation of the column and stop disk.

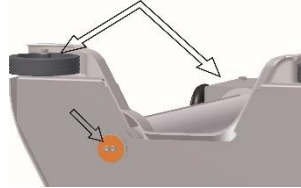

Return the structure to the upright position, check the correct orientation between the base and the column and check column rotation.

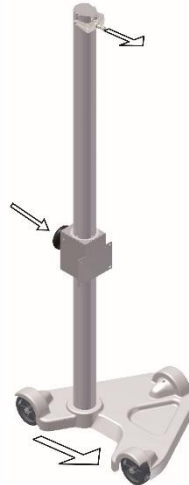

Remove the optical chamber from the carton and fasten it to the structure using the 4 screws and washers supplied.

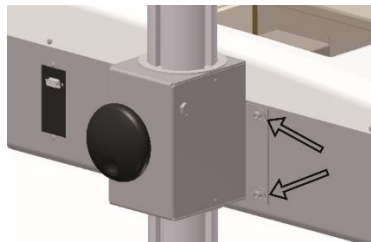

Remove the visor from the carton, screw it onto the support and tighten with a tool, using the hole on the pivot.

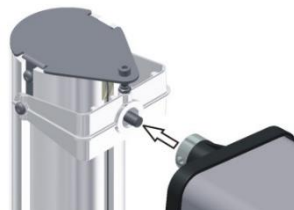

PREPARATION OF THE DEVICE

WORK SURFACE

During the headlight test the floor surface must be level. If this is not possible, the headlight tester should be positioned on a surface with a uniform slope, in any case not exceeding 0.5%. Do not test headlights on floors that are not perfectly regular and level, as the measurement might not be accurate.



INSTALLATION

Position the headlight tester in the work zone. Check the position of the level inside the optical chamber and, if it is not aligned, adjust the position of the optical camera using the screws that fasten it to the column.

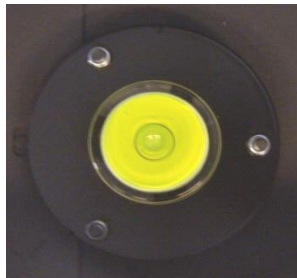

There is a second adjustment system on the base:

slightly loosen the screw fastening the wheel and adjust the tilt using the screw above it, then tighten the screw fastening the wheel.

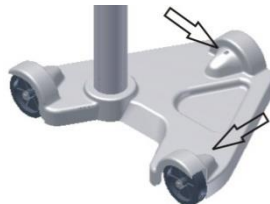

GENERAL SAFETY RULES

The following rules must be followed carefully to prevent damage to the operator and device.

- Read the device labels, do not cover them for any reason, and replace them immediately if they should be damaged.
- The device should only be used by authorized personnel, trained in its use.
- Do not use the device in an explosive atmosphere.
- The working environment should be dry and sufficiently ventilated.
- When moving the device, pay attention to other people, especially children, in the vicinity.
- Do not bump shelves or scaffoldings where there may be a danger of falling objects: you and the device could be damaged.
- The storage temperature should be between -5° and $+55^{\circ}\text{C}$.
- The working temperature should be between $+5^{\circ}$ and $+45^{\circ}\text{C}$.
- Provide an adequate exhaust system for the exhaust gas, since the headlight test must be performed with the engine of the motor vehicle running. Accidental inhalation of carbon monoxide can cause serious damage to the organism, with a fatal outcome in some cases. Contact our agent in your zone, who can indicate the most suitable system for your company.
- Do not leave the headlight tester in the sun or in the immediate vicinity of hot objects like heaters, radiators, etc.
- Do not leave the headlight tester out in the rain or in an excessively damp place as its electronic circuits could be damaged.
- If the headlight tester will not be used for a long period, we recommend that you cover it with its dust cover (optional).
- There is a battery in the headlight tester that could cause a fire or explosion hazard if handled improperly. To prevent this risk to not heat or use open flames near the battery and, when replacing it, use one with the same characteristics.
- When you encounter any malfunction in use of the device, contact the retailer or send the device to the nearest service center.
- The headlight tester has to be serviced only by a authorized and trained factory technicians.
- In case of parts replacements, order ORIGINAL replacement parts from a concessionaire or authorized retailer.
- Tampering with any part of the device will invalidate the warranty.**

PREPARATION

PREPARATION OF THE VEHICLE

Make sure the headlights are clean and dry. If the vehicle is equipped with a headlight aligner, set in on "0". Eliminate anything that could affect the correct position of the vehicle: mud, snow, ice, etc. Straighten the car wheels. Make sure the vehicle does not have any distortions of the frame. Make sure the tires are inflated at the correct pressure. Start the engine and perform the test. In case of vehicles with pneumatic suspension, start the engine five minutes before starting the test and proceed with the engine running.



CAUTION!

When operating in an enclosed space with the engine on it is essential to evacuate the toxic gasses produced by combustion. We recommend using a specific fan for exhaust fumes.

WORK SURFACE

During the headlight test the floor surface must be level. If this is not possible, the headlight tester should be positioned on a surface with a uniform slope, in any case not exceeding 0.5%. Do not test headlights on floors that are not perfectly regular and level, as the measurement might not be accurate.



CONNECTIONS

On the right side of the optical chamber is a button for switching the device on and off, an RS232 connector for communication and a system for updating the software by means of a USB port.

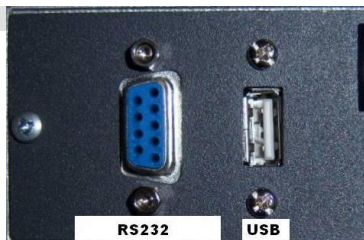

CAUTION!



If, when the device is switched on, the symbol for BATTERY DISCHARGED is displayed, connect the battery charger supplied to the outlet on the side of the optical chamber and let it charge for at least 12 hours; you can perform the test even with the battery charger on but the battery is not charged while the test is going on.

ALIGNMENT TO THE VEHICLE

POSITIONING

Place the headlight tester in front of the right headlight of the vehicle at a distance of about 20 cm-50 cm, measure the height from the floor to the center of the beam and adjust the optical chamber to the corresponding height using the graduated scale placed on the column. Use the upper part of the sliding shoe as an index of the scale.



ALIGNMENT WITH THE MIRROR VISOR

Locate two details, on the front of the vehicle, that are perfectly symmetrical between them (for example the top of the windshield or the headlights themselves)., turn the optical chamber until, when you look in the mirror, the two reference points meet the black line stenciled on the mirror.

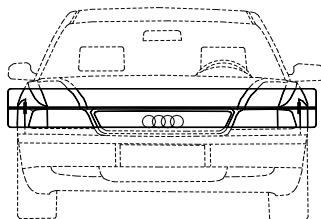

OK

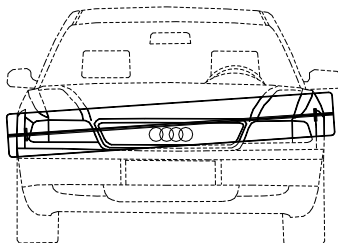

NO

ALIGNMENT TO THE VEHICLE

ALIGNMENT WITH THE LASER VISOR

The operator and the designer of the work island must be aware of the risks deriving from the laser. The island must absolutely not be in the transit area, it must be well marked and delimited by a yellow strip and possibly fenced with special barriers.

Check that there are no people in the test area, unlock the column using the pedal, rotate the viewer downwards and turn it on

Look for two details in the front of the vehicle, for example the two headlights themselves, rotate the optical chamber until the two reference points coincide with the line projected by the viewer and block the column.



CAUTION !

Switch off the laser immediately before proceeding with the other operations, both checking and adjusting the headlight

The line laser is in Class 2 with a wavelength of 520 nm (nanometers) and a power of <math><1\text{ mW}</math> (milliwatt) for which the direct observation of the beam can be dangerous with the aid of amplifying observation optics such as binoculars .. For them an accidental exposure is not considered dangerous since, being in the visible, the eyelid reflex does not allow an exposure higher than 0.25 sec.

HEADLIGHT TEST

PREPARATION

SWITCH ON THE HEADLIGHT TESTER ON with the on/off button on the side.

Wait a few seconds for local control of the device and loading of the process software.

- OPTIONS MENU

See the section on service and maintenance.

- APPLICATION MENU

Press the TOUCH button for the applications; the device can perform two types of TEST:

- OFFICIAL

- FREE

The OFFICIAL test is enabled only when there is a connection with the station PC, with communication in RS232 mode.

The FREE test is enabled if there is no connection with the station PC.



SETTINGS

- type of vehicle being tested

- 2 headlights: "automobiles"
- 1 headlight: "motorcycles"
- 1 headlight, low beam only: "motorbike"

- type of headlight :

- asymmetrical
- symmetrical
- asymmetrical 90°
- DLA
- Matrix
- Matrix2
- ILS

- type of light:

- halogen
- Xenon
- LED

- headlight tilt:

- read at the top of the headlight the tilt indicated by the manufacturer, e.g. 1.2%, set the value using the + and - key.

- height of headlight from ground:

- set the value using the + and - key.

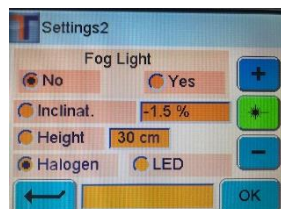
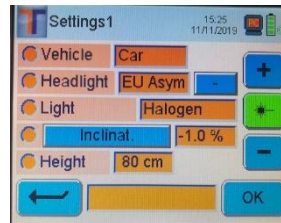

HEADLIGHT TEST

TEST OF THE LOW BEAM HEADLIGHT

The display now shows the type of vehicle (2 headlights) the type of headlight (low beam) and the side (right).



Switch on the RIGHT LOW BEAM headlight of the vehicle

to be tested, and press .

Wait a few second and check for the appearance of the borderline of the luminous beam

Now the status of the headlight is displayed (high \uparrow , low \downarrow , to the right \rightarrow , to the left \leftarrow , centered OK (dot at the center colored green) , and the light intensity.

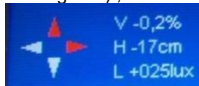

The position of the line at the center of the tolerance limits with change of the color from red to green is the sign that the headlight is correctly CENTERED.

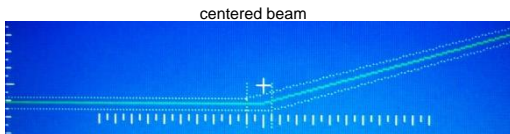

Press  to proceed to control of the headlight in Real mode.

NOTE: This screen displays the image of the luminous beam projected on the internal screen to the optical box and you can check the position in REAL mode.

Premere il tasto  e passare al controllo del faro successivo.



Not centered beam



centered beam

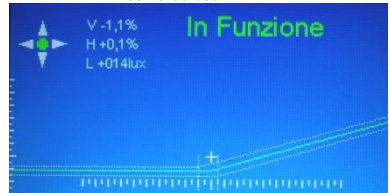

HEADLIGHT TEST

HIGH BEAM TEST

Now the device is ready for checking the right high beam



Turn on the RIGHT HIGH BEAM headlight of the vehicle

under test and press the button .

Wait a few seconds and check the appearance of the point of maximum intensity of the high beam.

The position of the point in the center of the boundaries of the tolerance allowed with the variation of the color from red to green is a correctly centered headlight tester sign.

centered beam

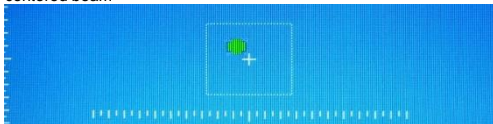

Press the button  key to proceed to control of the headlight in Real mode.

NOTE: This screen displays the image of the luminous beam projected on the internal screen to the optical box and you can check the position in REAL mode.

Press the button  to proceed to control of the next headlight.

Proceed now to the left side of the vehicle and repeat the test sequence.

OFFICIAL TEST: At the end of the procedure the device will send the data to the PC via communication protocol RS232.
FREE TEST: On models with the printer incorporated, the test results are printed when you press PRINT.



Not centered beam

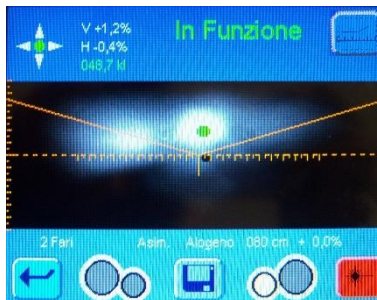
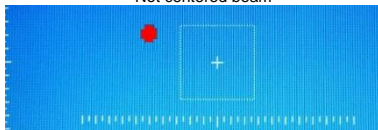

CAUTION!

When using the headlight tester in a mobile station (on rubberized wheels), after positioning on the left headlight check the alignment again through the visor.



HEADLIGHT BEAMS WITH INTELLIGENT FUNCTIONS

Projectors equipped with Dynamic Light Assist (DLA)

The following illustrations show the measurements of the headlights equipped with Dynamic Light Assist (DLA).

Screen configuration for left DLA projector

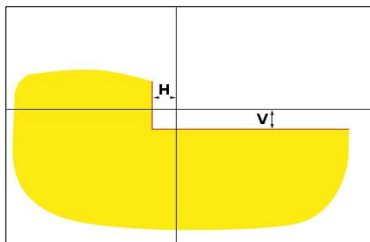

Screen configuration for right DLA projector

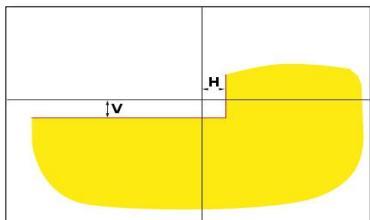

"H": deviation of the edge in the horizontal direction from the median. The value is always shown as an absolute value. Possible units: %, cm / 10 m, degrees

"V": deviation of the edge in the vertical direction from the median. The value is always shown as an absolute value. Possible units: %, cm / 10 m, degrees

! Pay particular attention to the accurate alignment of the headlight. Only once this has been done can the headlamps be adjusted in such a way that no other road user is dazzled.

! To adjust the headlamps with Dynamic Light Assist (DLA), it is necessary to put the headlights in basic settings mode using the diagnostic device to generate a test pattern. Only in this way are tests and adjustments possible!

! Vehicle condition according to manufacturer's specifications.



In the "Settings" menu in the "Lighthouses" function, select DLA.

HEADLIGHT BEAM WITH INTELLIGENT FUNCTIONS

When all other settings are correct, press "OK".

Connect the diagnostic device and set the headlights to the basic settings.

Position the headlight tester in the center of the left beam and check the parallelism with the vehicle using the laser visor.

For exact positioning in front of the projector, use the integrated cross laser.

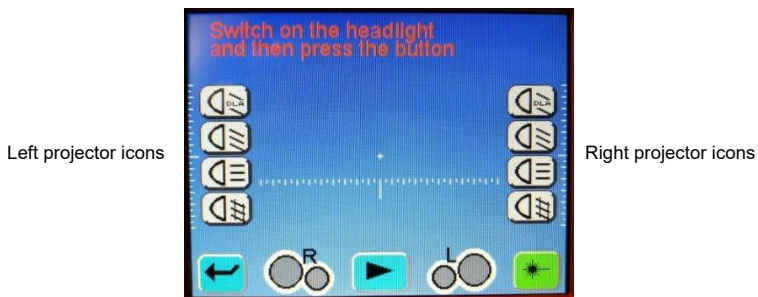

The icon  changes to the selected beam symbol. To start the test press this button.

The profile of the right DLA projector is shown.



if necessary, adjust the headlamps so that the measuring lines run centrally within the tolerance range. Correct adjustment is indicated by a green marking on the measurement lines.

Press the button  (Save).

Adjust the projector on the opposite side in the same way.

Then check the alignment of the dipped beam headlamp.



CAUTION! – Check the DLA projector!

At the end of the adjustments, a check of the dipped beam must be carried out. The adjustment of the horizontal deviation of the projector cannot be further adjusted during the check. Only vertical deviation adjustment is allowed.

HEADLIGHT BEAM WITH INTELLIGENT FUNCTIONS

Projector with MATRIX function

The following illustration shows the measurements for projectors with Matrix function.

Reading the Matrix function of the left projector

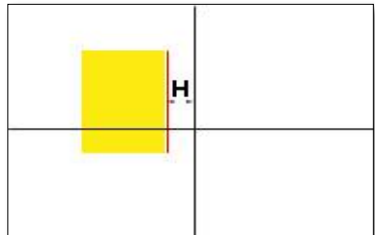

Reading the Matrix function of the right projector

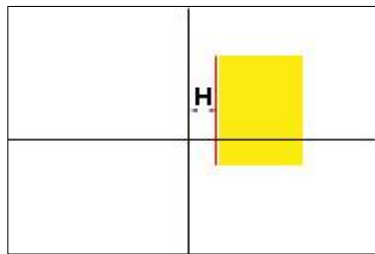

"H": deviation of the luminous edge in the horizontal deviation from the median. The value is always shown as an absolute value in minutes of degree.

HEADLIGHT BEAMS WITH INTELLIGENT FUNCTIONS

! The LED Matrix projector must be calibrated with a diagnostic device.

! First, adjust the low beam. The calibration of the high beam function of the Matrix beam is shown below.

! Take note of the test and adjustment prerequisites of the vehicle manufacturer.

After the following activities, the Matrix projector needs to be calibrated:

- The position of the headlight has been changed (removal and installation, loosening of the mounting screws).
- The power module for the Matrix projector has been replaced.
- The front camera for assistance systems has been removed and installed.
- The windshield has been removed and installed.
- The rear axle track has been adjusted.
- "no or incorrect basic configuration / adaptation" was entered in the error memory of the projectors.

In the "Settings" menu in the "Beam" function, select Mx



When all other settings are correct, press "OK".

Position the headlight beacon in the center of the left headlight and check the parallelism with the vehicle using the laser viewer.

i Cover the projector with a thin sheet of paper to facilitate better positioning at the reference segment.

For exact positioning, use the built-in cross laser.

Connect the diagnostic device and set the headlights to the basic settings.

Follow the instructions in the workshop manual for calibrating the headlamps.

Check the headlight adjustment in the low beam mode.

After this, you will be asked to determine / read and enter the angle value on the edge of the internal segment of the projector by setting the beam.

! No mechanical adjustment of the headlamps is necessary.

HEADLIGHT BEAMS WITH INTELLIGENT FUNCTIONS

Select the Matrix button.



Icons of the left projector

Icons of the right projector

The icon  changes to the selected beam symbol. To start the test, press this symbol.

The profile of the right Matrix projector is displayed.



Read the edge angle value of the internal reference segment (HL) and access the diagnostic device. Pay attention to the (+/-) signs when doing this.

Press the button  (Save).

Test the headlight on the opposite side of the vehicle in the same way after the OK from the diagnostic device.

The diagnostic device information follows to complete the calibration.

After the calibration is complete, read the error memory and remove / eliminate the errors present, if applicable.

HEADLIGHT BEAMS WITH INTELLIGENT FUNCTIONS

Projectors with Matrix2 function

The following illustration shows the measurements for projectors with Matrix function.

Reading the Matrix2 function of the left projector

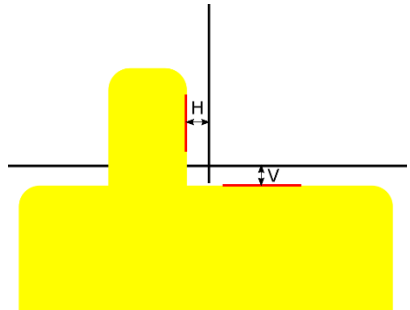

Reading the Matrix2 function of the right projector

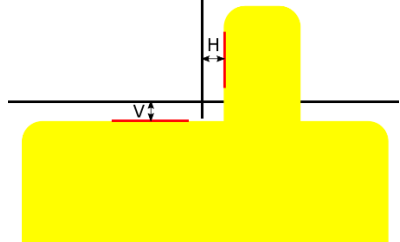

"H": deviation of the luminous edge in the horizontal direction from the median. The value is always shown as an absolute value in minutes of degree.

"V": deviation of the edge in the vertical direction from the median. The value is always shown as an absolute value in minutes of degree.

HEADLIGHT BEAMS WITH INTELLIGENT FUNCTIONS

! The LED Matrix projector must be calibrated with a diagnostic device.

! First, adjust the low beam. The calibration of the high beam function of the Matrix2 beam is shown below.

! Take note of the test and adjustment prerequisites of the vehicle manufacturer.

After the following activities, the Matrix2 projector needs to be calibrated:

- The position of the headlight has been changed (removal and installation, loosening of the mounting screws).
- The power supply module for the Matrix2 projector has been replaced.
- The front camera for assistance systems has been removed and installed.
- The windshield has been removed and installed.
- The rear axle track has been adjusted.
- "no or incorrect basic configuration / adaptation" was entered in the error memory of the projectors.

In the "Settings" menu in the "Beam" function, select Mx2:



When all other settings are correct, press "OK".

Position the headlight tester in the center of the left headlight and check the parallelism with the vehicle using the laser visor.

i Cover the projector with a thin sheet of paper to facilitate better positioning at the reference segment.

For exact positioning, use the built-in cross laser.

Connect the diagnostic device and set the headlights to the basic settings.

Follow the instructions in the workshop manual for calibrating the headlamps.

Check the headlight adjustment in the low beam mode.

After this, you will be asked to determine / read and enter the angle values on the edges of the projector segment by setting the beam.

HEADLIGHT BEAMS WITH INTELLIGENT FUNCTIONS

Select the Matrix2 button

Icons of the left projector projector

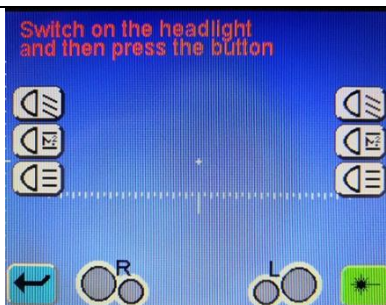

Icons of the right

The icon  changes to the selected lighthouse symbol. To start the test, press this symbol.

The profile of the right Matrix projector is displayed.



Read the corner values of the edges of the reference segment H and V and access the diagnostic device. Pay attention to the (+/-) signs when doing this.

Press the button  (Save).

Test the headlight on the opposite side of the vehicle in the same way after the OK from the diagnostic device.

The diagnostic device information follows to complete the calibration.

After the calibration is complete, read the error memory and remove / eliminate the errors present, if applicable.

HEADLIGHT BEAMS WITH INTELLIGENT FUNCTIONS

Light system without glare (ILS)

The following illustration shows the most important measurement dimensions for Ford LED headlamps with dipped beam (ILS).

Reading the ILS function of the left projector

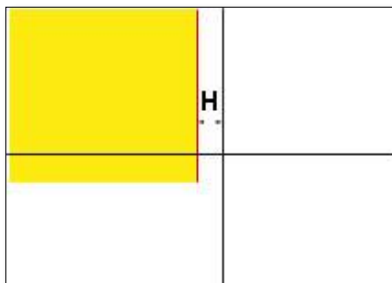

Reading the ILS function of the right projector

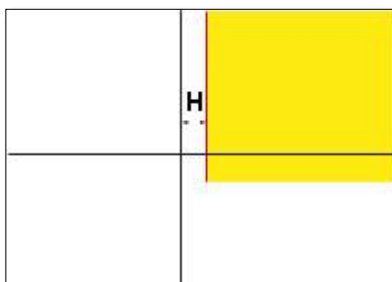

"H": deviation of the edge in the horizontal direction from the median. The value is always shown as an absolute value. Possible units: %, cm / 10 m, degrees.

! Pay particular attention to ensure accurate alignment of the headlight. Only once this has been done can the headlamps be adjusted in such a way that no other road user is dazzled.

! To adjust the headlamps with dipped beam (ILS), it is necessary to put the headlights in the basic settings mode using the diagnostic device to generate a test model. Only in this way are tests and adjustments possible!

! Vehicle condition according to manufacturer's specifications.

In the "Settings" menu in the "Beams" function, select ILS.

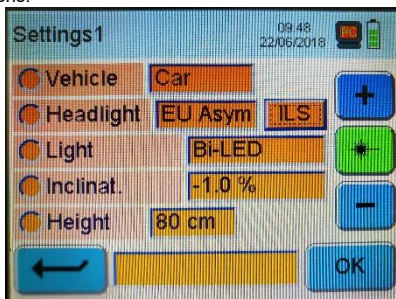

HEADLIGHT BEAMS WITH INTELLIGENT FUNCTIONS

When all other settings are correct, press "OK".

Position the headlight tester in the center of the left beam and check the parallelism with the vehicle using the laser visor.

I For exact positioning in front of the projector, use the built-in cross laser.

Connect the diagnostic device.

Set the headlights to "basic settings" via the diagnostic device.

The projector is now in dipped beam setting mode.

Test the headlight settings in low beam mode.

Test the headlamp on the opposite side of the vehicle in the same way.

Configuration of the low beam is complete.

Follow the instructions of the diagnostic device and set the headlights to "Basic main beam settings".

The headlamp is now in high beam setting mode and a special test pattern is generated.

Place the beacon in the center of the beam.

For exact positioning in front of the projector, use the built-in cross laser.

Select the ILS icon.

Icons of the left projector



Icons of the right projector

The icon  changes to the selected beam symbol. To start the test, press this symbol.

The profile of the ILS projector is shown.



If necessary, adjust the headlamps so that the measuring lines run centrally within the tolerance range.

Correct adjustment is indicated by a green marking on the measurement lines.

Select the button  (Save).

Adjust the projector on the opposite side in the same way.

HEADLIGHT BEAMS WITH INTELLIGENT FUNCTIONS

Projectors with Asymmetric 90° function

The following illustration shows the measurements for projectors with an asymmetrical 90° function.

reading of the asymmetrical 90° function of the projector

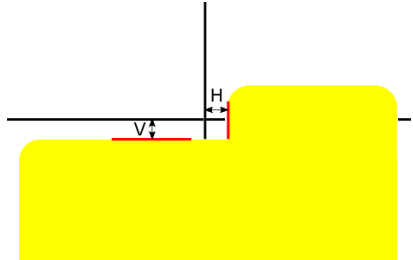

"H": deviation of the luminous edge in the horizontal direction from the median. The value is always shown as an absolute value in degrees.

"V": deviation of the edge in the vertical direction from the median. The value is always shown as an absolute percentage value.

HEADLIGHT BEAMS WITH INTELLIGENT FUNCTIONS

! Take note of the test and adjustment prerequisites of the vehicle manufacturer.

After the following activities, the 90 ° asymmetric projector must be calibrated:

- The position of the headlight has been changed (removal and installation, loosening of the mounting screws).
- The power supply module for the 90 ° asymmetrical projector has been replaced.
- The front camera for assistance systems has been removed and installed.
- The windshield has been removed and installed.
- The rear axle track has been adjusted.
- "no or incorrect basic configuration / adaptation" was entered in the error memory of the projectors.

In the "Settings" menu in the "Headlights" function, select Asym 90 °

In the lower part you will have to enter the values in% of vertical and large inclination for the horizontal orientation using the Inclinat./Deviation button

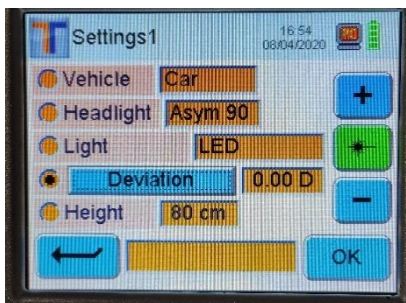
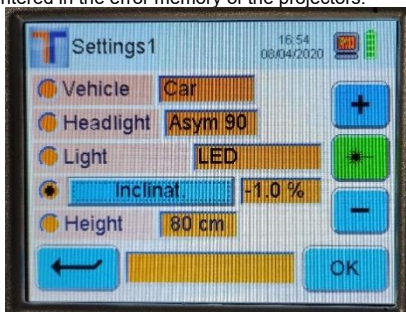

When all other settings are correct, press "OK".

Position the headlight beacon in the center of the headlamp and check the parallelism with the vehicle using the laser viewer.

i For exact positioning, use the built-in cross laser.

Connect the diagnostic device and set the headlights to the basic settings.

Follow the instructions in the workshop manual for calibrating the headlamps.

Check the headlight adjustment in the low beam mode.

After this, you will be asked to determine / read and enter the angle values on the edges of the projector segment by setting the beam.

HEADLIGHT BEAMS WITH INTELLIGENT FUNCTIONS

Select the low beam button

Icons of the left projector
projector

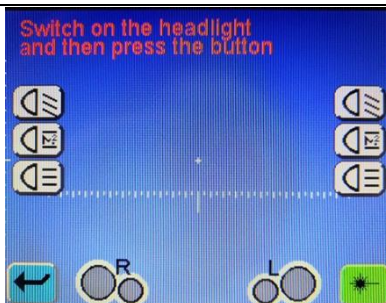

Icons of the right

The icon  changes the symbol of the selected beam. To start the test, press this button.

The projector profile is displayed.



Read the corner values of the edges of the reference segment H and V and access the diagnostic device. Pay attention to the (+/-) signs when doing this.

Press the button  (Save).

Test the headlight on the opposite side of the vehicle in the same way after the OK from the diagnostic device.

The diagnostic device information follows to complete the calibration.

After the calibration is complete, read the error memory and remove / eliminate the errors present, if applicable.

SUPPLEMENTARY INSTRUCTIONS

REPLACEMENT OF LASER VISOR BATTERIES

Switch off the laser before open the visor.
Unscrew the two screws on the lid of the laser visor and replace the 3 penlight batteries size AA 1.5V, respecting the correct polarity, close the visor and fasten the lid with the screws provided.

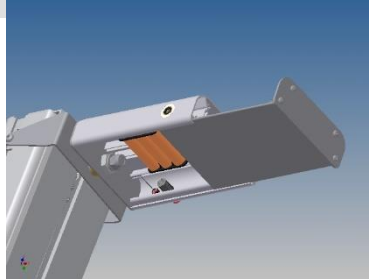

CLEANING AND MAINTENANCE

The device does not require particular maintenance other than normal cleaning with a damp cloth (water or normal detergent).



CAUTION!

Do not use nitro solvents

DEMOLITION AND DISPOSAL

The device is mainly composed of steel.

Other parts:

in plastic, some parts

in cardboard and paper, packing and documents

the device is painted with scratch-resistant epoxy powder.

In disposing of the device, comply with the provisions of the local authorities.

WARRANTY

In case of evident and acknowledged manufacturing defects of any product, it will be repaired or replaced under the warranty only if the claim is made and documented within 8 days of delivery. Returns of defective goods will be accepted only FREIGHT PREPAID, while all returns CARRIAGE FORWARD will be rejected. All other forms of reimbursement are excluded.

